

Final Report:

Development of GIS Maps for Southeast Florida Coral Reefs

DEP AGREEMENT No. G0057; NOAA AWARD NA16OZ2440



For the

Fish and Wildlife Research Institute



This project and the preparation of this report and data files were funded in part by a Coastal Zone Management grant from the U.S. Department of Commerce, National Oceanic and Atmospheric Administration Office of Ocean and Coastal Resource Management, through an agreement/contract with the Coastal and Aquatic Managed Areas Program of the Florida Department of Environmental Protection. The total cost of the project was \$314,651, of which \$314,651 was provided by the National Oceanic and Atmospheric Administration.

Executive Summary:

The present report outlines the results of an integrated mapping project undertaken to provide a habitat map of the shallow Broward County seafloor between the 0m and 35m contour. The study area stretched from Golden Beach in northern Dade County to just north of the Palm Beach County line. To produce this map and assure its compatibility with other, in particular NOAA, mapping products, a series of data were integrated. Data types included Laser Airborne Depth Sounder (LADS) bathymetry, multi- and single-beam bathymetry, acoustic seafloor discrimination, ecological assessments, and groundtruthing. The method used for acoustic seafloor discrimination was based on the first echo and its associated tail, and on the second echo returns of a 200 kHz signal. Two survey systems were employed: QTC View and Echoplus. A series of controlled experiments and field verifications indicated that it was possible to distinguish acoustically between different scattering classes that correlated to different seafloor types.

For the production of the final map, information obtained from LADS bathymetry, NOAA classification and scattering classes obtained by QTC View and Echoplus was fused. The final map showed three well-developed linear reef complexes, a series of deep and shallow ridges believed to be old shorelines, a large sand area between the middle and outer reefs, and a considerable amount of colonized pavement. Due to the lack of distinct geomorphologic zones, the maps were based solely on habitat as defined by the NOAA biogeography program; however distinctions between areas such as linear reef, spur and groove, and colonized pavement were based on benthic cover (as seen by acoustic seafloor discrimination and biological transects) and geomorphology. The outer linear reef was subdivided into four habitats: aggregated patch reef, spur and groove, linear reef and deep colonized pavement. The area east of the outer linear reef consisted of a very patchy environment with large patches of reef interspersed amongst the deep sand. These were more prevalent close to the reef and tapered off eastward, becoming sandier. The spur and groove, linear reef, and deep colonized pavement comprised the outer reef and were separated mainly based on geomorphology. The outer reef was separated from the middle linear reef by a wide sandy plane (deep sand), which was characterized overall by a different scattering class in QTC View than the shallow sand found inshore. Acoustic ground discrimination identified patches of higher scatter and lower scatter amongst the outer, middle, and inner linear reefs suggesting distinct benthic cover between these structures. The eastern boundary of the middle reef was distinct and easily mapped whereas acoustic discrimination aided in determining the western boundary. The inner reef was the least distinct reef as it is not a mature reef. Much of this reef is patchy growth atop an inshore ridge and reef zonation is absent. Acoustic ground discrimination suggested that patches of higher versus lower scatter existed between and within the linear reefs, indicating that dense fauna is patchily distributed. Shoreward of the inner reef, another sand area or a mixture of sand and colonized pavements were found. Several nearshore ridges were mapped that could be classified as linear reef habitat, but were thought to be of non-reefal origin. Therefore these structures were mapped separately even though similar habitat comprises the inshore ridges, the inner

linear reef, and the shallow colonized pavements. Excluded habitats such as submerged vegetation and large rubble zones were not detected sufficiently enough to be mapped during this effort.

Groundtruthing by way of underwater video drop cameras and *in situ* biological assessments aided in the refinement of the mapping categories. Accuracy assessment of an independent grid of target points showed the map to have a users accuracy between 83% and 97% and a producers accuracy between 81% and 95%. These are acceptable accuracies and compare similarly to NOAA published map accuracies.

In conclusion, the amalgamation of several mapping approaches and data products provided a representative map of Broward County submarine habitats that was accurate to a very satisfactory level. The results of this survey are a good example of how similar mapping products can be attained through different means. The method employed to map Broward County appears to have equally and accurately illustrated the benthic community as more traditional methods like photo interpretation. Similar methodology should be used in other areas where photo interpretation is not feasible due to either absence of data or the turbidity of the water.

TABLE OF CONTENTS:

Introduction.....5

Methodology

Principles of acoustic ground discrimination.....8

Differences in two applied systems.....10

 QTC View.....11

 Echoplus.....13

Work flow.....16

 Selection of signal frequency and transducer.....16

 Survey safety.....18

 Data coherence.....18

 Data processing.....19

Data coherence and sensor drift.....19

Biological investigations to support acoustic classifications.....20

Study area.....20

Ecological sampling.....21

Photo analysis22

Results

Justification of survey planning and line orientation.....22

Survey tracklines.....23

Survey results in QTC View.....23

Survey results in Echoplus.....28

Evaluation for internal consistency of data.....30

Data gridding and interpolation.....32

Integration of data types.....34

Biological information relevant to mapping classes.....36

Final mapping categories.....42

Description of mapped reef habitats.....43

Groundtruthing.....61

Accuracy assessment.....61

Discussion64

Conclusions.....66

References.....67

INTRODUCTION

Under NOAA Award NA16OZ2440, the Florida Fish and Wildlife Research Institute (FWRI), with the assistance of Nova Southeastern University, is required to map the coral reefs and other benthic habitats found off Broward County and the very northern portion of Dade County (Figure 1).

The overall aim of the project was to fill gaps in coverage of knowledge and monitoring of coral reef ecosystems nationwide and thus complemented the goals of the Coral Reef Conservation Act, NOAA, Executive Order 13089, and the National Action Plan.

The produced digital maps are to be included in the South Florida Electronic Area Contingency Plan that FWRI is developing jointly with the US Coast Guard to help support oil spill response and planning.

The maps are also supposed to support state and county permitting activities related to sand mining and the minimization of impacts by submarine construction and excavation, such as pipeline routings etc.

Data will also be included in large-format maps to be shown on a future Broward County Boating and Angling Guide, which is to be produced by FWRI. Such guides are to include extensive information about marine resources and their protection and conservation.

Benthic data will be added to the SEAMAP Bottom Mapping Project, which consists of various GIS produced by the Atlantic States Marine Fisheries Commission and the States of North Carolina, South Carolina, Georgia, and Florida. The aim of the GIS is to identify essential fish habitat.

Finally, the maps will be used for local and State-sponsored monitoring programs to assist in optimal site-selection.

In order to provide a product that is compatible with these goals, the following approach was taken:

- (1) Data were acquired from all available sources.
- (2) A complete bathymetric and acoustic seafloor discrimination survey based on single-beam sonar was run at 50m line-spacing over the entire area of Broward County.
- (3) Two different survey systems (QTCView, Echoplus) were used.
- (4) The acoustic data from these three areas were individually evaluated and split into four classes that represented all encountered substratum types.
- (5) All available biological data useful for the interpretation of large-scale patterns were used.
- (6) Where insufficient biological data were available, additional data were taken.

(7) All data sources were then integrated for the production of the final map.

Stipulated and provided products were:

- Geo-referenced maps depicting classified benthic habitat maps.
- Habitat classification compatible with other NOAA mapping products.
- Production of a GIS of data types.

Broward Survey Extent

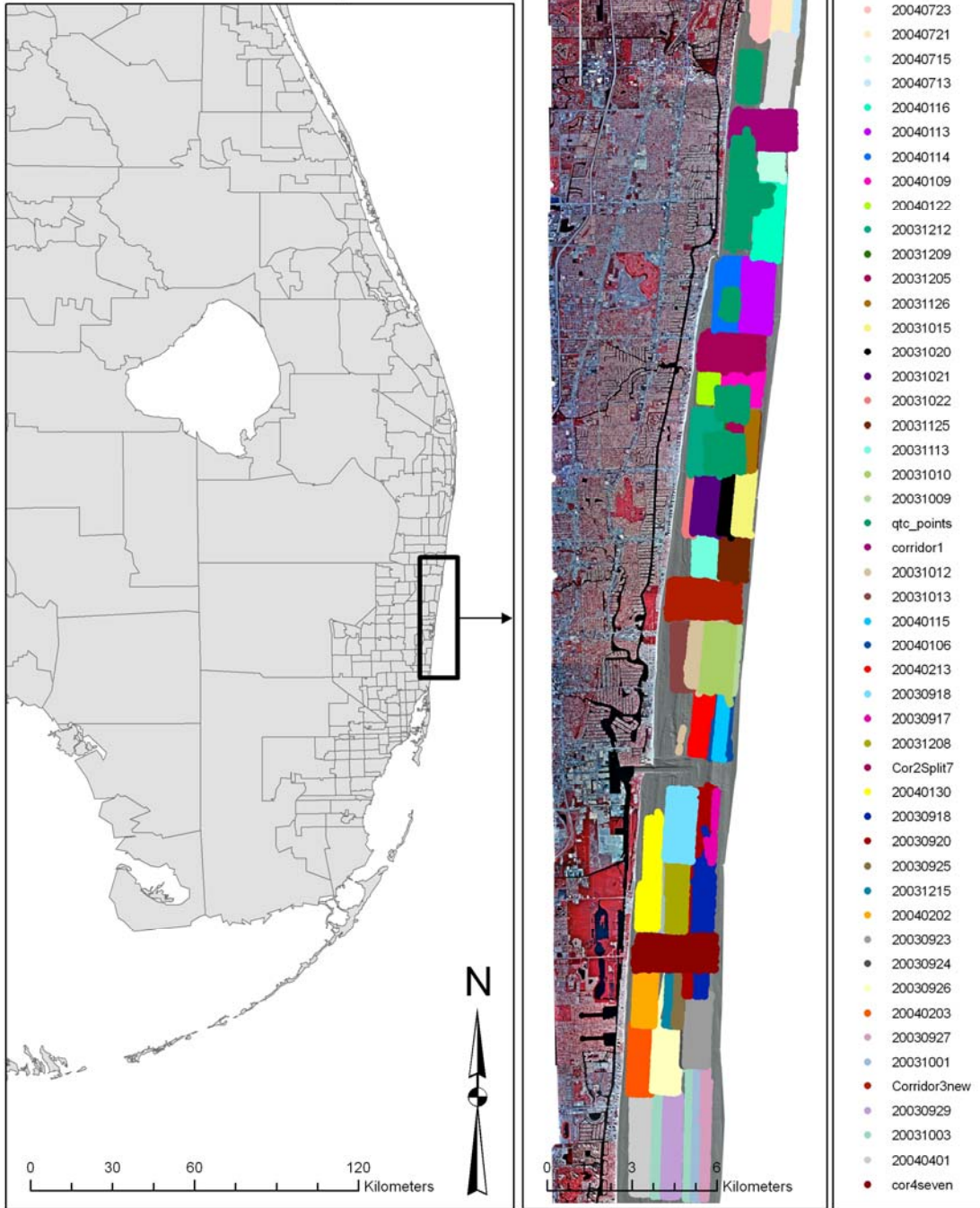

Figure 1: The study areas Broward County. The extent of this area stretches from Golden Beach in northern Dade County to southern Palm Beach County. The survey lines completed by NSU are superimposed in color.

METHODOLOGY

PRINCIPLES OF ACOUSTIC GROUND-DISCRIMINATION

The physical processes associated with acoustic bottom classification are as follows:

Sound (a “ping”, i.e. a signal consisting of a specified number of oscillations per second) is emitted from the source. This sound travels to the seabed, and the energy that encounters the seabed is reflected at the surface of the seabed and returned to the receiver. In the receiver, piezo-electric crystals transform the actual acoustic energy (manifested by alternating compressions and rarefactions of the medium which is, in our case, water) into electricity. These electrical pulses, once received, are digitized. The returning acoustic energy produces a first sharp peak (the timing of this first return, i.e. the traveling time of the sound in the water, is used to determine depth). Some energy enters the substratum and returns to the receiver as lower peaks arriving after the surface return. Some energy does not impinge on the seabed near nadir and is lost because it is scattered away from the receiver, or eventually reaches the receiver as backscatter. The energy contained in this backscatter is lower and it makes up the “tail” of the signal (see Figure 2). The rougher the seabed, the more diffuse scatter will occur and the more energy will return to the receiver. The smoother the seabed, the more specular the scatter, with that energy not returning to the receiver and being lost (no marked “tail” in the signal). Therefore, the length and energy-content of the signal-tail provides a good estimate of acoustic roughness of the surface sediment (including its biological cover). The higher the frequency of the signal, the more sound reflection is determined by bottom relief, rather than sediment parameters, because the shorter wave-lengths scatter more easily, and also on smaller objects.

The shape and the power of the returned echo can change considerably with depth. Thus, an important signal characteristic is independent of the seafloor. The deeper the seafloor, the more the echo gets “stretched” (this is because sampling is along a constant time axis, and not at equal angles). Thus echoes are transformed either to a reference depth, i.e. an average survey depth, or all axes are set to unity, which then “squashes” deeper echoes and “stretches” shallow echoes to the same length.

Because echo shapes can vary markedly even over small time-intervals, some survey systems, like the QTC View, consider it necessary to average at least a few signals (echo stacking) in order to produce a reliable estimate of echo shape. Stacking the echo shapes into envelopes of 5 echoes each, helps reduce the variability in echo shape which is partly due to vessel and sensor movement (roll and pitch) or electrostatic noise. While the stacking is important for the optimization of evaluated signal properties, it needs to be considered when calculating the ecological footprint during an operational survey. Because the vessel is moving, this stacking of several signals will increase the total footprint area that is being investigated. The severity of this change in ecological grain depends on ping-frequency and vessel-speed.

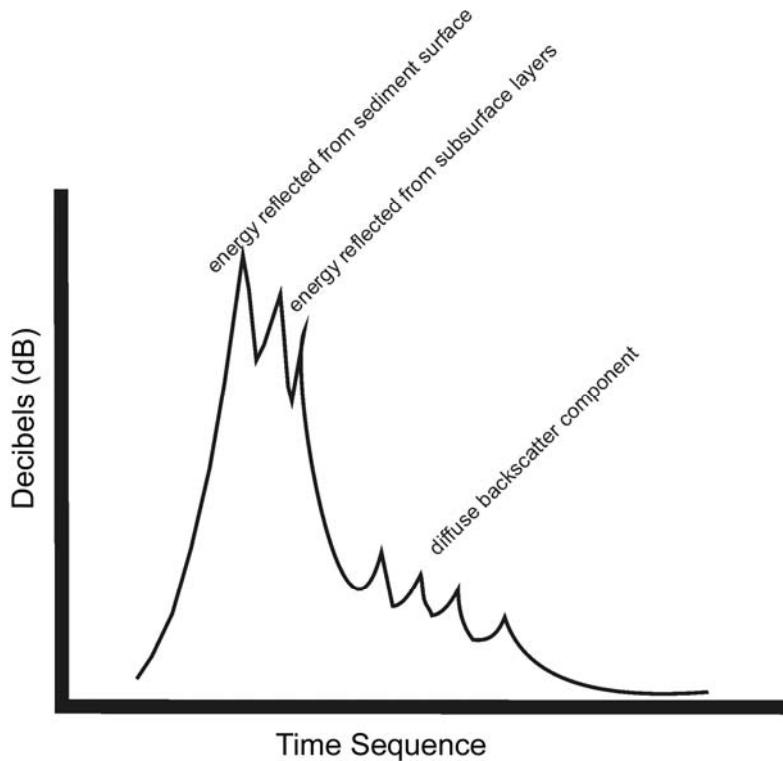

Figure 2: Conceptual diagram of an acoustic signal envelope. *QTC* View samples the entire signal, *Echoplus* time-gates sampling so that the surface and subsurface components of the signal are largely ignored.

Once the first echo has reached the surface, it is reflected and travels towards the seafloor again, where it is reflected another time to arrive back at the receiver. This second returning echo is termed a multipath echo. The usefulness of this second (and depending on energy, a third and fourth and so on) echo, and whether one decides to use it or not, depends on which underlying theory for its formation is used. The generation of this echo could be caused by the dominant ray paths undergoing scattering first at the seafloor (production of first echo), then at the surface, and then at the seafloor again (production of second echo). A competing theory claims that because of the presence of the sea surface, the configuration is actually bi-static, resulting in a virtual displacement of transmitter and receiver by twice the water depth (Figure 3). This would make the information contained in the second echo equivalent to the first echo. In both cases, the energy contained within the second echo depends on seafloor hardness; therefore this second echo can also be used to gain information about the seafloor.

In general, the quality of the first echo is higher, and careful QA/QC is applied before use of the second echo. Also, since waiting for two echoes takes twice the time as waiting for one echo, any system using it is limited to somewhat greater survey depth while a system exploiting only the first echo can survey to shallower depths (< 1 m).

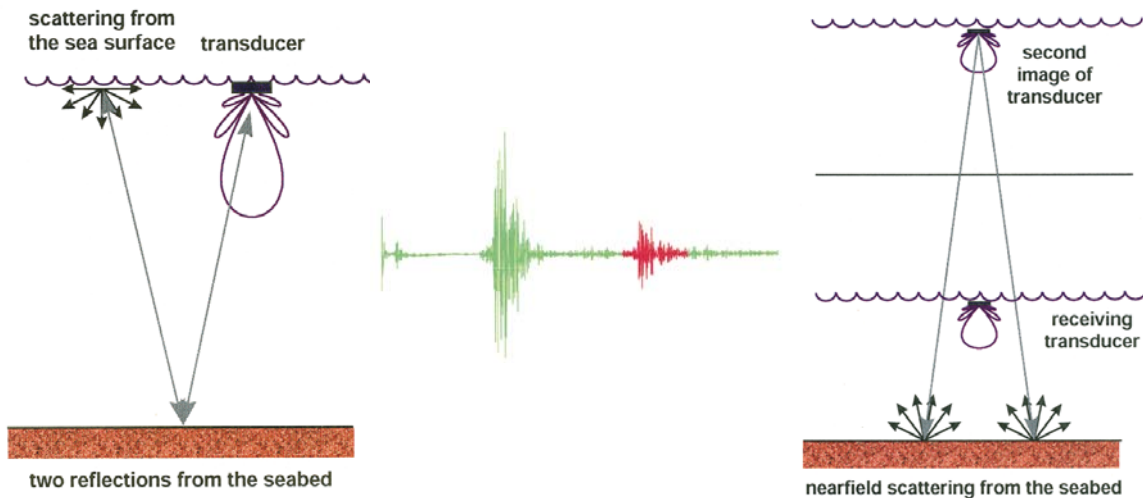

Figure 3: Scattering resulting in the second echo (red) and the two conflicting theories regarding the actual mechanism. The right hand image assumes bi-static configuration. Image from Echoplus User Manual.

DIFFERENCES IN TWO APPLIED SURVEY SYSTEMS

In the present surveys we used two different ground-discrimination systems:

- QTC View Series V, produced by Quester Tangent Corporation of Sidney, B.C., Canada.
- Echoplus of SEA (Advanced Products) LTD. of Bath UK, which is distributed by Seatronics, Aberdeen, U.K.

QTC View and Echoplus differ in the way the received signal is processed. QTC View processes the entire first echo, while Echoplus only processes the tail of the first echo plus the entire second echo (Figure 4). The logic for Echoplus's signal processing is to concentrate on backscatter, avoid surface and subsurface returns and to avoid contamination of backscattered energy with energy that has been reflected from directly below the transducer (Figure 5). This becomes important when the boat rolls, since the first echo leading edge is likely to be lost when the transducer is off vertical. The scattered trailing edge of the echo will largely remain constant under conditions of pitch and roll. However, while constancy of signal is gained, some information pertaining to surface and, if applicable (since it is frequency-dependent) sub-surface, is lost.

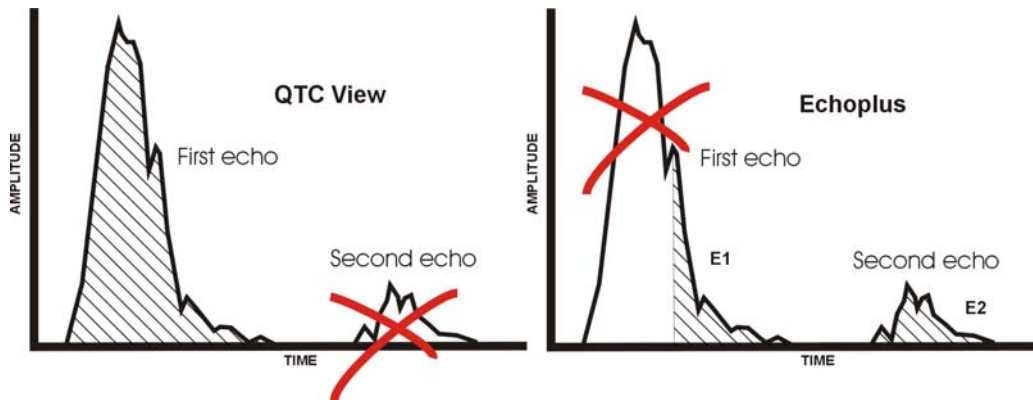

Figure 4: Cartoon of difference in signal processing between the QTC View and the Echoplus systems (modified from Hamilton 2001).

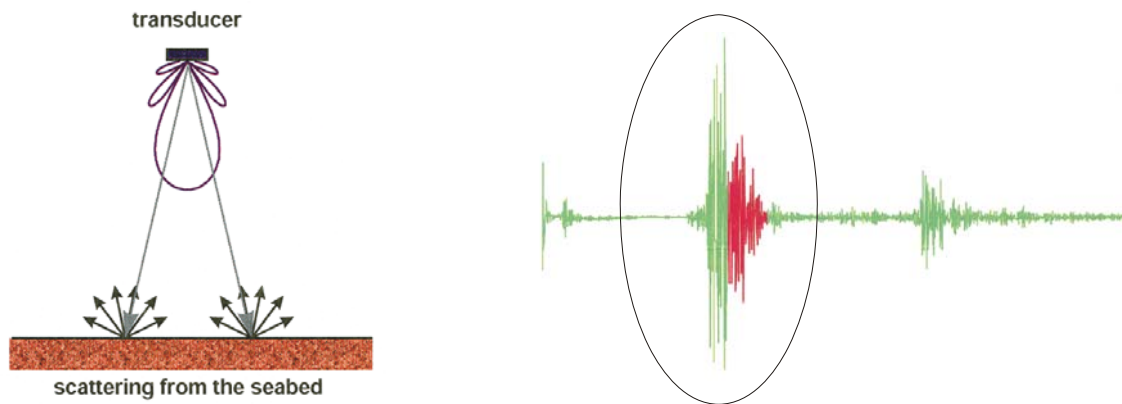

Figure 5: Scattering resulting in the first echo and the shape of the first echo (within the ellipse). QTC View uses almost the entire first echo information, Echoplus only the tail (in red). Image modified from Echoplus User Manual (Seatronics 2000).

THE APPLIED SURVEY SYSTEMS

QTC View

Acoustic habitat classification was performed using the QTC View Series V system (Figure 8), which consists of hydrographic survey hard- and software geared towards acoustic ground discrimination based on the shape of sonar returns. It is produced and sold by Quester Tangent Corporation of Sidney, British Columbia, Canada. It records the characteristics of the first echo to generate habitat classifications based on the diversity of scattering and penetration properties of different types of seafloor (Preston *et al.* 1999). The typical process of benthic habitat classification using QTC View Series V involves a hydrographic survey where raw acoustic data are collected as time-stamped digitized envelope of the first returning acoustic pulse. Differential GPS data using a Trimble AgGPS 132 that auto-corrected against nearby U.S. Coast Guard differential beacons and thus gave positioning accuracies between 0.9 and 1.5 m

(recorded on the GGA NMEA data string, that was logged) were collected in parallel to the digitized echo traces and carried the same time-stamp, based on GPS time. Data were processed in the software QTC Impact and were checked by the operator for correct time-stamps, correct depths and correct signal strengths. All signals that did not pass an appropriate level of quality control were discarded and not used for further processing. Data were displayed on a bathymetry plot, where recorded depths were checked against the blanking (minimum recordable) and maximum depths set for the survey and any faulty depth picks were removed manually before further processing.

As signal-producer, we used a Suzuki 5200 depth sounder with both a 50 and 200 kHz signal on a 10 Hz sending frequency, which was sampled by the QTC View software at a rate of 5 Hz. The acoustic transducers had beam widths of 42° and 12° respectively for the two sampling frequencies. The transducers were mounted on a swing-arm over-the-side, and were positioned 45 cm underneath the waterline.

In QTC Impact software, the returning echoes are digitized and subjected to several analyses that are not specified by the manufacturers, but are guarded as proprietary. Analyses in the literature (Hamilton 2001, Legendre *et al.* 2002) suggests that these analyses are done both in the time and frequency domains and include, but are not limited to, Fourier Analysis, Wavelet transforms, analysis for kurtosis, surface area, spectral moments and other variables. After being normalized to a range between 0 and unity, the 166 parameters calculated by previously mentioned (and possibly other) methods, are then subjected to Principal Components Analysis (PCA) in order to eliminate redundancies and noise. The first three principal components of each echo are then retained, according to the logic that these contain typically about 95% of the information (Quester Tangent Corporation 2002). Data points were then projected into pseudo-three-dimensional space along these three components, where they were then subjected to cluster analysis (Quester Tangent Corporation 2002).

Cluster analysis using a Bayesian approach is then performed within the software packet QTC Impact, which is companion software to the QTC View survey package. In the clustering, the user decides on the number of desirable clusters and also chooses which cluster is split how often. Clustering decisions of the user are guided by three statistics that are offered by the program called “CPI” (Cluster Performance Index), “Chi2” and “Score”. The user can either cluster to a predefined level (in the present survey we only split to five clusters since prior knowledge of the survey area and survey equipment caused us not to expect more groups) or to a point where further splitting has no more influence on either “Chi2” or “Score”, indicating the most appropriate number of acoustic classes in the given dataset was reached.

We used these statistics to create several levels of datasets that were tested against each other: one level with all data and all classes included, and several levels in which all data that did not fulfill specified quality control criteria (i.e. <90%, 60% confidence, <90%, 60% probability) and all classes that did not show clear spatial patterns, were culled. The discrimination accuracies of the datasets were then compared against each other. Datasets were reduced to three-column matrices consisting of a single *x,y* geo-referenced class category *z*. The trackplots for each data class were individually plotted to allow assessment of their spatial distribution. Classes that showed a preferential distribution in well-defined parts of the

survey area were considered to show promise for distinguishing different seafloor types. Classes that were found in comparable density across the entire survey area were considered to carry signals with no discrimination ability. Classes that were found to be redundant were iteratively removed from the dataset.

Reviews of the functioning of the system and critiques can be found in Hamilton *et al.* (1999), Hamilton (2001), and Legendre *et al.* (2002). After analysis was done using the QTC View clustering algorithm, we reprocessed analyses by splitting data using a k-means clustering algorithm on all stacked acoustic signals as characterized by their principal components values (PC1, PC2, and PC3). Code was written in Matlab 6.1. Legendre *et al.* (2002) suggested that k-means clustering might yield better results.

Echoplus

The Echoplus (Figures 6 and 7) is essentially a digital version of the older, and well known, RoxAnn (Hamilton 2001), which was extensively tested by Hamilton *et al.* (1999). It is produced by SEA (Advanced Products) in Bath, UK. The system is entirely self-contained and, according to the manufacturers, internally compensates for frequency, depth, power level and pulse length, and can therefore be used with any depth sounder. Pulse amplitude and length are measured on every transmission, the outputs are scaled, and absorption corrections are factored in. The first echo is then time-gated in a way that only its (backscatter-) tail is used for analysis along with the entire second echo (Figure 5). The measurements from first and second echo are collapsed into two indices, E1 and E2 for first and second echo respectively. The user has no influence on the formation of these indices and can only collect a georeferenced string of variables (x, y, E1, E2). The Echoplus was used with the same Suzuki 5200 depth sounder with both 50 and 200 kHz signals on a 10 Hz sending frequency as in the QTC View surveys. The sampling frequency cannot be exactly determined, since the system only allows logging of data that were considered satisfactory by system-internal QA/QC. Therefore, depending on conditions, actual logging frequency may vary, which makes accurate footprint determination difficult. The same acoustic transducers with beam widths of 42° and 12° respectively for the two sampling frequencies were used as for the surveys using the QTC View.

The data output by the Echoplus acquisition board (Figure 9) are collected in the survey software HYPACK (by Coastal Oceanographics Inc., Massachusetts) and then paired to differentially corrected GPS positions carrying the same time stamp. After data collection, the raw data are further processed. Raw acoustic signals are digitized and manipulated by different algorithms. In the Echoplus system, the entire shape of the backscattered impulse is collapsed in to a single numerical index. Two such indices are produced for each outgoing ping: an index for the first echo (E1), which is mainly determined by surface roughness, and an index for the second echo (E2), which is mainly determined by surface hardness. These indices are then cleaned using specially written routines in Matlab 6.1– all data above the 95th and below the 5th percentile are then rejected as outliers. All data are then normalized to the 95th percentile, giving all

data a range between 0 and 1. Clusters are determined by plotting first (E1) versus second return (E2) data in a scatterplot.

Echoplus surveys were performed using a 200 kHz transducer. The survey areas were so selected to overlap with the previous QTC View surveys.

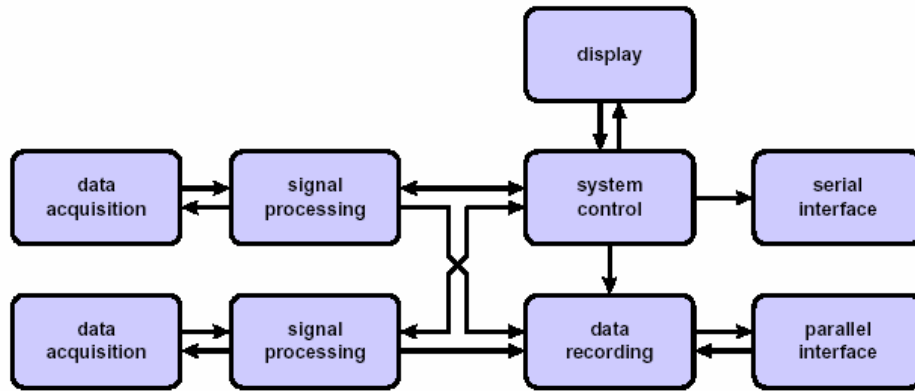

Figure 6: System architecture of the Echoplus seafloor discrimination system. Graphic from Seatronics (2000).

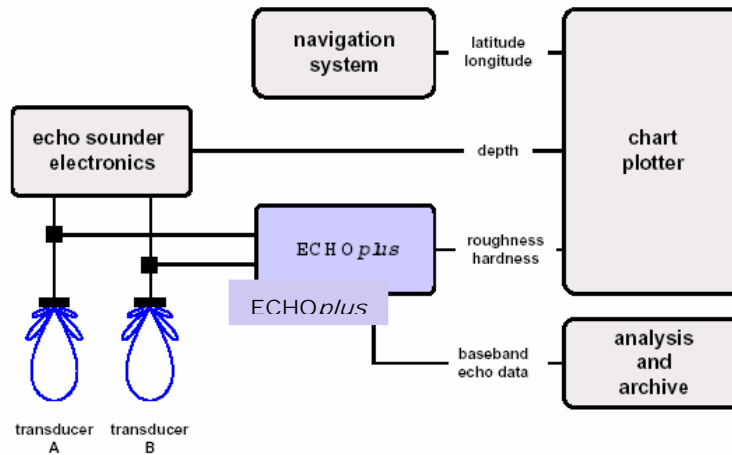
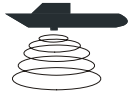
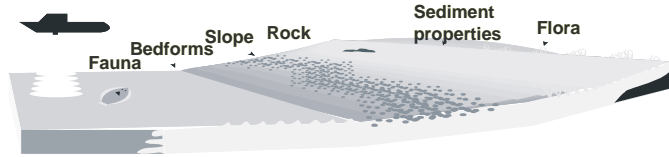

Figure 7: Overview of the Echoplus seabed classification system. Graphic Seatronics (2000).

The "acoustic diversity" of an area is determined by its actual diversity of bottom types

The "roughness" of the seafloor determines how strongly the echo of a signal sent from the surface will be distorted as it is reflected.
 The "roughness" of the seafloor is determined by its composition and the benthic community growing on it.



-the echo of an acoustic signal emitted from the survey vessel is influenced differently by rough or smooth bottom.

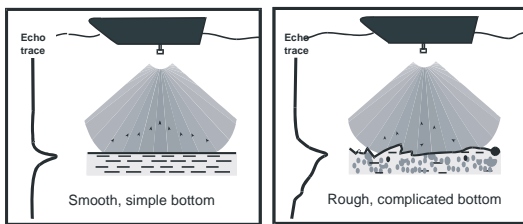

The actual returning echo looks like this:

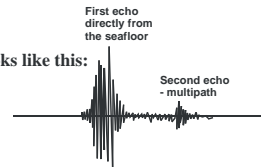

But the software digitizes it and changes it to the following shape:

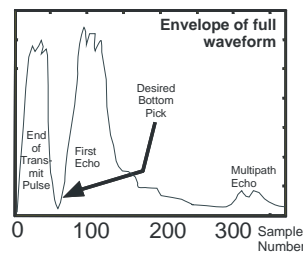

Digitization is extremely rapid, otherwise the quality of the wave-form envelope would be insufficient

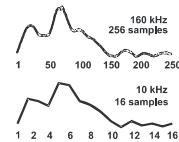

FFVs are then grouped into clusters of differing similarity by means of principal components analysis (PCA). While receiving guidance on the goodness of fit of the clusters, it is in the end the operator who decides how many splits are reasonable and can be interpreted.

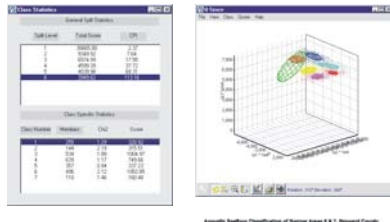

Since the FFVs are geocoded, the clusters also represent the spatial distribution of the seafloor-types which now can be mapped.

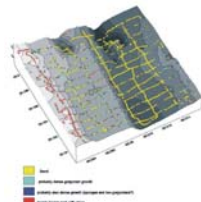

Series of 5 echoes get stacked (an image of the digitized shape above) and are then further processed by a number of algorithms that use a suite of 166 characters to describe each now define Full Feature Vector (FFV). FFVs are then
 (1) geocoded to a time-stamped GPS-string
 (2) Subjected to statistical analysis for grouping

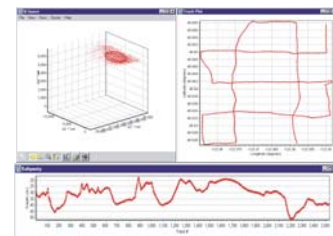

Figure 8: Overview of the QTC View acoustic ground-discrimination process. Modified from slides courtesy of Quester Tangent Corporation.

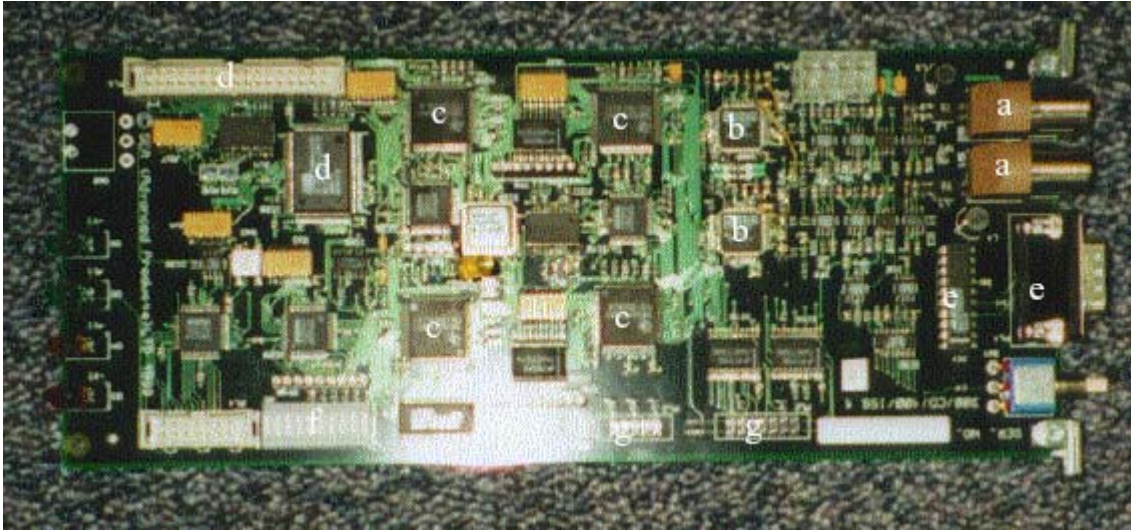

Figure 9: The Echoplus processor board. All data manipulations, until the output of E1 and E2 indices, are done internally, and the user has no way of interaction (Seatrionics 2000).

WORK FLOW

During project set-up, a project vessel was acquired (26ft. Thompson which was named the RV Surveyor). This vessel was chosen for its size and easy maneuverability. It provided enough shelter for operator and computer equipment.

Selection of signal frequency and transducer

Several options for the survey existed regarding hardware configuration that could significantly influence the results of the survey. These included choice of signal frequency. Original hardware configuration allowed a choice between 50 and 200 kHz. Frequencies are determined by the configuration of the head amplitude board, a unit that sits in between the signal generator and the acquisition board. The head amplitude board serves to time both the length of transmit and received pulses, as well as the time between transmit and received pulses. Timing is obtained via a stable oscillator, the frequency of which is optimized to signal frequency. Further hardware choices include the configuration of the transducer. Different frequencies frequently reflect different opening angles of the transducer. “Opening angle” refers to the angle of the sound cone spreading from the transducer towards the seafloor. The greater the opening angle, the greater the footprint (i.e. the area of seafloor insonified) and the smaller the accuracy. Thus, while the choice of signal frequency strongly influences the scattering properties of the signal (lower frequencies carry more energy than higher frequencies thus having the potential to enter more deeply into the substratum, potentially returning more subsurface rather than surface information) the choice of

transducer opening angle strongly influences survey resolution (the smaller the area sampled, the higher the ecological and survey “grain”).

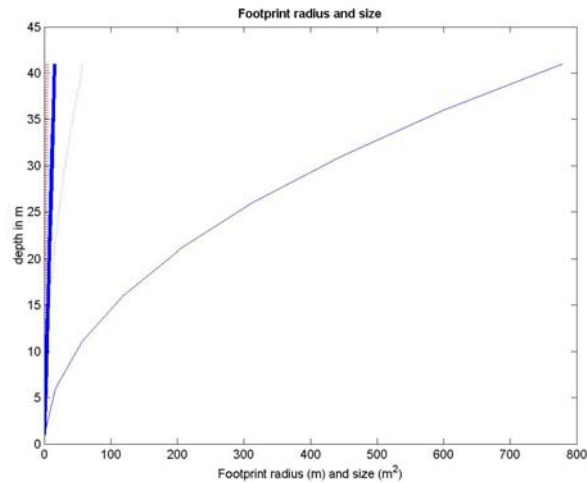

Figure 10: Outline of the differences in transducer properties. Red is the chosen transducer with 12° opening angle (200 kHz). Blue is the rejected transducer with 42° opening angle (50 kHz). Fat lines indicate radius, thin lines indicate area.

All survey hardware for the QTC View and Echoplus systems was configured for a 200 kHz transducer. This transducer (Suzuki TWW50-200-10L) had a 12° opening angle, which was preferable in greater depths to the 42° opening angle of the 50 kHz transducer because it effectively reduced the footprint to about one quarter in size (Figure 10). Furthermore, trials had proven that the 50 kHz signal carried significant surface and subsurface information but masked much of the surface scattering. Since the surface scatter was considered crucial for the present project, and experiments showed that surface scatter indeed detected algae and corals, it was decided to use the 200 kHz signal for theoretical (higher frequency acoustic signal carries less energy and thus scatters more easily) and practical reasons (footprint size at depth).

Illustrated below is a view of the “integrated survey system”, which includes a Suzuki depth-sounder, the complete Echoplus acquisition system, the complete QTC View system 5 acquisition system and the main computer for data storage (Figure 11). This system was custom-built and assembled at Nova Southeastern University Oceanographic Center (NSUOC) for the project.



Figure 11: The survey unit consisting of a Suzuki 2025 Echosounder, the various boards associated with the QTC View and Echoplus acoustic ground discrimination systems, and the data collection computer with flat screen. The entire unit is in a waterproof box.

During **Survey Planning**, all available bathymetry information from third-party sources was acquired and a complete bathymetric dataset of Broward County was assembled using Laser Airborne Depth Sounder (LADS) bathymetry, which served as guide for the selection of geographic cornerpoints and for the geomorphological interpretation of reefs.

The original statement of work detailed that survey lines should be oriented perpendicular to the dominant geomorphologic features (i.e. the reef lines) at a spacing of 50m. Several issues suggested changing the originally planned survey methodology:

Survey safety: Dominant direction of boat traffic along Broward, Dade and Palm Beach Counties is parallel to the shoreline. A slow survey boat moving perpendicular to the dominant direction of traffic was therefore a not much respected traffic hindrance. This was especially the case with skippers of bigger yachts who tended to engage in games of “chicken” with the survey boat (despite it flying a “limited maneuverability” flag to indicate it being on survey duty), which repeatedly created dangerous situations for the survey crew. Furthermore, the frequently encountered wakes by boats cutting across the survey vessel’s bow caused repeated physical damage to the survey computers. By following the direction of most traffic, the survey vessel was less of a hindrance and was less frequently singled out for excessive “waking”. This change increased the safety of the operation and integrity.

Data coherence: The size of the survey footprint (each individual insonified area of seafloor by each acoustic ping, which also corresponds to the ecological sample of the community included in this insonified area) is determined by geometric spreading (radius=tangent of half the acoustic opening angle times depth). Thus, the footprint at deeper localities is much bigger than at shallow localities (since the area of a circle is the square of the radius times pi, the insonified area increases to the second

power) and consequently includes a much larger ecological sample of reef fauna (or other substrate type) that scatters acoustic energy and thus determines the shapes of the received echoes. In order to achieve maximum data coherence, i.e. survey “tiles” with roughly comparable ecological characteristics, these were by necessity to be situated in comparable depths. Since the second and third reefs off Broward County occur within roughly the same depth zone (peaking between 15 and 20m, resulting in footprint sizes of roughly 2-3.5 square meters on a 200 kHz transducer), it was decided to include these two reefs within distinct survey tiles, and include all other shallower areas in other distinct survey tiles. Thus, the tiles could be evaluated separately or after fusion.

Data processing: A further argument for feature-parallel survey lines rests in the data-processing routine of QTC-View, one of the two employed survey systems. In order to avoid random acoustic noise, this system generates an “average waveform” of four consecutive echoes, which leads to a considerable stretching of the footprint. This large footprint considerably reduces any gains in accuracy that would be achieved by traveling perpendicular to the geomorphological features. It was therefore not considered worth the risk of the survey crew to maintain the coast-perpendicular survey schedule.

DATA COHERENCE AND SENSOR-DRIFT

Since acoustic sensors measure voltage returns, hardware configuration and installation are a real issue for data coherence. Anything that introduces noise, such as variable grounding of the acquisition units or creeping currents on the boats can cause measurable deviations of the signal. In order to evaluate whether data were indeed coherent between the thirty-four individual surveys that had to be collated, data were evaluated in several different ways to test for coherence.

In QTC View, individual surveys were identified that showed well defined patterns and from them, calibration files were built. Calibration files were only built from surveys which had acceptable data quality, assessed by standard QA performed in QTC Impact software. It was attempted to assure that the classes included in the calibration files were such that they could be encountered in all files, notwithstanding their exact geographical location (i.e. classes occurring on the ridges, reefs and sand; in general resulting in a four-class model). The accuracy and usefulness of these calibration files was then tested by plotting the classes against depth and geographic position using code written in Matlab 6.1. These calibration files were then used to perform supervised classification on the other survey files. By the quality of the performance of this supervised classification, sensor drift could be assessed. If no sensor drift had occurred, all classes defined by the calibration file should occur within each survey file and spatial patterns should be comparable in between surveys. If entire classes were missing or extremely sparsely populated after the supervised classification, and it was evident from the location of the chosen survey that the class really should occur in that file, it was assumed that signal properties of the entire survey were shifted and could thus not be directly compared. If this situation occurred, this was not considered to automatically invalidate the survey data. It was then attempted to individually evaluate these survey files. If a satisfactory

result was obtained (i.e. if the spatial distribution of classes in the individually classified file resembled those in the calibration file) the files were retained.

Evaluation of sensor drift in Echoplus followed similar guidelines. However, since Echoplus provides a string of continuous variables, no classification was necessary for evaluation of use of patterns. In the case of these surveys, data cleaning and manipulation had normalized all data to a range of 0-1. While data range was now intrinsically uniform, the normalization procedure masked the absolute values obtained during the surveys. Thus, the same numbers could be derived from high as well as low voltage returns and it was unclear whether the entire dataset could be fused for production of a single interpolation map of the entire county. If the same spatial pattern was obtained, sensor drift was considered to be minimal. If changes between the spatial patterns were observed between the fused and unfused files, it was considered that sensor drift had occurred and files were evaluated separately.

BIOLOGICAL INVESTIGATIONS TO SUPPORT ACOUSTIC CLASSIFICATIONS

Study Area

Site selection was determined using three areas of focus (north, central and south corridors) within Broward County. The north corridor was situated off and just north of Hillsborough Inlet, the central corridor was situated off Hugh-Taylor-Birch State Park, and the southern corridor was situated off Hollywood (Figure 12). Within each corridor, sites were selected along each markedly three-dimensional structure (referred to as either a “ridge” or a “reef”) running perpendicular to shore. These included the shallow ridge complex (near-shore environment typically <6m), inner reef (6-10m), and middle reef (10-20m). Along each “reef”, data was collected on the edge (inshore), crest and slope (offshore).

A total of 53 sites were chosen strategically based on information derived from reconnaissance dives, available biological information, high resolution bathymetry, acoustic habitat classification data, and existing data in the form of biological monitoring reports and bathymetric maps from Broward County Department of Planning and Environmental Protection (DPEP).

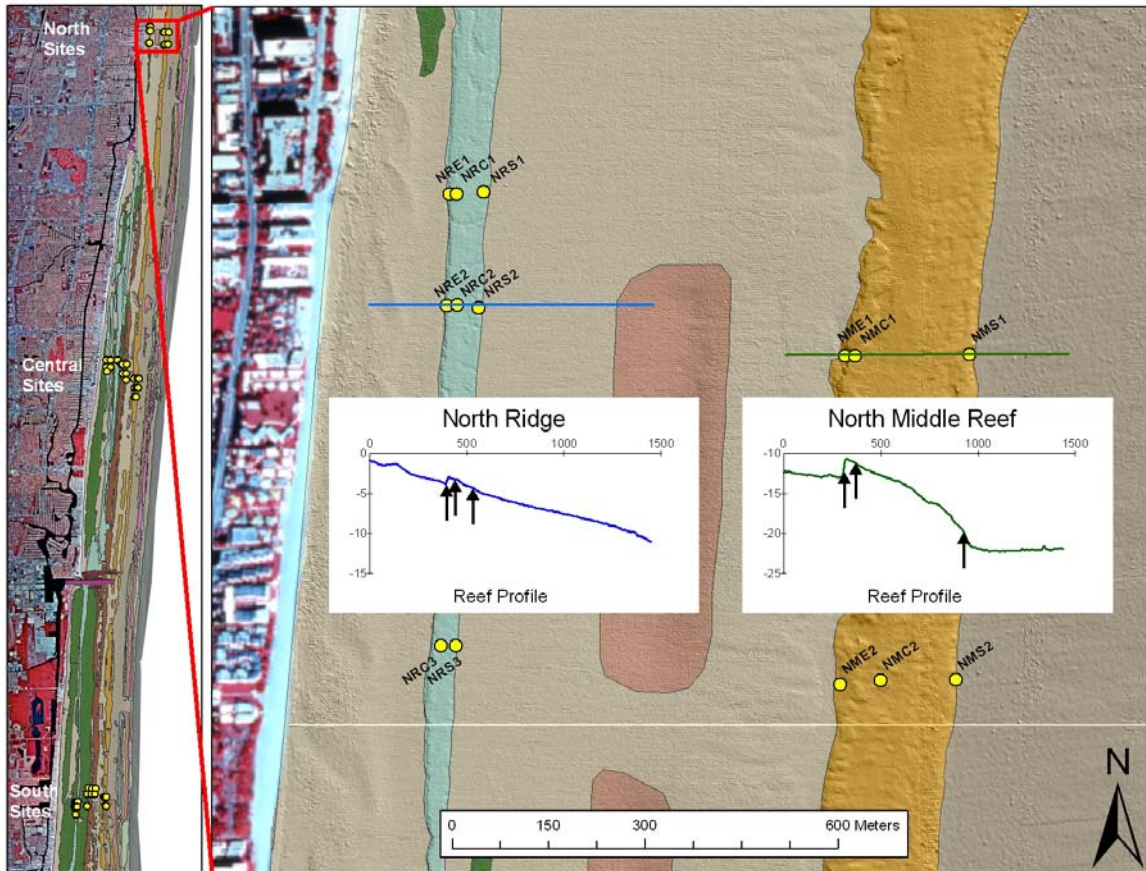

Figure 12: Illustration of the North biological assessment sites. The sites were chosen by location within the county, between reefs, and within reefs. The blue and green lines represent the area evaluated for each reef profile.

Ecological Sampling

Data was collected by taking a series of digital underwater 0.5 x 0.75m images utilizing a rigid framer (Figure 13). Two replicate photo quadrats, consisting of 32 photos each, were taken at each of the 53 sites. This amounts to an area of 4x4 meters.

As additional dataset, six 50-m point-intercept recording transects were obtained on the inner, middle and outer reefs from the northern and southern corridors.



Figure 13: Rigid 0.5 x 0.75 underwater camera framer.

PHOTO ANALYSIS

Color, brightness and contrast were adjusted using Adobe Photoshop software as needed to identify benthic taxa. Benthic assemblages were determined for each photo according to the following five categories:

Substrate:	Sand, Pavement, Rubble, Large Debris
Algae:	Turf, Fleshy Macroalgae, Calcareous Macroalgae
Coral:	Scleractinian (Massive), Scleractinian (Encrusting), Alcyonaceans (Massive-Tall), Alcyonaceans (Massive-Short), Alcyonaceans (Encrusting)
Sponge:	Porifera (Massive), Porifera (Short/Encrusting)
Other:	Other (Zoanthids, Tunicates, Hydroids)

Surface area estimates were made to the nearest 1% with the aid of paper squares representing 1%, 2%, 5% and 10% of the computer screen view. The benthic assemblages were averaged for each site based on 1-6 quadrats (32-192 photos).

RESULTS

JUSTIFICATION OF SURVEY PLANNING AND LINE ORIENTATION

We compared the overlap between two tiles that were obtained with both survey orientations – one perpendicular, one parallel to major geomorphological features. This exercise was repeated four times. Figure 14 shows an area south of Port Everglades that was surveyed with both coast-perpendicular survey

lines and coast-parallel survey-lines. As the classification of QTC View data shows, both surveys identify reef classes and sand classes in the same areas. This is shown best on the third reef (the right-hand, mainly red and blue data), where data from the two surveys strongly agree. Some acceptable level of disagreement is seen on the second reef, which could be addressed with more detailed post-processing.

These results suggest that coast-parallel orientation of the surveys provided similar results to the coast-perpendicular orientation. This indicated overall stability of the classifications. It also indicated that four of these existing shore-perpendicular surveys could be retained and used in the new dataset, rather than be re-surveyed. The majority of surveys were conducted in a coast parallel fashion.

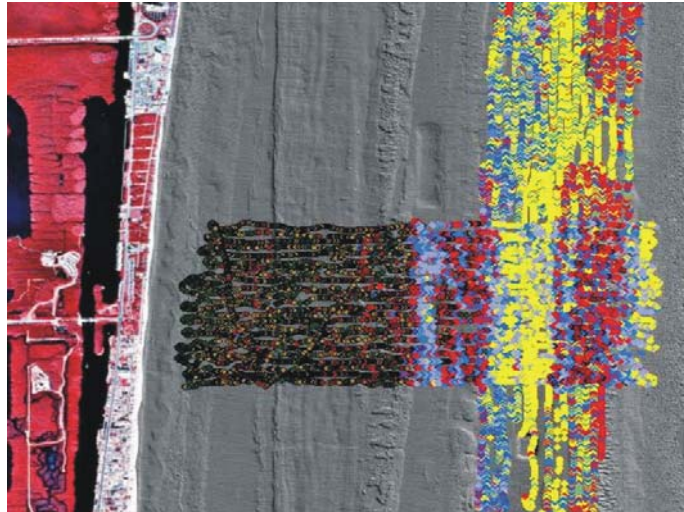

Figure 14: Overlap and correspondence of QTC View classified data obtained by shore-perpendicular and shore-parallel surveys. Good agreement was found. This suggests that data from both surveys are directly comparable, and that no decrease in data-quality can be expected by changing the direction of surveys

SURVEY TRACKLINES

During the surveys, the entire marine area of Broward County from the 6m depth contour to the 35m depth contour, as stipulated by the contract, was surveyed at a line spacing of 50m. A total of 44 survey files were produced. Each survey file includes a complete survey tile. The entire Echoplus dataset consisted of 1,270,061 individual datapoints. All line files are shown in Figure 1. Figure 15 shows again the arrangement of survey lines parallel to shore (with the exception of the original four surveys that were taken perpendicular to the coast).

SURVEY RESULTS IN QTC VIEW

We selected two calibration areas in which data from the inshore and offshore survey days were so merged that a roughly rectangular area stretching from the inshore survey-limit to the offshore survey-limit

was obtained. This incorporated typically about 2x1 km in area and also incorporated all known habitats. Next, these data were cleaned and processed to a uniform quality standard. Data were plotted along the first three principal components, which resulted in the southern calibration area an oblong data cluster that suggested maximum variability along the first principal component analysis axis, PC1 (Figure 16). Therefore, the cluster was repeatedly split along this axis. Clustering statistics suggested that four clusters would be the optimal number of splits, which is illustrated by the CPI rapidly increasing (Figure 16). The depth distribution of the obtained classes clearly indicated that depth-contamination did not affect the clustering process, since all classes occurred over all depths. It was, however, also clear that different classes had clear depth-preference. Of the four classes, only three classes showed clear distributional preferences, while one was sparse and distributed evenly over the entire depth. One class was clearly preferentially distributed in the deeper areas (outer reef and beyond), one class was clearly preferentially distributed on the middle reef, and one reef, despite also occurring on the middle and outer reefs clearly was most common on the nearshore ridges and hardgrounds (Figure 16).

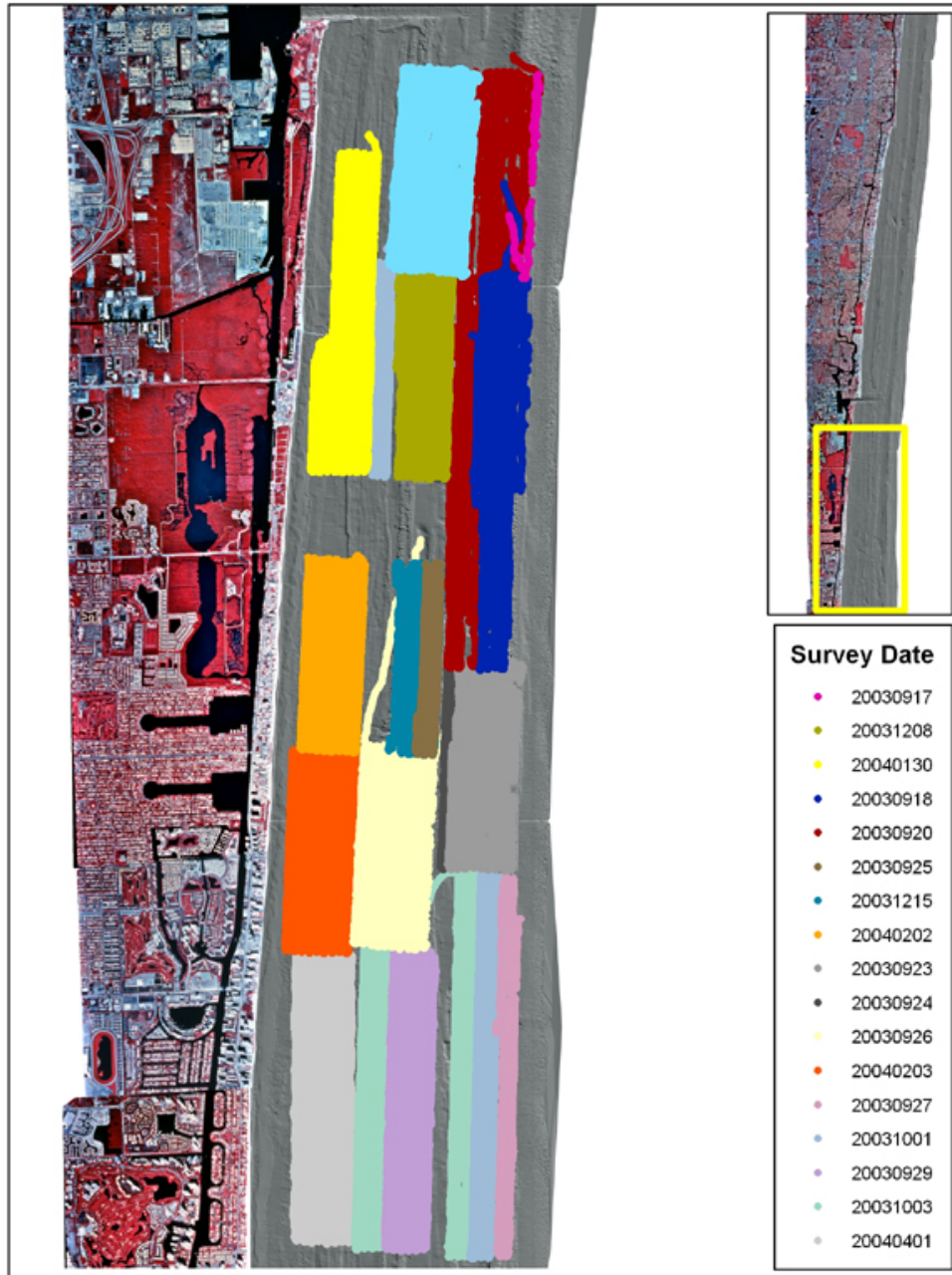

Figure 15: An example of the arrangement of surveys. All surveys, except those performed at the very beginning of the project, were arranged in a shore-parallel fashion.

In the northern calibration area, the data showed a similar oblong trend along the PC1 axis when plotted along the first three principal components. Also in this case, splitting to four clusters was reflected favorably by an increase in the CPI. The Total Score statistic, however, showed an inflexion after three clusters, suggesting that three clusters could be the optimal number. In order to stay comparable to the data analysis in the southern calibration area, we proceeded to split to a total of four clusters. Also in this case, all classes occurred in all depths, suggesting that depth contamination had not affected the data. Only three

of the four classes showed a clearly favored distribution in depth and position, one class was virtually ubiquitous. Two classes clearly favored the outer and middle reef and showed more or less marked discontinuities in between. Another class appeared to favor the areas in between the reefs, since it occurred at lower density, or not at all, on either of the reefs or ridges.

This result was interpreted as evidence that indeed the four classes encoded the same substrata in the north and in the south of Broward County and showed essentially a split between reefs and inter-reef areas, as well as in the characteristics of the reefs. In the north, the difference in between reefs (inner-middle-outer) was not clear; all three reefs were encoded by the same signal class. In the south and in the middle of Broward County, it was clear that the ridges and inner reef were characterized by different acoustic classes.

The same analyses were performed using a k-means clustering routine instead of the Bayesian algorithm provided by the QTC software. Results of the k-means clustering were not interpretable and were therefore not further used.

This suggested the following overall interpretation of acoustic returns:

- (1) one class was distributed ubiquitously and was thus considered useless,
- (2) one class was preferentially distributed on the shallower reefs (ridges, inner reef)
- (3) one class was preferentially distributed on the deeper reefs
- (4) one class was preferentially found in the flatter areas (i.e. outside the reefs)

The above outline is a generalization. Individual signals attributed to either class also occurred outside the above outlined areas, however, the bulk of signals followed this scheme and thus led credence to the hypothesis that the method could indeed differentiate different seafloor types. Therefore, it was decided that data from all surveys should be split to four classes. These four classes were to be plotted and three of these were to be selected for interpretation of substratum scattering characteristics. One class was expected to be ubiquitous and thus, for mapping purposes, nonsensical. This class was considered to comprise mixed signals composed of several substratum types, caused by the stacking of five consecutive footprints during signal processing.

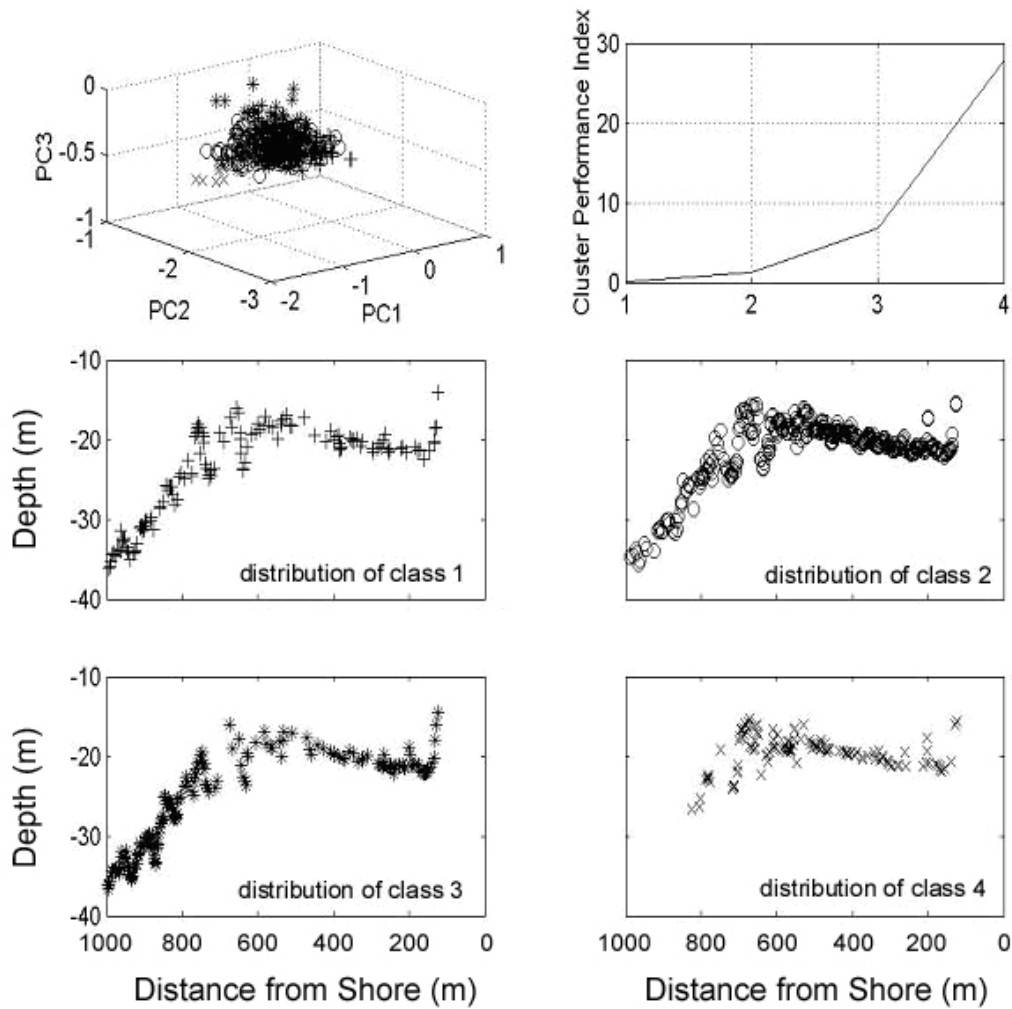

Figure 16: Ordination of all datapoints along the first three principal components. Data within the point cloud are coded according to class. The cluster performance index is a measure indicating whether a splitting decision was correct, which is indicated by an increase in value. The top right graph indicates that the splitting decisions to four clusters were correct. Four plots underneath show the depth distribution of the four classes in central Broward County. The class coded with crosses shows the most uniform distribution, and thus has the least diagnostic value. All other classes show preferential distribution in a more or less well-defined depth zone.

In the next step, it was attempted to increase accuracy of discrimination by eliminating data points with low cluster confidence and probability values. A series of values were used as threshold, but it proved efficient to remove all data with <95% confidence and <70% probability. In the case of the southern calibration area, this removed 44.4% of data for the confidence criterion and 89.3% of the data for the probability criterion.

In the case of the northern calibration area, it removed 75.5% and 95.7% respectively. While in the case of the southern calibration area the comparison of trackplots of cleaned versus uncleaned data showed that indeed a better spatial differentiation of clusters was achieved with stronger data cleaning, this was not

the case in the northern survey area, where applying the same criteria led to the disappearance of entire clusters. It was therefore decided to not eliminate data points according to set levels of confidence and probability criteria (Figure 17).

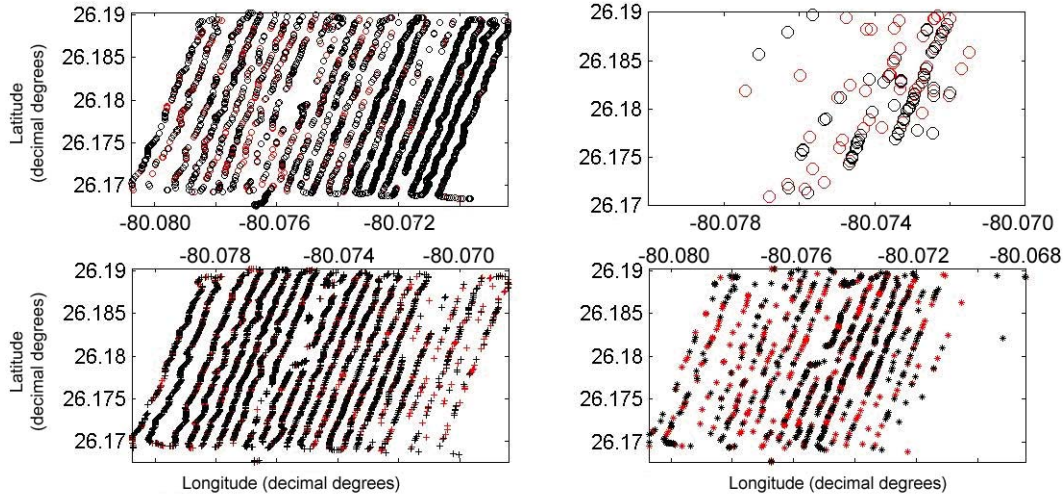

Figure 17: Track plots indicating the data losses incurred (red datapoints flagged for deletion) if supervised classification using a calibration dataset is performed and data are then cleaned to remove all points with <90% cluster confidence and <70% cluster probability. It was decided that data loss was unacceptably high and that data cleaning after supervised classification was unrealistic.

SURVEY RESULTS IN ECHOPLUS

A total of 39 survey tiles were used. The digital number return encoded different categories than the QTC survey. In QTC, some clear differences were found between the reefs and the shallow and deep area, however the within spatial patterns were not very clear. In Echoplus, a very clear differentiation between low-scatter areas on reefs and sand and high-scatter areas was found. The Echoplus surveys allowed a clear delineation of the reefs and rubble areas as high-scatter areas. Also within the reefs, areas of relatively higher and lower scatter were detected.

Data distribution of the E1 parameter was normal, while that of the E2 parameter was strongly non-normal (Figure 18). It is not clear why the E2 parameter was so strongly skewed to small values. From survey geometry and the relative distribution of hardgrounds versus softgrounds in Broward County, a more normal distribution could have been expected. Due to this result, the E1 parameter was favored in further analyses over the E2 parameter.

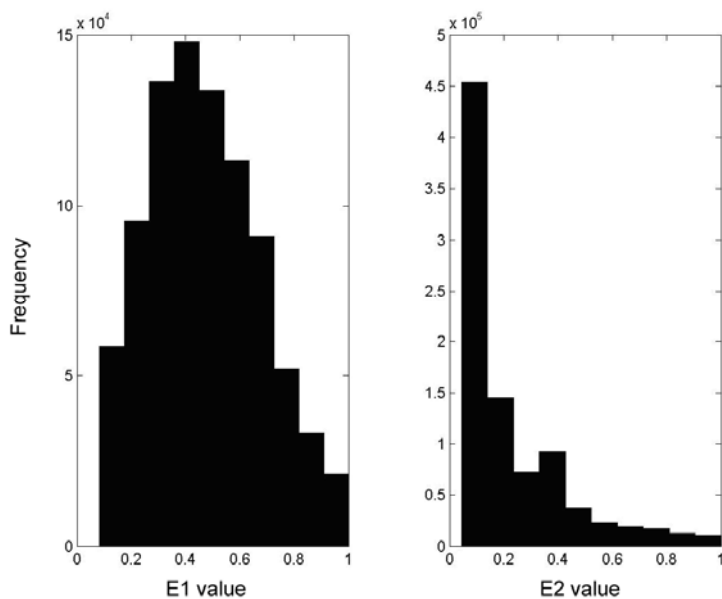

Figure 18: Distribution of E1 (left) and E2 (right) parameters obtained from 883447 acoustic signals that passed several levels of quality control and were used for mapping. Data were grouped into 10 bins. Larger numbers of bins did not significantly alter the distribution pattern.

Plotting E1 against E2 showed results that could be expected from the frequency distribution. Large cluster of signals with low E2 (hardness) and variable E1 (roughness) could be interpreted as a whole suite of scattering environments in largely unconsolidated (soft) sediments. A cluster with higher E2 but yet very valuable E1 values could be interpreted as a suite of scattering environments in hardgrounds (i.e. reefs, Figure 19).

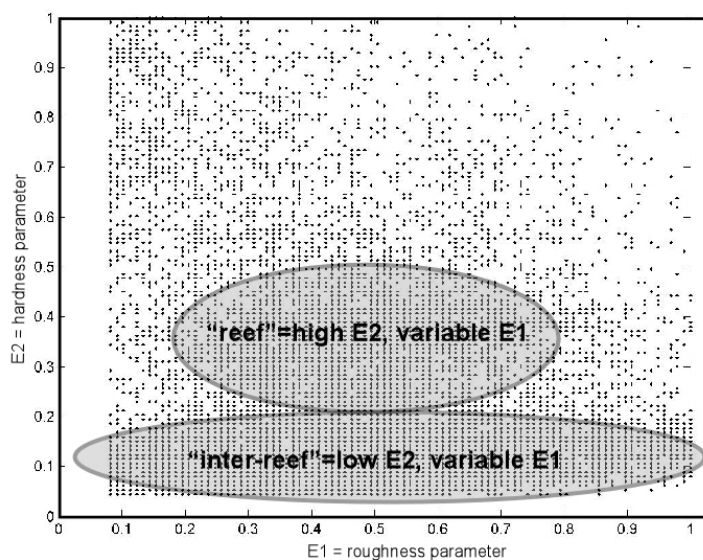

Figure 19: Distribution of E1 versus E2 over the entire survey area. The hypothetical classes “reef” and “inter-reef” are indicated. Only 1% of data could be printed for graphical reasons, therefore the denser clusters are not very well visible.

EVALUATION FOR INTERNAL CONSISTENCY OF DATA

Since the surveys were conducted over a period of 12 months and in different weather and sea states, the question arose how consistent data were among different surveys. Since the acoustic seafloor discrimination is based on the detection of very small voltage changes, it is conceivable that small differences in the hardware, wiring, or even the climate (e.g. electricity in the air due to nearby thunderstorms), could influence survey results. Also, slow changes in the physical behavior of the transducer known as sensor drift could be induced by slow corrosion of the cables in the salty air. This would affect, for example, the efficiency of delivery of “clean” (i.e. relatively pure sine wave) electricity.

Internal consistency of data refers to results within individual surveys, but also to results between surveys. To test for this, the QTC View and Echoplus results from individual surveys were plotted and checked for the consistency of the spatial pattern provided by these surveys and underlying LADS bathymetry (Figure 20). If breaks in the sequence of assigned classes coincided with apparent breaks in underlying bathymetry (i.e. geomorphology), it was concluded that the classes really showed a useful pattern. This was the case for most individual surveys. Where no useful pattern was detected in comparison with the underlying bathymetry, the dataset was assumed faulty and not further used.

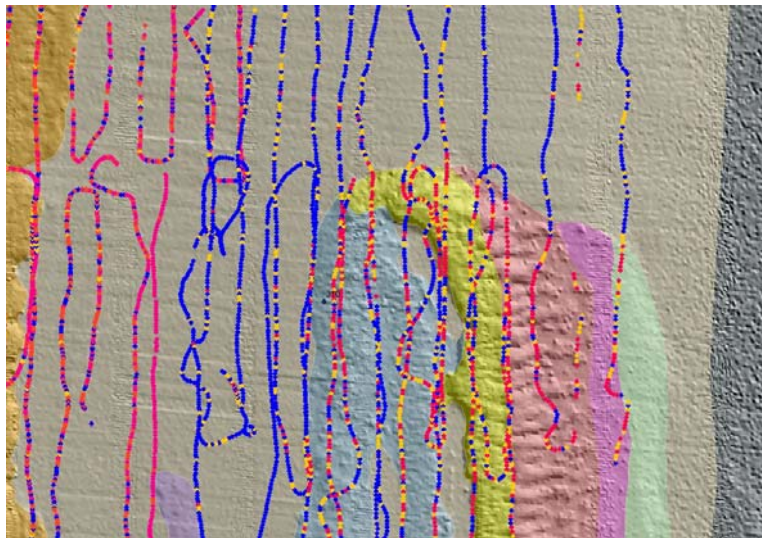

Figure 20: Part of two independent QTC View surveys. Class numbers (1,2,3,4) are assigned to the same colors (red, yellow, magenta, blue). The blue class in the right-hand survey corresponds well with sandy areas (flat=low scatter) while the red and orange classes correspond to the higher scatter of areas of reef. A fourth class, represented with magenta, was very rare and did not seem to correspond to any particular habitat type. This survey was considered internally consistent. The class assignment in the left-hand survey is not consistent with that of the right-hand survey. A different class was assigned in the sandy area. Thus the data from the two surveys cannot be fused into a single dataset for resampling and interpolation.

Next the consistency of class assignments (or level of E1, E2 values) between surveys had to be evaluated. This equates to the question: “Does class X in two adjacent surveys encode the same substratum

type?” In almost all instances this was not the case, since class assignment in QTC Impact is strictly along the first three principal components of the processed data, which thus retain little of the original signal characteristics that could be directly correlated to a substratum type. While the clusters made sense, the cluster assignment (i.e. the code given to each other) was essentially arbitrary and could therefore rarely be directly compared between surveys.

Since class assignment was not consistent with regards to the same bottom types between the surveys, an attempt was made to use supervised classification. For the evaluation of the QTC data, two calibration areas were used (see section “survey results in QTC View”), one in northern and one in central Broward County. In order to evaluate whether the classes in both calibrations encoded equivalent substratum types, calibration files were built for each area and then applied for a supervised classification of the reciprocal dataset (i.e. the signal variables of the second dataset were forcibly grouped by using the values defining clusters in the first dataset). Results were comparable, although not identical. In both cases, three of the four classes proved useful. In the southern calibration area, the same preferred depth-distribution of classes was found as when split without calibration file – one class mainly distributed on the outer reef, one class mainly on the middle reef, and one class mainly on the inner reef and ridges. In the northern calibration area, one class was found preferentially on the outer reef, middle reef and the ridges and two classes showed clear absences where the first class was very frequent and clearly favored the areas in between the ridges.

Due to this finding, the QTC View data were fused into three large survey blocks (south, middle, and north) and an attempt was made to employ supervised classification on these fused data with one single calibration file. The surveys within these blocks were taken within a sufficiently narrow timeframe to at least allow for the assumption of data coherence. However, the classes obtained from the supervised classification process were not as easily interpretable and spatial patterns were far less clear than when each survey was classified separately. Thus, supervised classification of larger, fused datasets was rejected in favor of class-assignment in each individual class, even though the problem remained that the assignment of class number was not consistent between surveys. However, the individual surveys were internally consistent and could thus be used to aid in the interpretation of other, ancillary data (Figure 21).

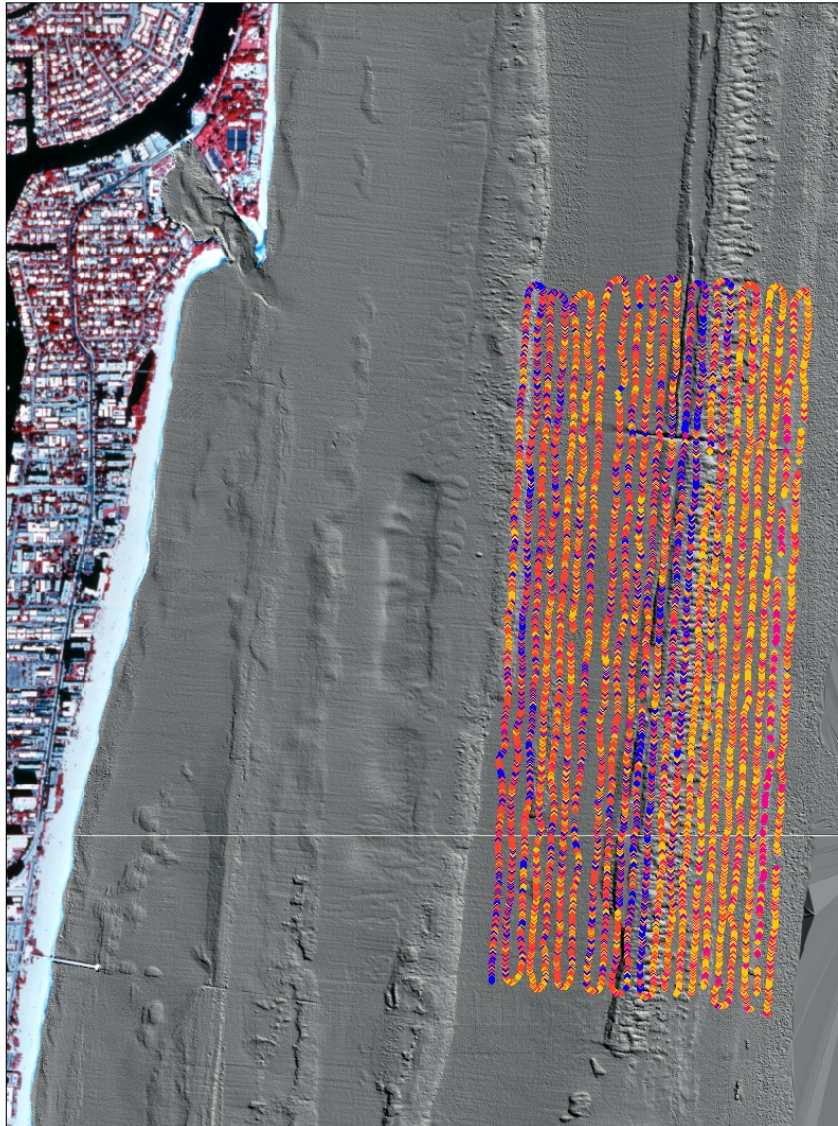

Figure 21: Overview of a classified QTC View dataset, as it was used for the development of the Broward County habitat map. A blue class is seen occurring primarily on the deep reef and, to a lesser extent, on the middle reef and in the flat sandy area in between the reefs. This can be interpreted as a class encoding high scatter by a high gorgonian assemblage that occurs on the deep reef, in some parts of the middle reef (the frequency of blue dots is lower on the middle reef, suggesting less dense fauna) and in some areas between the reefs-presumably rubble field. Rubble itself generates high scatter, but is additionally usually settled by a comparable faunal community to the reefal areas. Thus, blue-coded regions aid to differentiate between sand and rubble in areas of uniform bathymetry. This would not be possible from the LADS bathymetry alone.

DATA GRIDDING AND INTERPOLATION

Since the surveys were performed using single-beam sonar, no spatially continuous cover of bottom type information was obtained. Instead, individual survey lines were obtained with a maximum of 50m (which, in reality, was usually less, since the footprints have a radius of several meters) of unknown

substratum in between. Due to the arrangement of survey lines and geomorphological features, the dataset were strongly anisotropic. It is possible to re-sample the irregular data to a regular pattern and then interpolate classes to the empty areas in between the survey lines.

Interpolation for the categorical QTC View data was attempted with a nearest-neighbor search based on a Delauney triangulation (Davis 2002) (Figure 22). Results were satisfactory for many surveys, however, consistency among the interpolations of neighboring surveys remained problematic. It was therefore decided not to use interpolated maps in the present survey, but rather, to use the individual data points of the classified bottom signal to aid in interpretation of geomorphologic features.

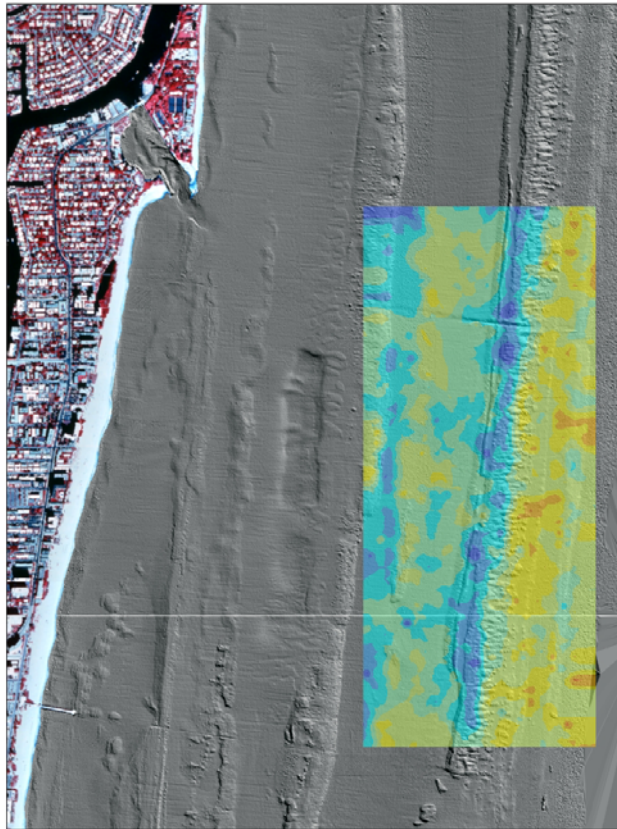

Figure 22: Example of interpolated QTC View data. It is clear from the image that edge-effects affect the interpolation. Thus, it will be desirable to interpolate on larger, fused datasets. Further work on assuring between-survey data consistency is still required, thus no interpolated maps were used for the production of maps in the present report.

Echoplus data were also gridded and resampled for each survey independently, since these data suffered from similar between-survey inconsistency as the QTC View data. Echoplus data, being continuous variables, were interpolated using geo-statistical evaluation (kriging) (Figure 23). Individual surveys and survey blocks were then fused after individual (or per block) evaluation. Results were satisfactory for individual surveys and blocks of few fused adjacent surveys, but not for larger areas. Since more work is required to assure internal data consistency of the larger, fused, datasets, a decision was made

not to use Echoplus interpolated maps, but rather to use only the point-database to aid in interpretation of geomorphologic features.

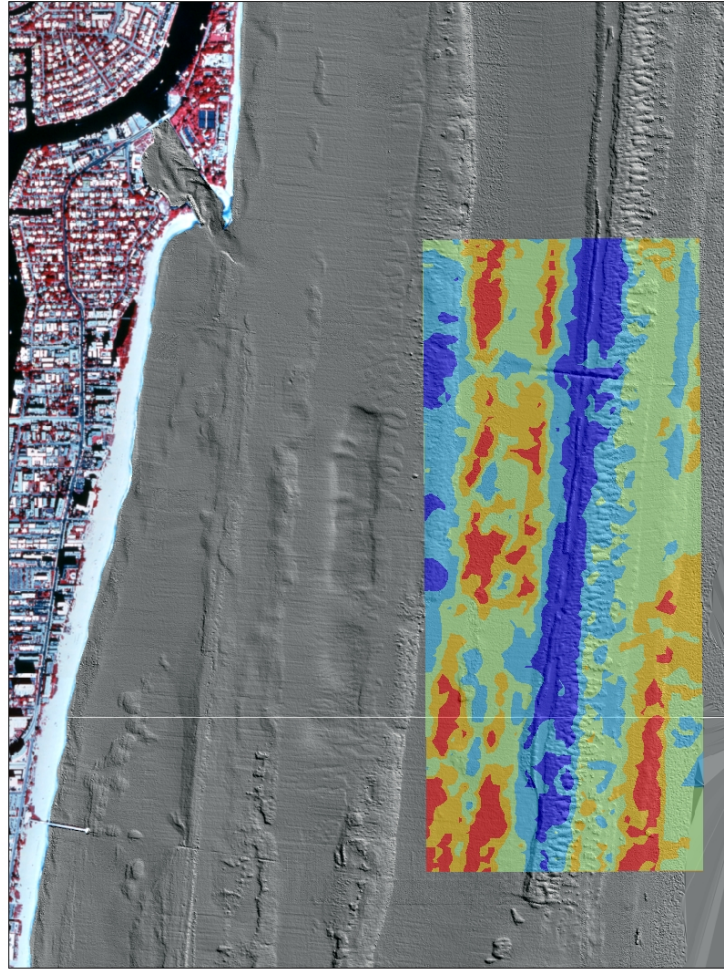

Figure 23: Example of interpolated Echoplus data. The same area is evaluated as in Fig. 21. The overall pattern is comparable. The Echoplus dataset shows less edge-effects affecting the interpolation. Also for these data, further work on assuring between-survey data consistency is still required, thus no interpolated maps were used for the production of maps in the present report.

INTEGRATION OF DATA TYPES

For the production of final maps, several data products were integrated:

- 1) LADS bathymetry of the entire Broward County
- 2) Aerial photography of Broward County coastline
- 3) Selected data from QTC View survey
- 4) Echoplus survey

- 5) Subbottom chirp-sonar information
- 5) Visual groundtruthing information
- 6) Ecological data from previous surveys

The LADS bathymetry was used for visual, expert-driven, assignment of reef classes. This was aided by subbottom chirp lines, which aided in the classification process between hardground, reef or softground (Figure 24). In many areas, flat hardgrounds and sandy areas cannot be told apart by bathymetry alone. See Walker et al. (*in review*) for further description of the subbottom profile survey data.

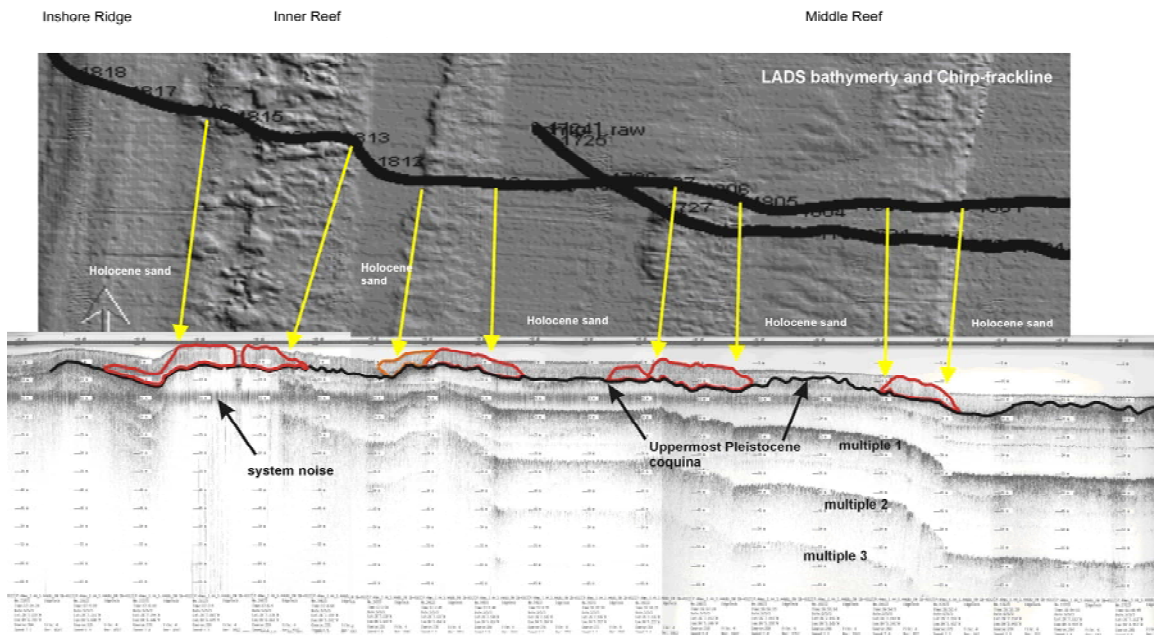

Figure 24: Subbottom information was used in the decision process between hardground and sand. While the QTC View and Echoplus data generally allowed the differentiation of flat hardground from flat sand, the information obtained from the chirp profiles aided in training the QTC View and Echoplus interpretations.

Depth constraints of acoustic ground discrimination precluded its use in shallow water (<6m contour) therefore ancillary data were used to map the inshore reefs. Aerial photography and the LADS bathymetry were the primary products employed to discriminate the shallow areas. Several preexisting GIS products facilitated the western edge of the inshore hardbottom and several shallow worm reefs. These products were the outcome of a beach renourishment study by Broward County’s Department of Planning and Environmental Protection in 2000 to map the nearshore hardbottom.

The within-reef patterning of the QTC View survey was rejected for the present mapping product since the produced patterns are still in need of further interpretation. The between-reef pattern of the QTC surveys was confirmed by in-hand ecological data and was thus retained. The QTC View data were thus

essential to justify the between-reef differences of scatter types that could be related to different heights of the fauna, which again correlated to different community types.

The Echoplus survey provided additional information to the bathymetry, since it showed well-defined roughness classes that aided in the identification of areas of increased roughness caused by benthic fauna or flora in areas of uniform bathymetry. This aided in the detection of isolated vegetation patches and in the differentiation of flat hardground from flat sand.

BIOLOGICAL INFORMATION RELEVANT TO MAPPING CLASSES

Several sets of biological data were used. Presented below are the coverage data for the major “acoustically active” assemblages in the area between the nearshore ridges and the middle reef. The taxa that most strongly determined acoustic scatter were “Alcyonaceans (Massive-Tall)”, “Alcyonaceans (Short/Encrusting)”, and Porifera (Figure 25). It is evident from the pie charts (Figures 26 to 28) and tables (Tables 1 to 3) below that the relative contribution of alcyonaceans and sponges tended to increase on the middle reef. Also, the percentage of bare substratum (grey in the figures) generally decreased from the ridges to the middle reef. Thus the observation of a distinct acoustic class on the shallow consolidated hardgrounds and ridges versus another distinct class on the middle reef, indeed reflects a realistic and quantifiable faunal scenario.



Figure 25: Examples of the major “acoustically active” assemblages- Alcyonaceans-Massive-Tall (top left), “Alcyonaceans-Short/Encrusting (top right)”, and Porifera (bottom).

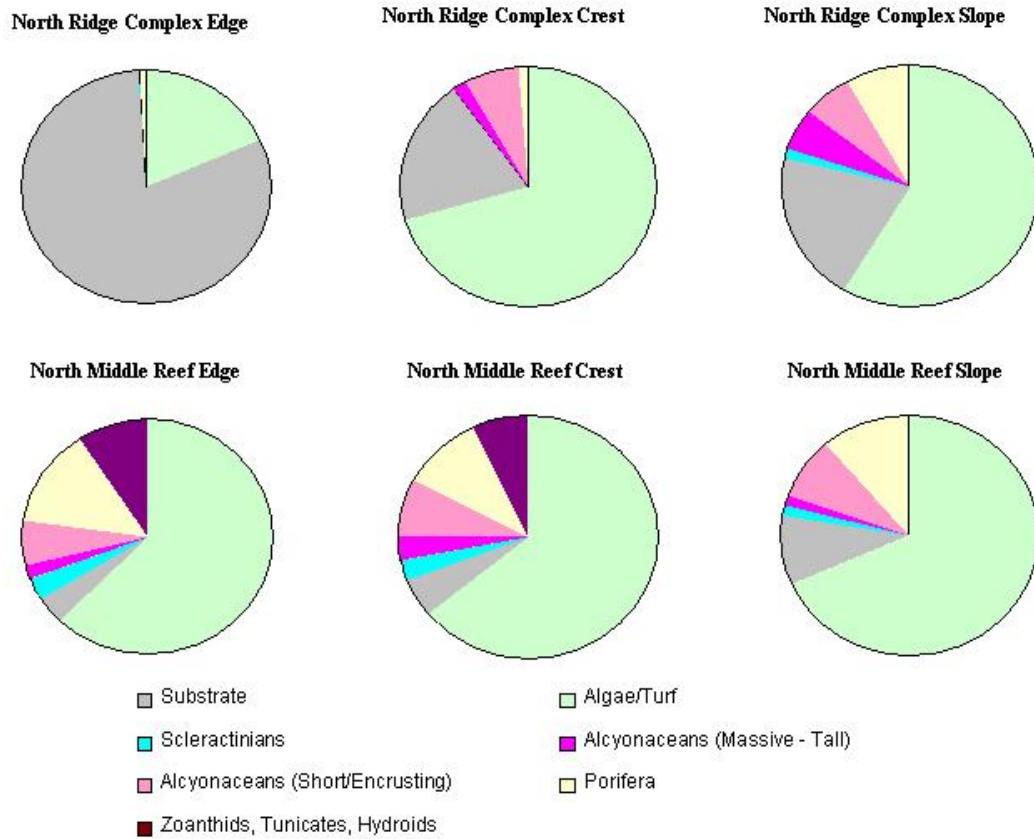

Figure 26: Comparison of space cover from photo-squares on the nearshore ridges and middle reef in the North corridor.

	Algae	Substrate	Scleractinians	Alcyonaceans Massive/Tall	Alcyonaceans Short/Encrust	Porifera	Other
North Corridor							
North Ridge Edge	18%	80%	0%	0%	0%	1%	0%
North Ridge Crest	70%	20%	0%	2%	7%	1%	0%
North Ridge Slope	58%	20%	1%	6%	6%	8%	0%
North Middle Edge	62%	4%	3%	2%	7%	14%	9%
North Middle Crest	64%	5%	2%	4%	7%	10%	7%
North Middle Slope	68%	9%	1%	1%	8%	11%	0%

Table 1: Statistics corresponding to Figure 26.

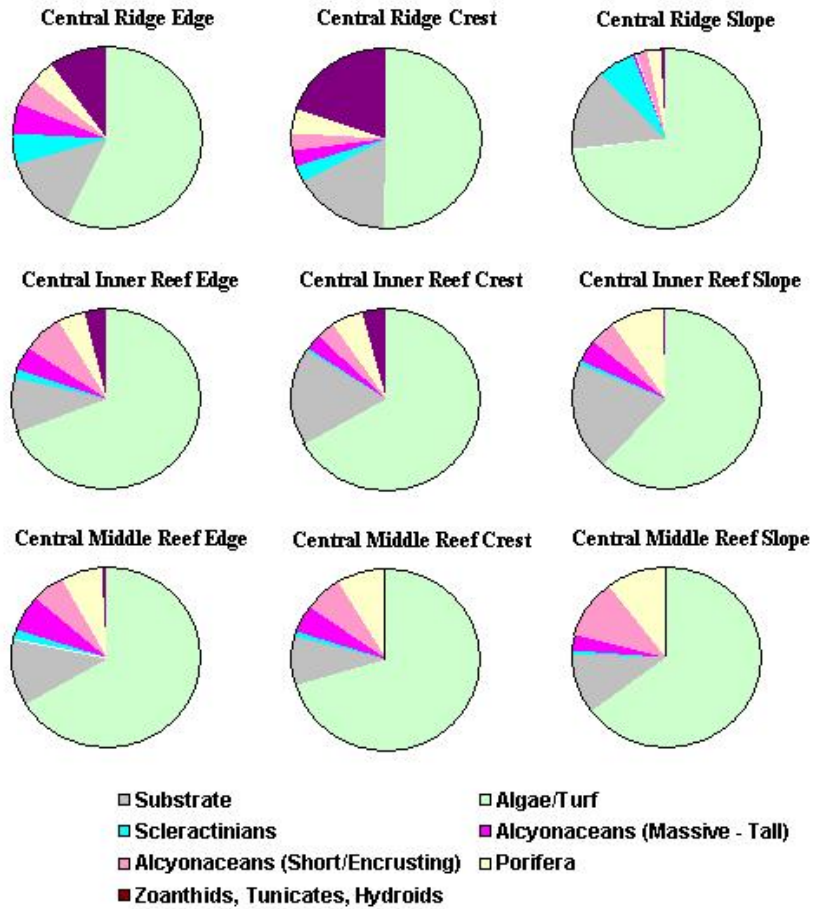

Figure 27: Comparison of space cover from photo-squares on the nearshore ridges and middle reef in the Central corridor.

Central Corridor	Algae	Substrate	Scleractinians	Alcyonaceans Massive/Tall	Alcyonaceans Short/Encrust	Porifera	Other
Central Ridge Edge	57%	13%	5%	5%	5%	4%	10%
Central Ridge Crest	51%	16%	3%	3%	3%	4%	20%
Central Ridge Slope	73%	15%	7%	0%	2%	2%	1%
Central Inner Edge	69%	10%	1%	5%	7%	5%	4%
Central Inner Crest	67%	17%	1%	2%	3%	6%	4%
Central Inner Slope	62%	20%	1%	4%	4%	9%	0%
Central Middle Edge	66%	12%	2%	7%	6%	7%	1%
Central Middle Crest	70%	9%	1%	5%	6%	8%	0%
Central Middle Slope	64%	11%	1%	3%	11%	10%	0%

Table 2: Statistics corresponding to Figure 27.

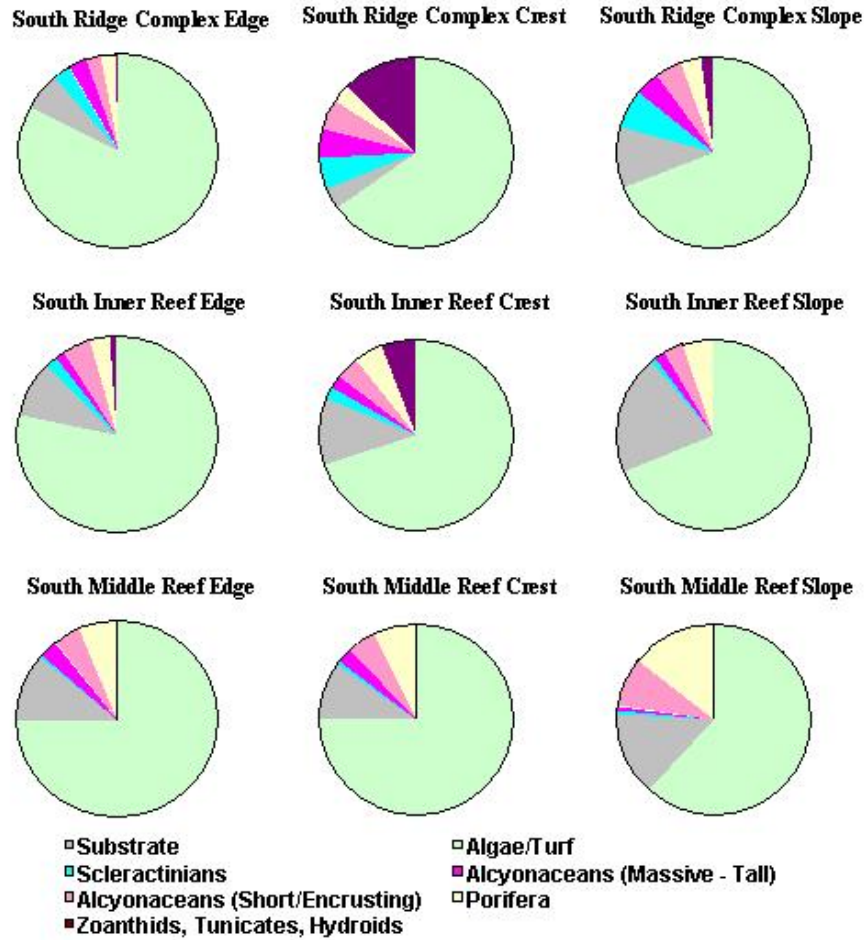

Figure 28: Comparison of space cover from photo-squares on the nearshore ridges and middle reef in the South corridor.

	Algae	Substrate	Scleractinians	Alcyonaceans Massive/Tall	Alcyonaceans Short/Encrust	Porifera	Other
South Corridor							
South Ridge Edge	83%	6%	3%	3%	3%	2%	1%
South Ridge Crest	65%	3%	5%	5%	5%	3%	13%
South Ridge Slope	69%	10%	7%	5%	4%	3%	2%
South Inner Edge	78%	9%	1%	2%	5%	3%	1%
South Inner Crest	70%	11%	2%	2%	4%	5%	6%
South Inner Slope	69%	20%	1%	2%	4%	5%	0%
South Middle Edge	75%	11%	0%	3%	5%	6%	0%
South Middle Crest	75%	10%	1%	3%	5%	7%	0%
South Middle Slope	61%	15%	0%	1%	8%	15%	0%

Table 3: Statistics corresponding to Figure 28.

Data taken with 50m point-intercept transects supported this differentiation. In four evaluated “test corridors”, it was shown that the benthic communities encountered on all three major reef lines (Inner versus Middle versus Outer) differed (Figures 29 and 30). The faunal components primarily responsible for these differences were the gorgonians and sponges – the component of the benthos which is also responsible for the clearest backscatter component in the acoustic signal. Thus it was decided that the observed trend of up to three distinct acoustic classes that correlated in general with the three major reef lines, was indeed realistic. In the mapping product, each reef line was therefore coded with a unique color identifier.

The supporting biological data also suggested, just as the acoustic data, that within-reef differentiation of communities was observable. However, since both the biological and the acoustic data require more detailed work for a final analysis of within-reef differentiation of the benthic community, only first rudimentary results are presented.

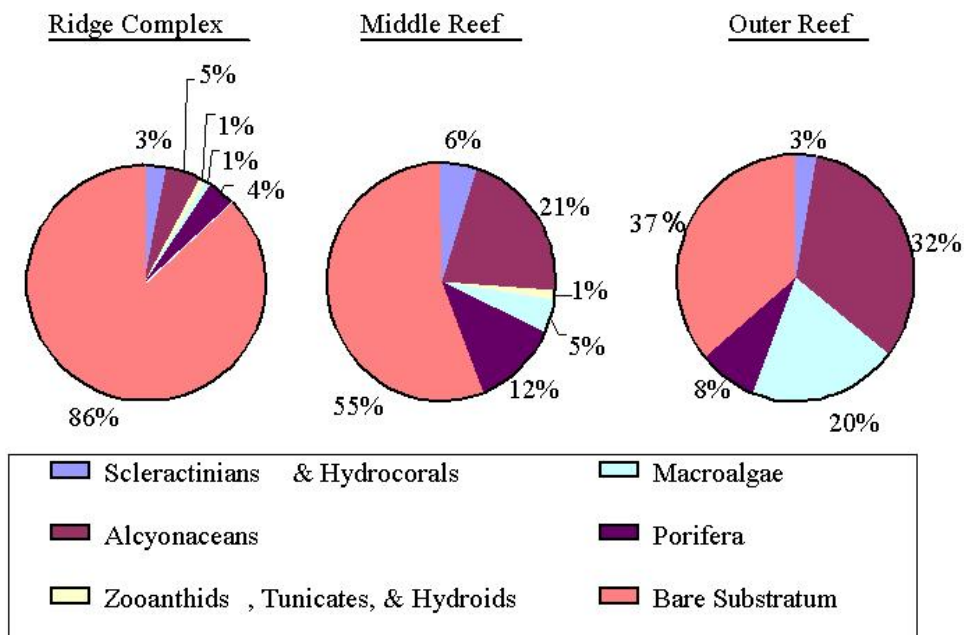

Figure 29: Comparison of space cover from 50-m line intercept transects near Hillsboro inlet.

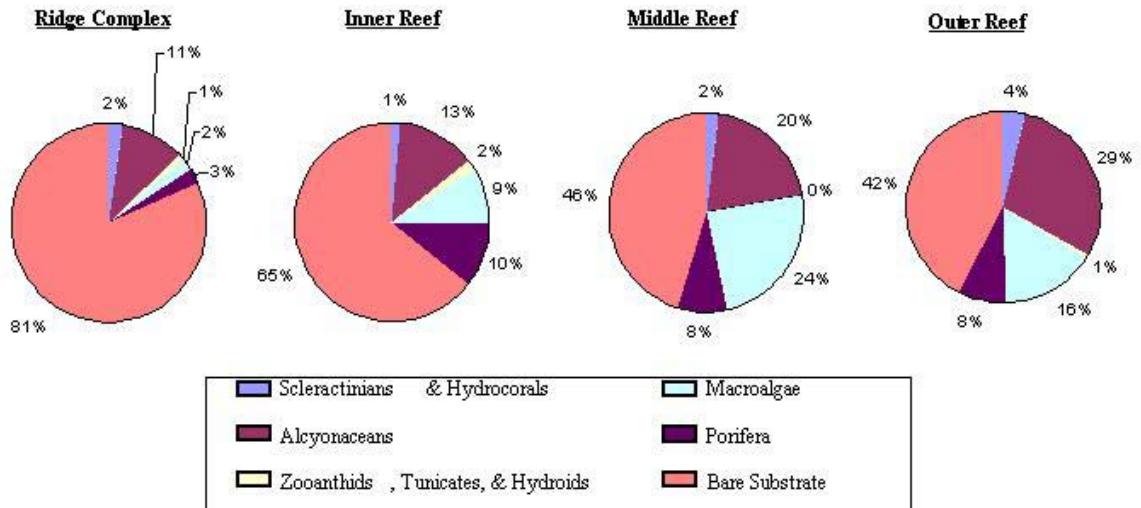

Figure 30: Comparison of space cover from 50-m line intercept transects in central Broward County.

The results from the 50m line-intercept recording transects also clearly supported the conjecture that the biological properties of the benthic community were indeed the source of the observed different acoustic classes on individual reef lines. We see these results as confirmation that the transducer frequency was indeed correctly chosen and that the acoustic classes in QTC View and differences in E1 and E2 in Echoplus are resultant primarily of differential backscatter in environments of unequally high fauna. Thus the subsurface reverberation component of the signal was largely eliminated and the signal was not sensitive to substratum type but primarily to the scattering properties of the seafloor. This notion is supported by the fact that clear breaks in acoustic classes tended to coincide with breaks in benthic community type. Some substratum dependence of acoustic classes remains, since areas of bare rippled sand or bare rubble could be demonstrated to have similar scattering properties as some dense benthos community types. This is not surprising, since any structure that can produce significant scatter would produce comparable signal properties, notwithstanding the scatterer being a biological or substratum category. This confusion of mapped classes remains and is one of the reasons why more work is needed to produce clear and scientifically defensible within-reef patterns of habitat differentiation.

FINAL MAPPING CATEGORIES

For the production of the final maps, a bottom-up approach was taken (Hewitt et al., 2004). The high resolution LADS bathymetry was used to map reef geomorphology; acoustic data (QTC and Echoplus) were used to aid in defining the geomorphologic features into habitat types; and a waterproof drop video camera from a boat was used as groundtruthing to confirm substrate type. The entire area to be mapped was roughly 110 square-kilometers. The shallow inshore seafloor from the 0m to -6m contour was mapped using a combination of assimilated data types including aerial photography and high-resolution bathymetry and the deeper seafloor habitats, from the -6m to the -35m contour, were mapped using mostly high-resolution bathymetry and acoustic ground discrimination. The result produced a seamless GIS benthic habitat classification of the entire nearshore reef system in Broward County.

The final map polygons conformed to the NOAA hierarchical classification scheme used in Puerto Rico and the U.S. Virgin Islands NOAA Technical Memorandum NOS NCCOS CCMA 152 (Kendall et al., 2001), with some modification. All data were mapped in ArcGIS 9 and polygons were drawn at a scale of 1:6000 with a one acre minimum mapping unit (MMU). The most notable modification was in the mapping of different zones. The Puerto Rico mapping effort classified the polygons into nine reef zones according to the feature's relationship along the shore (i.e. lagoon, back reef, fore reef, bank/shelf, etc.). These categories were useful because the NOAA effort mapped everything from land and intertidal out to the bank/shelf escarpment. However, many of these mapped zones do not apply in South Florida. The absence of an emergent reef in South Florida precludes mapping zones such as lagoon, back reef, and reef crest. Also our effort was confined to depths between 0m and 35m, which excluded the land. The intertidal zone was not distinguished in this project. Thus, all features mapped in this project reside within the Bank/Shelf, Fore Reef, or Bank/Shelf Escarpment zones.

Benthic habitats were also made compatible to the NOAA Puerto Rico mapping effort with slight modification. The submerged vegetation habitat was omitted due to the lack of detectable seagrass and macroalgae. This is not to say these habitats do not exist in South Florida, but that our mapping methods did not detect such habitat.

QTC View results were used to provide additional classes. The differentiation of linear reef into three acoustic classes corresponded with ecological data. This enabled us to split the NOAA class "Linear Reef" into the following three subclasses:

- Inner linear reef (corresponding to the shallow ridges and inner reef)
- Middle linear reef (corresponding to the medium depth middle reef)
- Outer linear reef (corresponding to the deep outer reef)

Other changes to the scheme include a depth component added to sand, colonized pavement, and ridge habitats. Ridge, sand borrow area, and wormrock categories were added.

The classification scheme for the South Florida mapping effort is as follows:

Coral Reef and Hardbottom

Coral Reef and Colonized Hardbottom

- Linear Reef
 - Outer*
 - Middle*
 - Inner*
- Spur and Groove
- Individual Patch Reef
- Aggregated Patch Reef
- Scattered Coral/Rock in Unconsolidated Sediment
- Colonized Pavement
 - Deep*
 - Shallow*
- Ridge*
 - Deep*
 - Shallow*

Unconsolidated Sediments:

- Sand
 - Deep*
 - Shallow*

Other Delineations:

- Artificial
- Wormrock*
- Inlet Channel*
- Sand Borrow Areas*

DESCRIPTION OF MAPPED REEF HABITATS:

All definitions are NOAA definitions as described in Technical Memorandum NOS NCCOS CCMA 152 (Kendall et al 2001) and on their web site (<http://biogeo.nos.noaa.gov/products/benthic/html/descrip.htm>) unless otherwise noted by an asterisk (*).

Coral Reef and Hardbottom: Hardened substrate of unspecified relief formed by the deposition of calcium carbonate by reef building corals and other organisms (relict or ongoing) or existing as exposed bedrock.

Coral Reef and Colonized Hardbottom: Substrates formed by the deposition of calcium carbonate by reef building corals and other organisms. Habitats within this category have some colonization by live coral.

Linear Reef: Linear coral formations that are oriented parallel to shore or the shelf edge. These features follow the contours of the shore/shelf edge. This category is used for such commonly used terms as fore reef, fringing reef, and shelf edge reef.

Linear Reef-Outer*: This category included essentially only the reef crest of the outer reef.

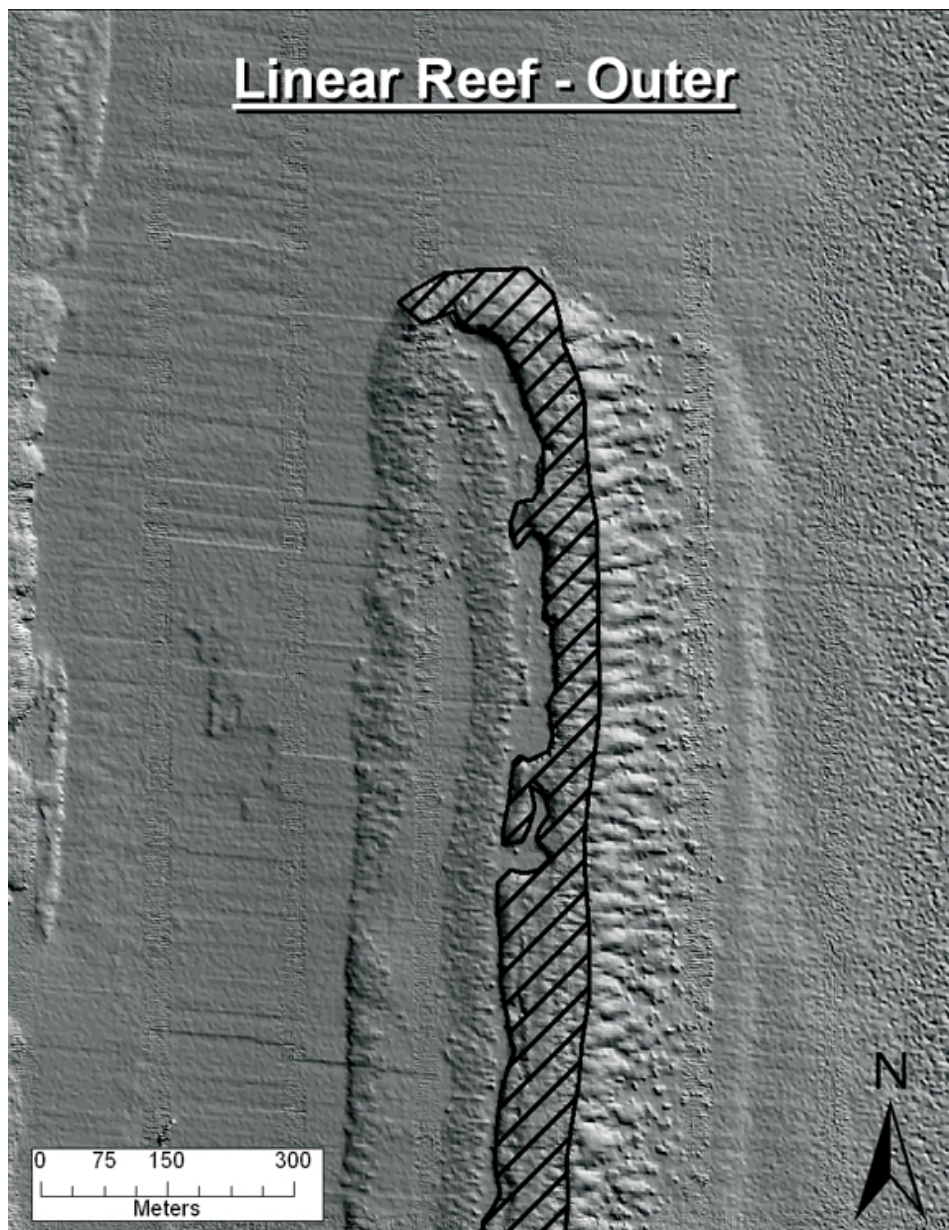

Figure 31

Linear Reef-Middle*: Since the middle reef exhibited much less clear morphological differentiation than the outer reef, it was not practical to subdivide it into several units. It is therefore encompassed in one single category, “linear reef”. This category is given a unique color identifier since the acoustic roughness measures suggest a largely distinct community structure from hardgrounds, shallow reef and outer reef.

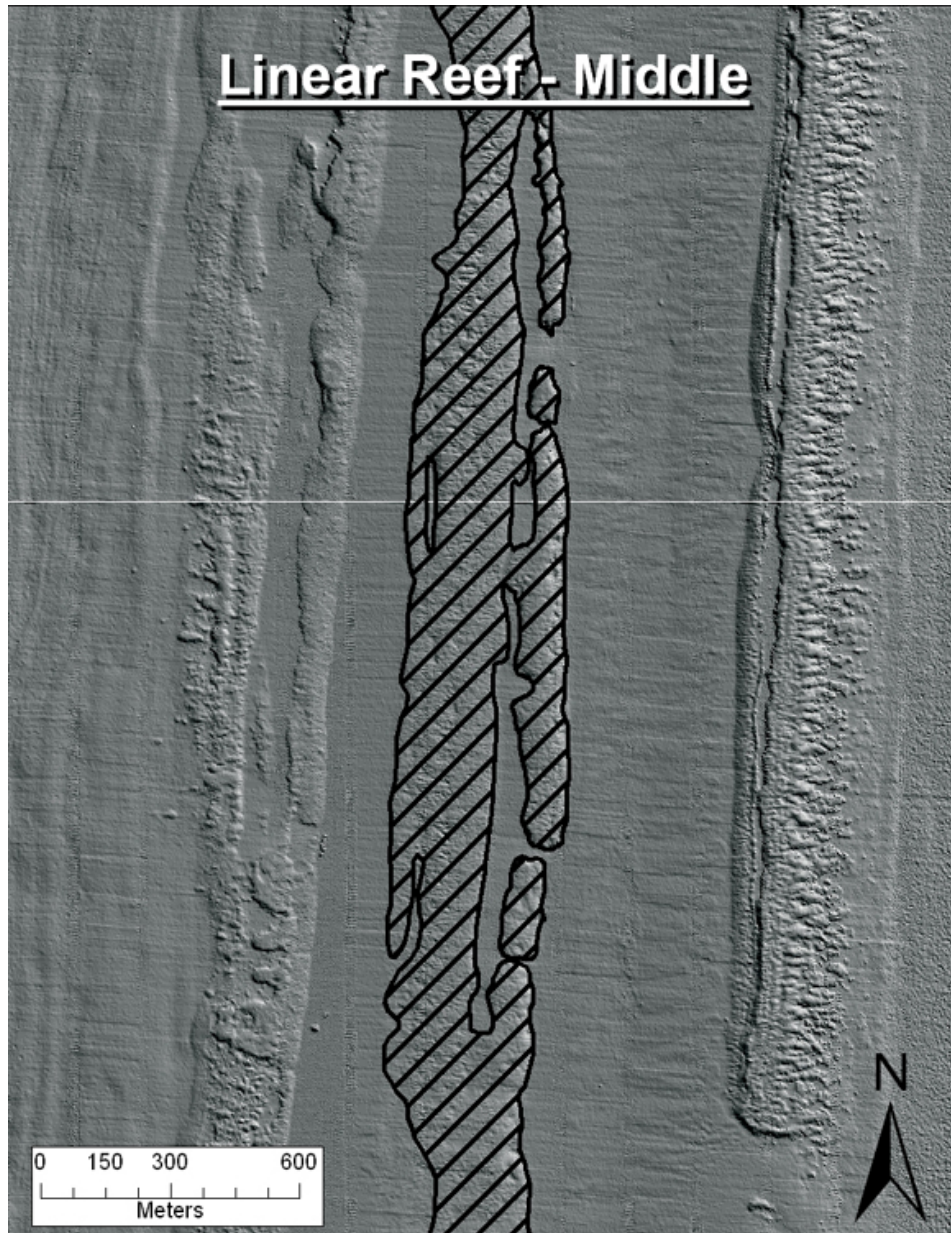

Figure 32

Linear Reef-Inner*: Similar to the middle reef, also the inner reef is best described as linear reef since it also lacks a clearly defined zonation with a backreef and groove-and-spur system. It has a unique color identifier since acoustic and biological data indicate that it harbors a distinct benthic community from the middle and outer reefs.

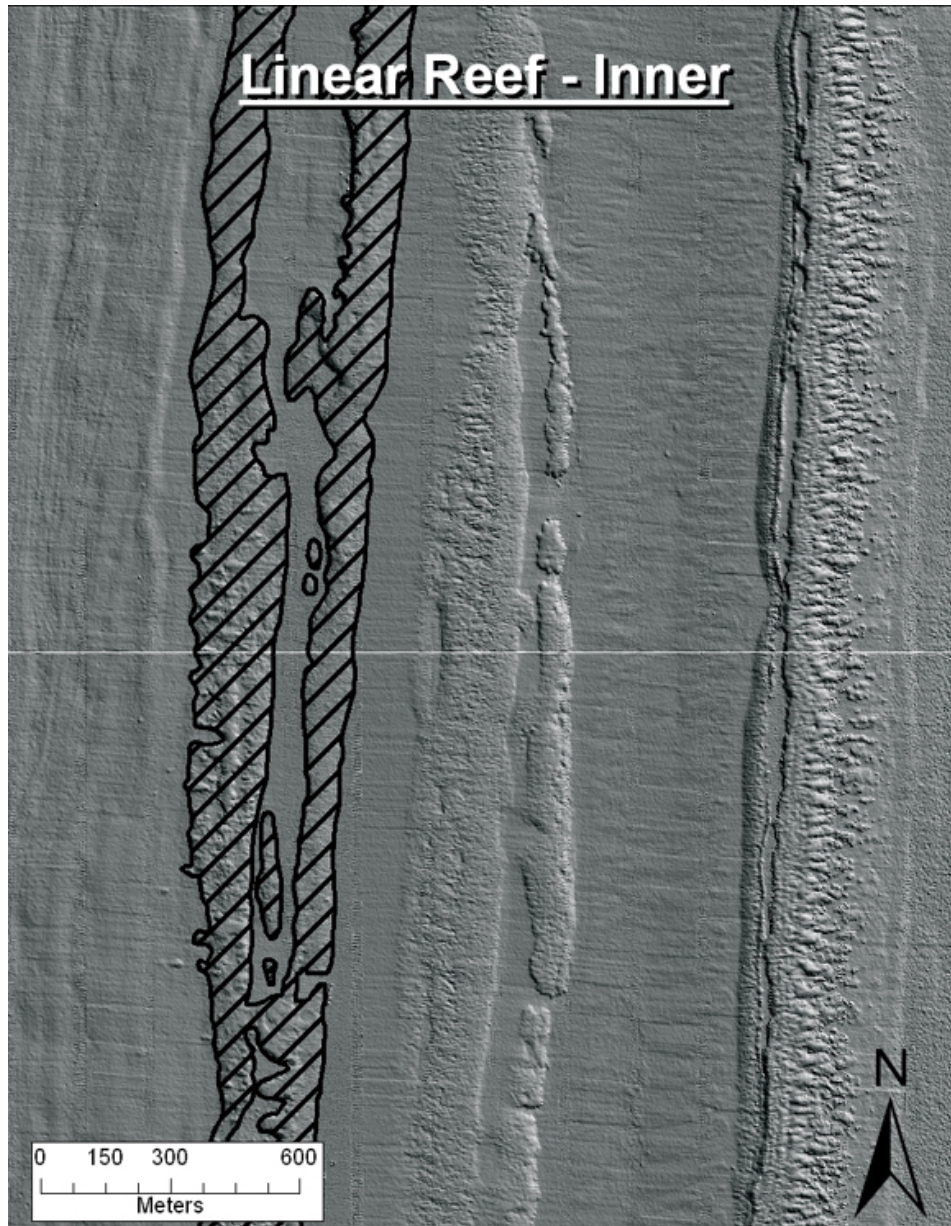

Figure 33

Spur and Groove: Habitat having alternating sand and coral formations that are oriented perpendicular to the shore or bank/shelf escarpment. The coral formations (spurs) of this feature typically have a high vertical relief compared to pavement with sand channels and are separated from each other by 1-5 meters of sand or bare hardbottom (grooves), although the height and width of these elements may vary considerably. This habitat type typically occurs in the fore reef or bank/shelf escarpment zone.

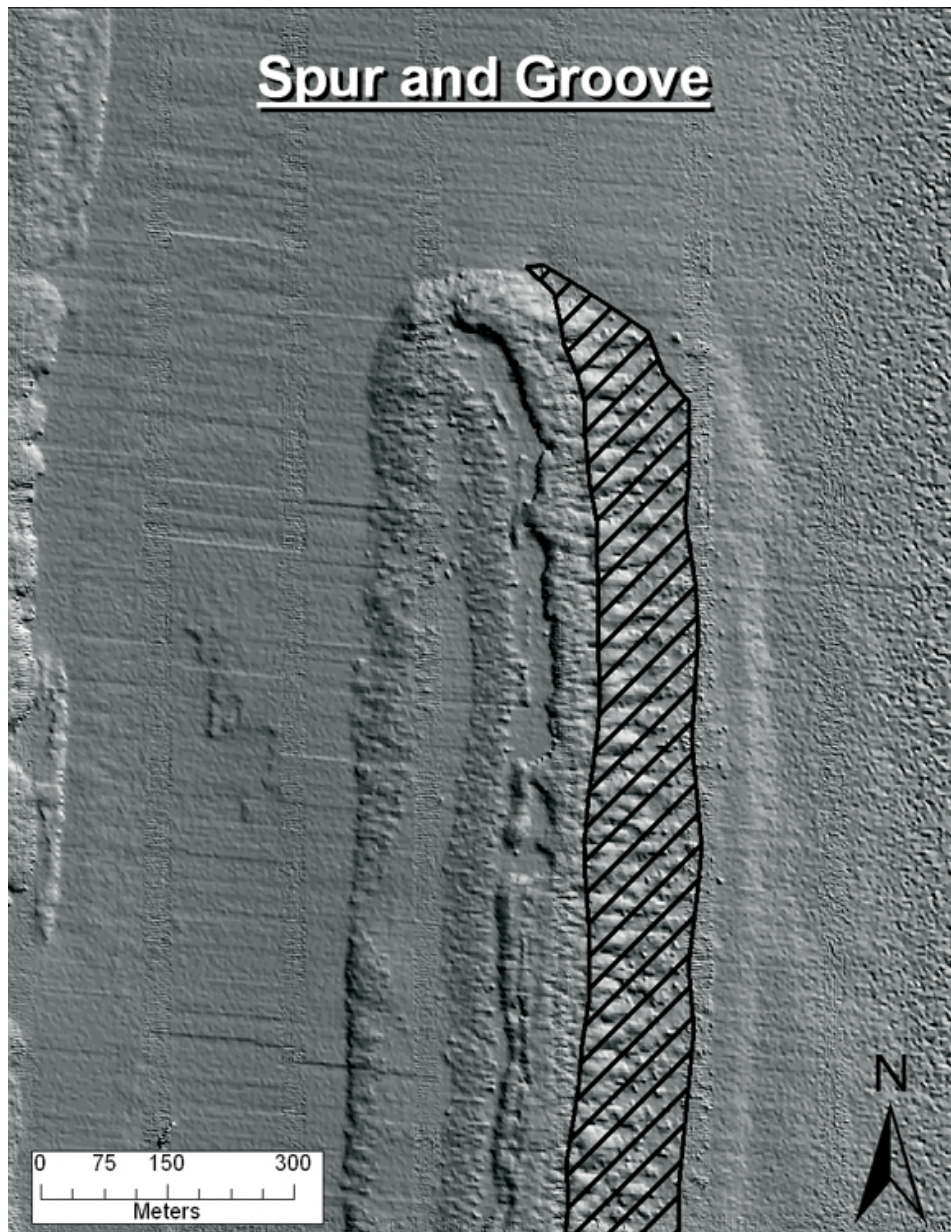

Figure 34

Patch Reef: Coral formations that are isolated from other coral reef formations by sand, seagrass, or other habitats and that have no organized structural axis relative to the contours of the shore or shelf edge. A surrounding halo of sand is often a distinguishing feature of this habitat type when it occurs adjacent to submerged vegetation.

Individual Patch Reef: Distinctive single patch reefs that are equal to or larger than the minimum mapping unit (MMU). When patch reefs occur in submerged vegetation and a halo is present, the halo is included with the patch reef polygon.

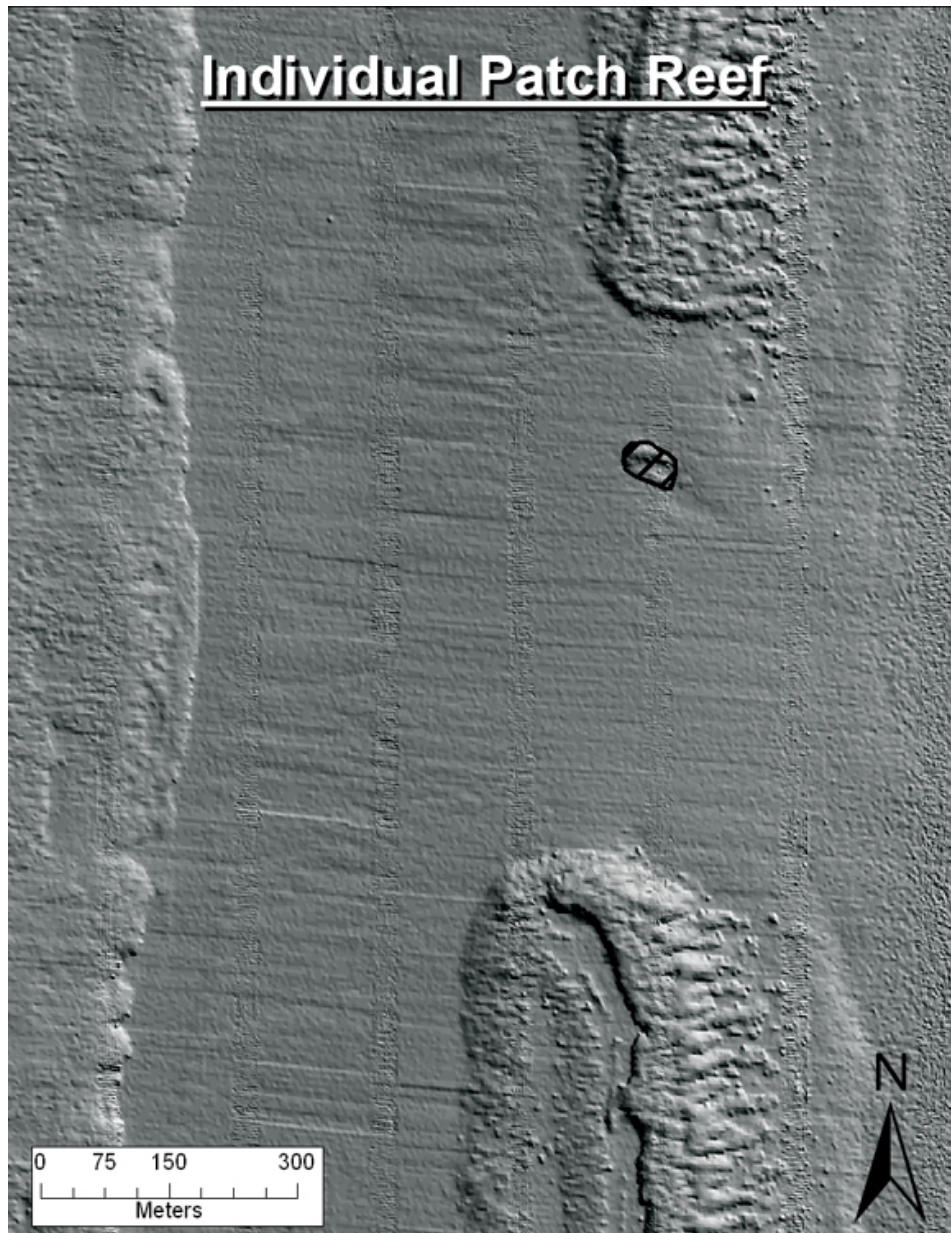

Figure 35

Aggregated Patch Reef: Clustered patch reefs that individually are too small (smaller than the MMU) or are too close together to map separately.

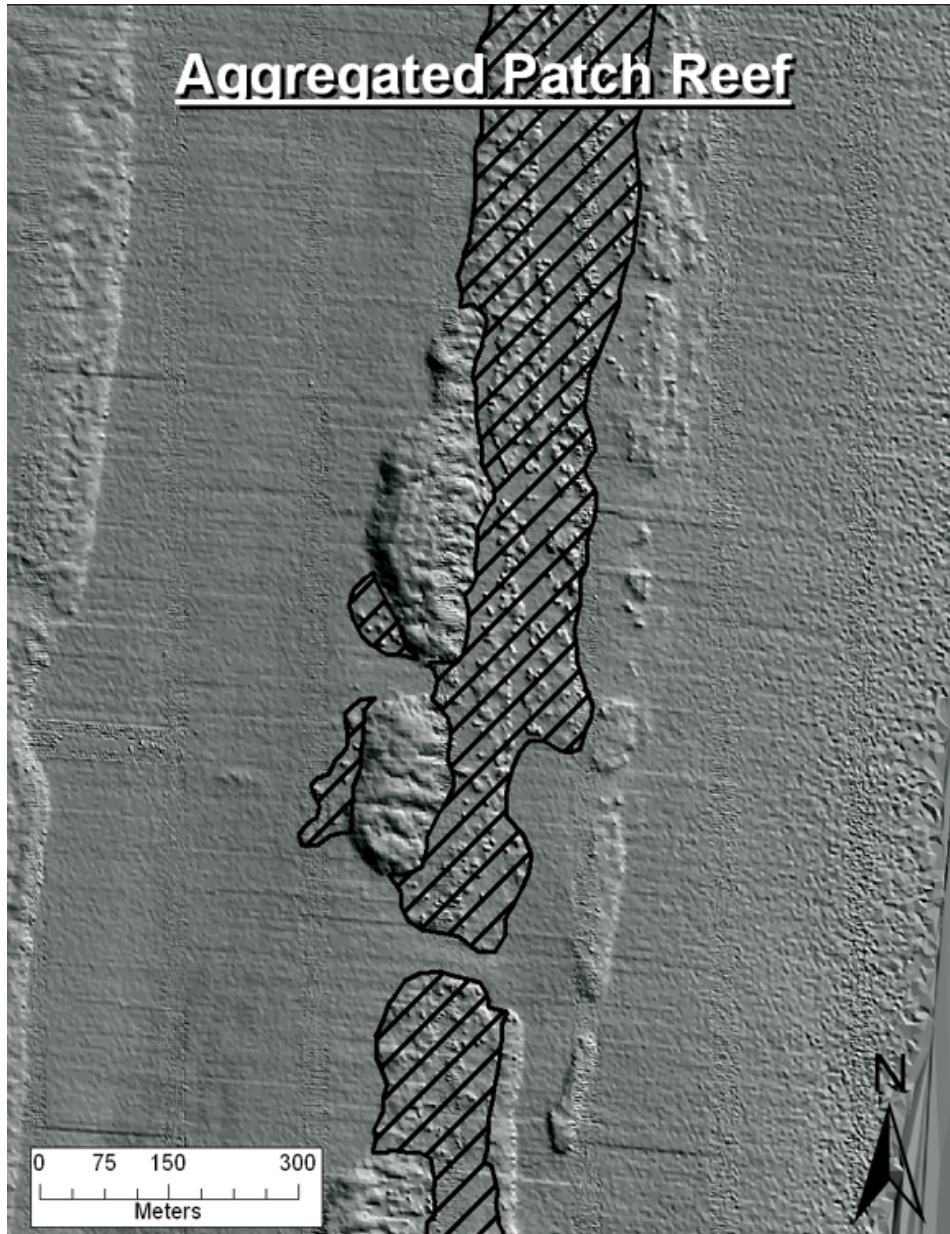

Figure 36

Scattered Coral/Rock in Unconsolidated Sediment: Primarily sand bottom with scattered rocks or small, isolated coral heads that are too small to be delineated individually (i.e., smaller than individual patch reef).

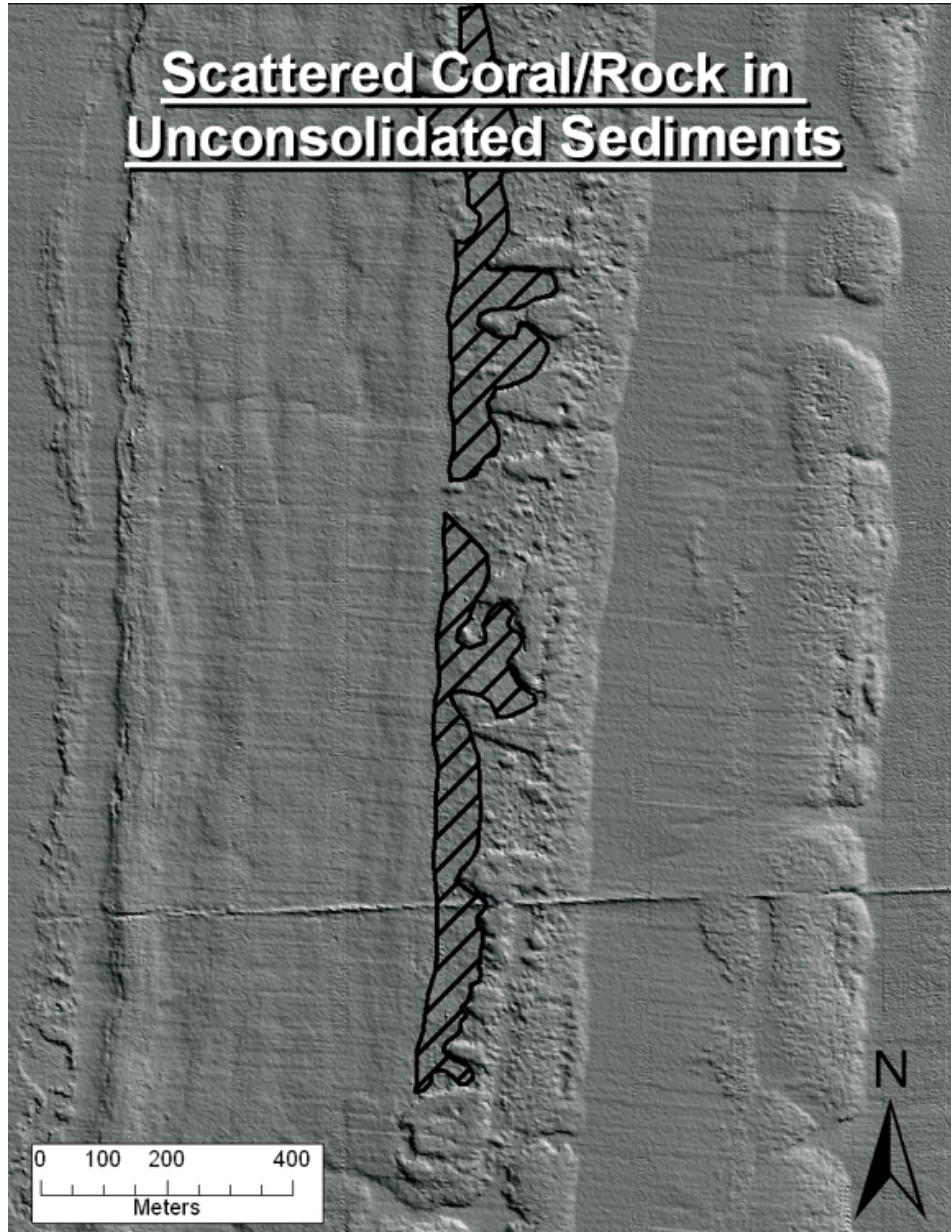

Figure 37

Colonized Pavement: Flat, low-relief, solid carbonate rock with coverage of macroalgae, hard coral, gorgonians, and other sessile invertebrates that are dense enough to partially obscure the underlying carbonate rock.

Colonized Pavement-Deep*: This category includes a transition zone from colonized pavement to colonized rubble. Since much of the rubble in the lee of the outer reef is at least partly consolidated, the differentiation between colonized pavement and rubble would be somewhat artificial.



Figure 38

Colonized Pavement-Shallow*: This category includes rubble in many areas, however, consolidated rubble fields are a less frequent feature in shallow water. Especially inshore of the ridge complexes, limited rubble is found and a wide, contiguous area of pavement is encountered. This area can have variable sand cover, which shifts according to wave-energy in response to weather. Thus, some of the colonized pavement will always be covered by shifting sand and the density of colonization will be highly variable.

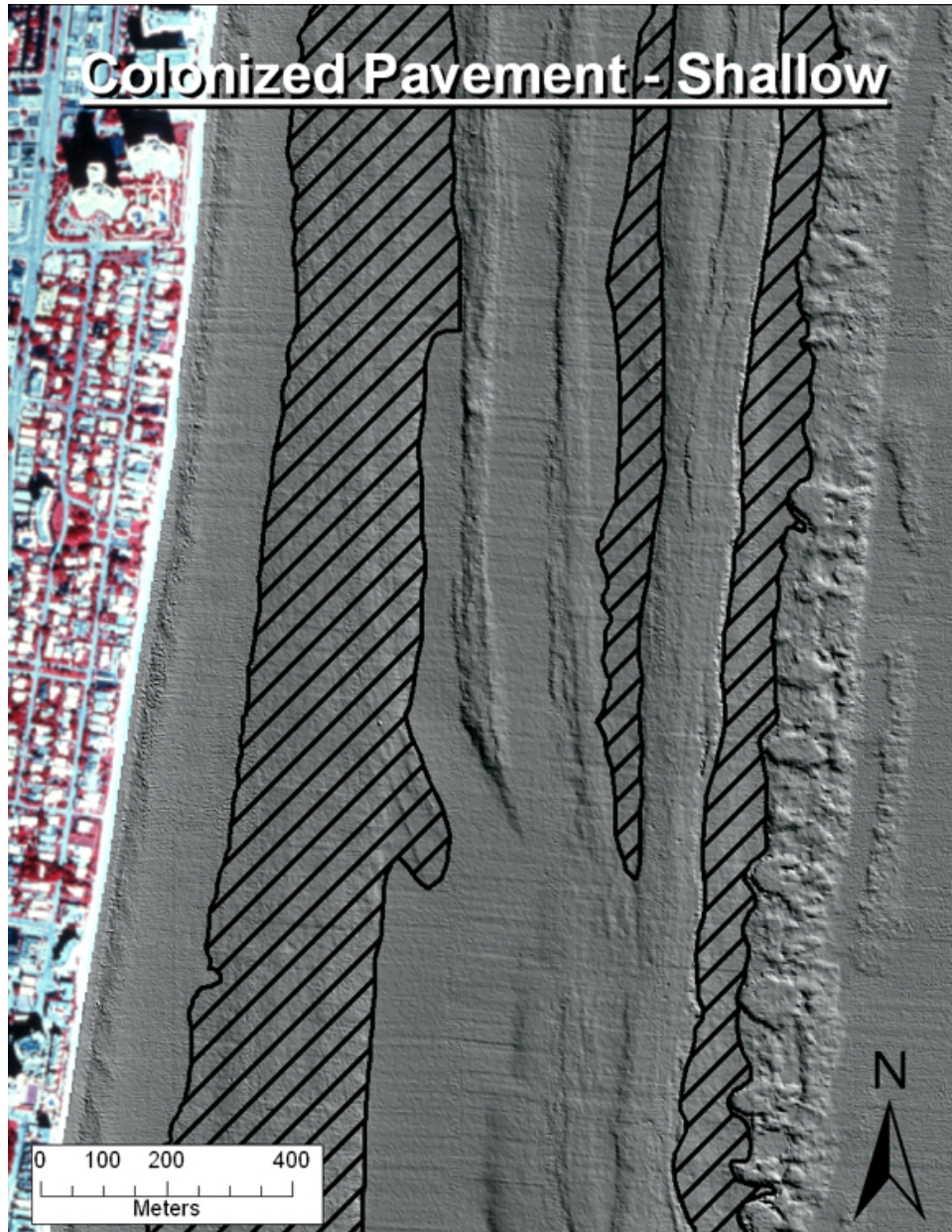

Figure 39

Ridge*: Linear, shore-parallel, low-relief features that appear to be submerged cemented beach dunes. Presumably, they are the foundation upon which the Linear Reefs grew and consist of early Holocene beachrock ridges, however, verification is needed (see Walker et al, *submitted*). The biological cover is similar to that of colonized pavement—a coverage of macroalgae, hard coral, gorgonians, and other sessile invertebrates that are dense enough to partially obscure the underlying carbonate rock.

Ridge-Deep*: While the geological provenance of the structure is not clear, its morphology suggests it to be a ridge of older age than the outer reef, possibly the structure on which the outer reef initiated. It consists of hardground with variable and shifting sand cover and benthic communities.

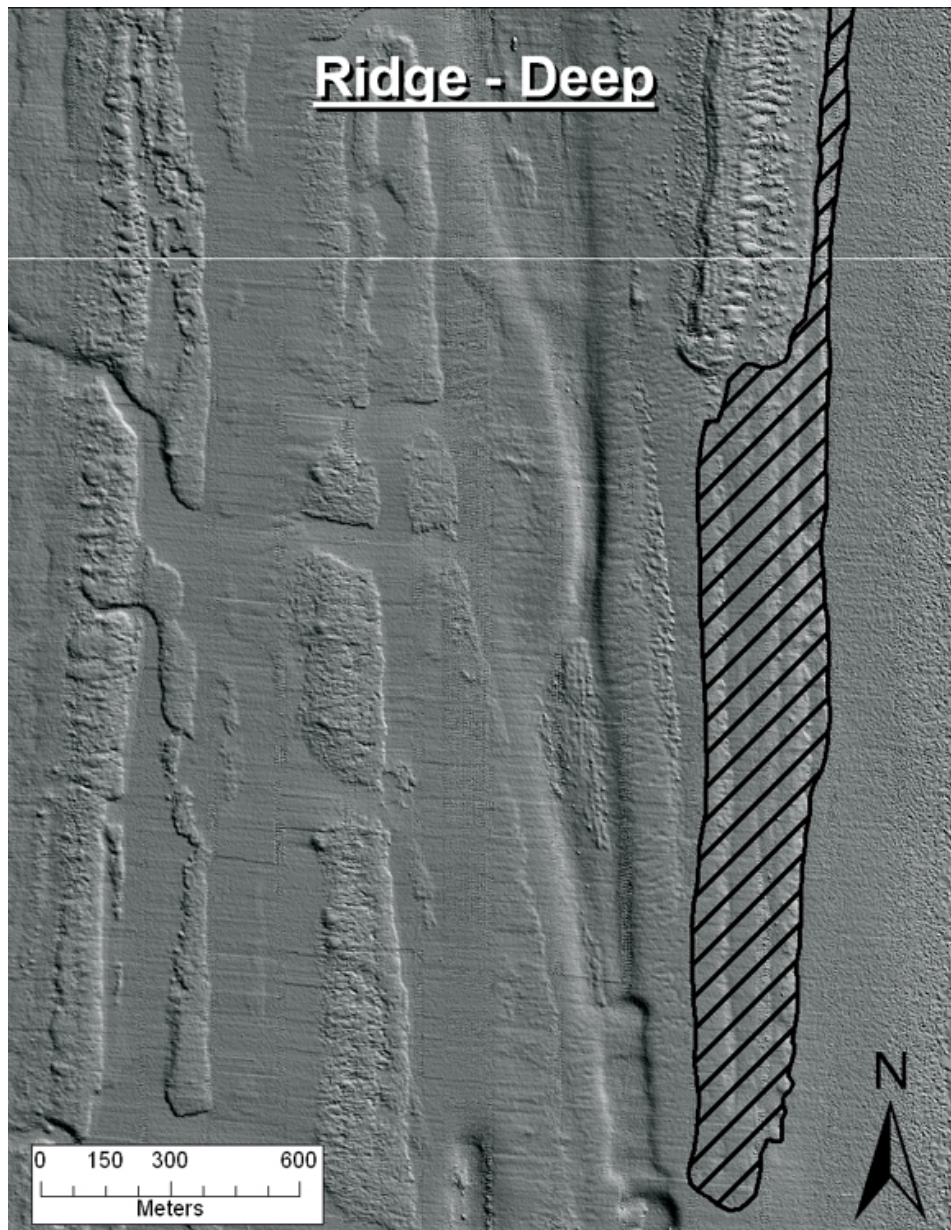

Figure 40

Ridge-Shallow*: Ridges found in shallow water near shore which are geomorphologically distinct, yet their benthic cover remains similar to the shallow colonized pavement communities on the surrounding hard-grounds. They presumably consist of early Holocene beachrock ridges with possibly some *Acropora* framestones however verification is needed (see Walker et al, *submitted*).

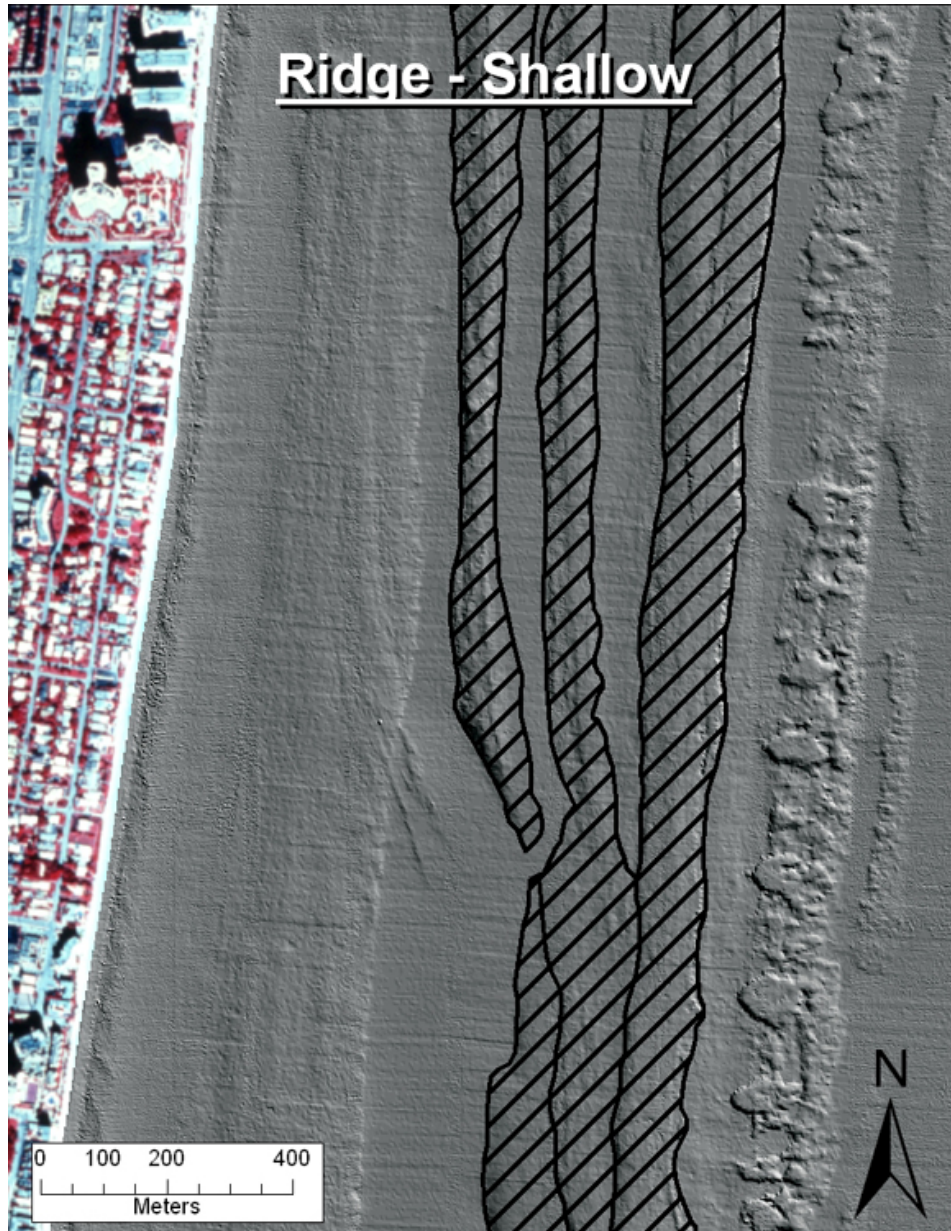

Figure 41

Unconsolidated Sediments: Unconsolidated sediment with less than 10 percent cover of submerged vegetation. Examples include sand and mud.

Sand: Coarse sediment typically found in areas exposed to currents or wave energy.

Sand-Deep*: This category is primarily encountered between the inner and middle reefs and the middle and outer reefs.

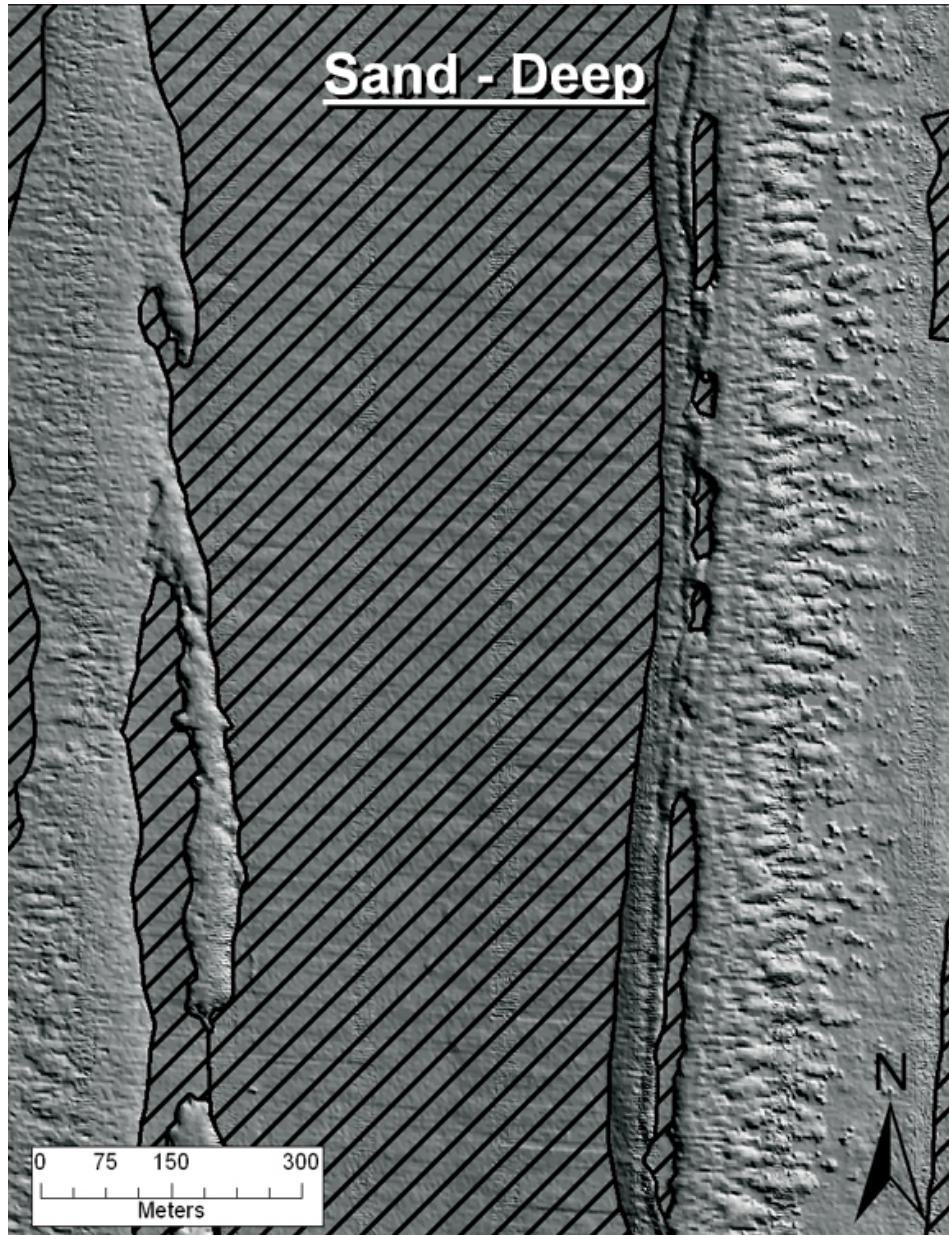

Figure 42

Sand-Shallow*: Shallow sand, besides the relatively stable sand wedge constituting the beach, is generally highly mobile. Large, mobile sand pockets are found on the areas of consolidated hardgrounds. It is believed that the sand movement is a deciding factor in the generation of benthic patterns.

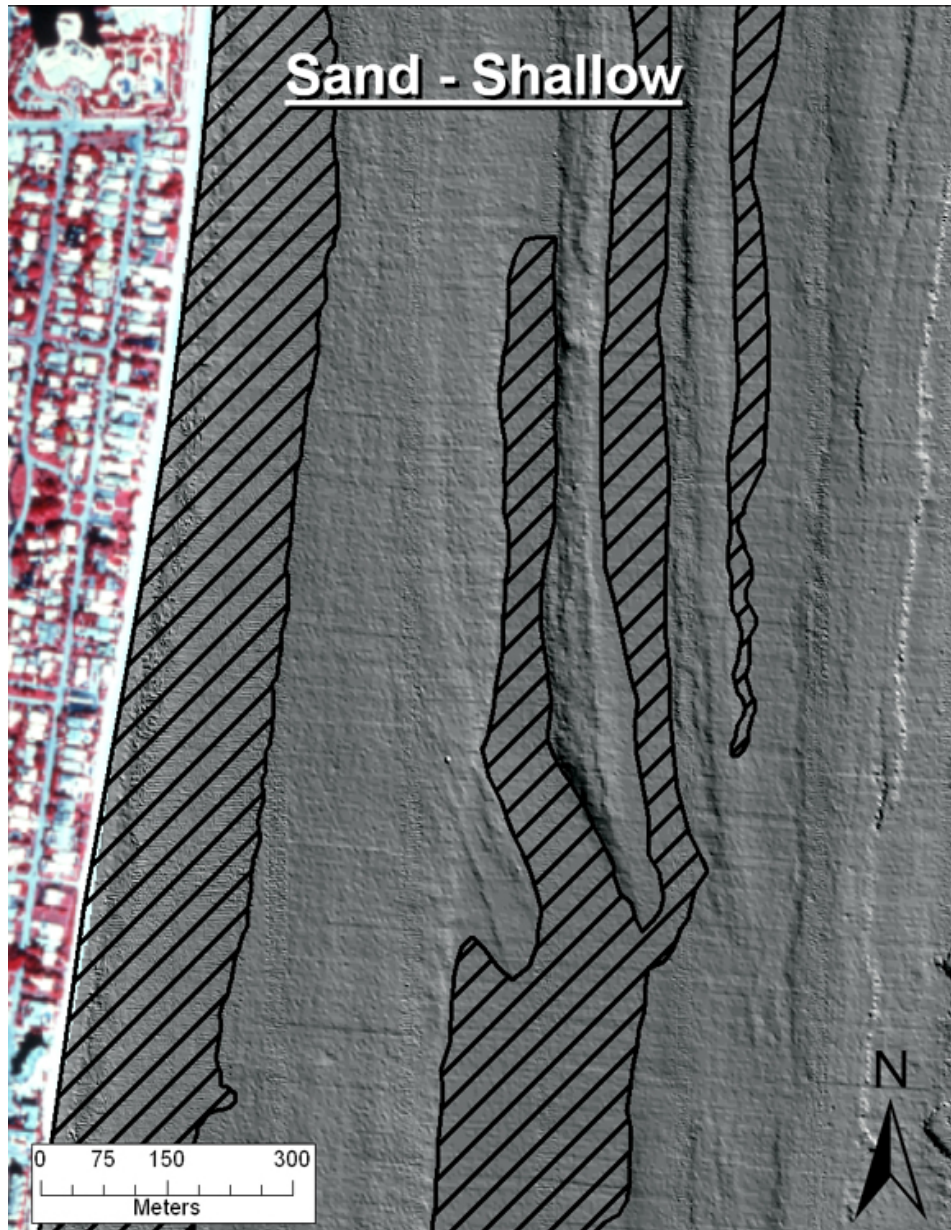

Figure 43

Other Delineations:

Artificial: Man-made habitats such as submerged wrecks, large piers, submerged portions of rip-rap jetties, and the shoreline of islands created from dredge spoil. The example below illustrates several submerged ships and piles of concrete placed there as part of Broward County's artificial reef program.

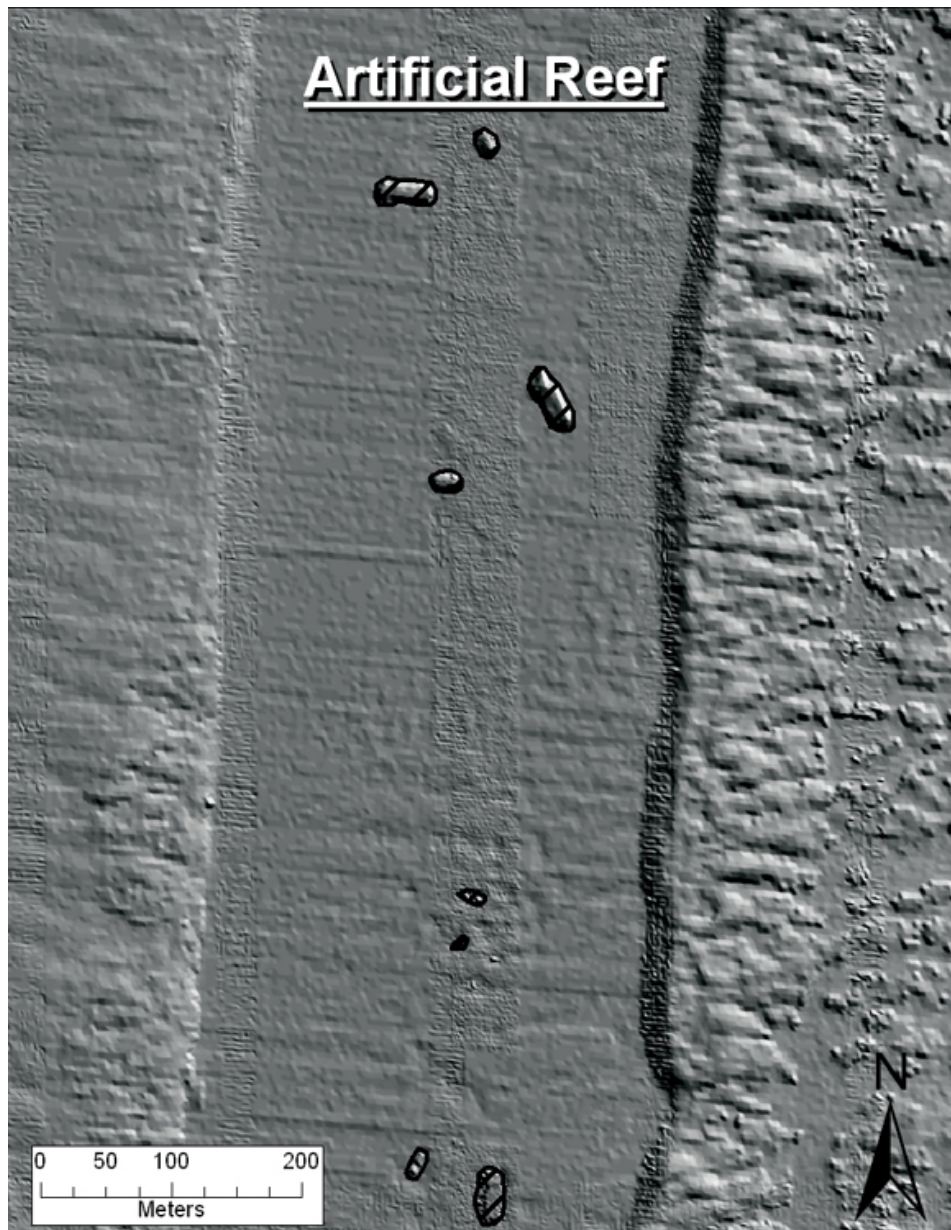

Figure 44

Wormrock*: This category is only encountered in the immediate nearshore areas, where the polychaete worms *Phragmatopoma caudata* (Sabeleriidae) build small bioherms consisting of their collated tubes. Wormrock is generally more ephemeral than the surrounding limestones. They also persist on jetties and piers throughout the county.

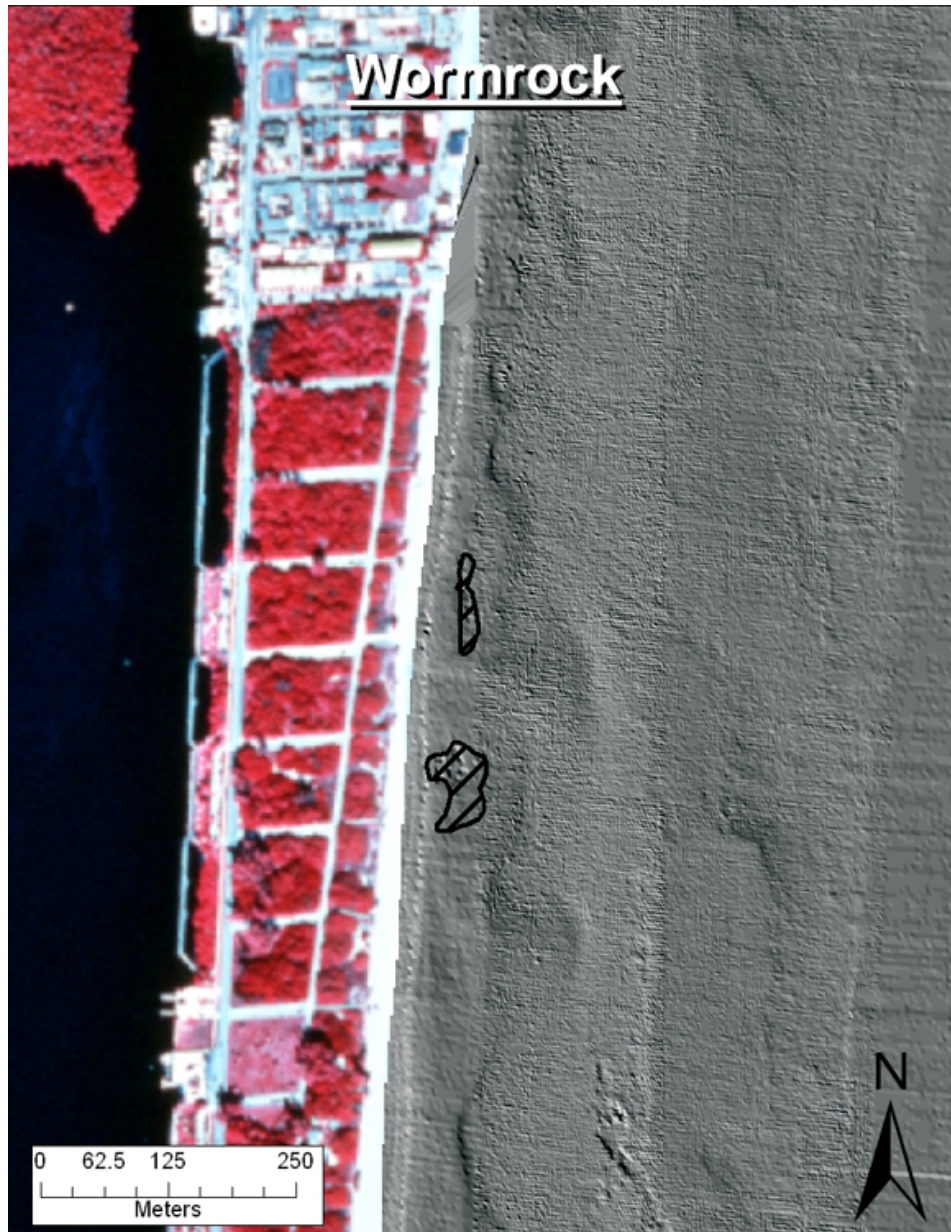

Figure 45

Inlet Channel*: All inlet channels in the survey area are maintained artificially and characterized by dredged bottom and spoil ridges at the flanks.

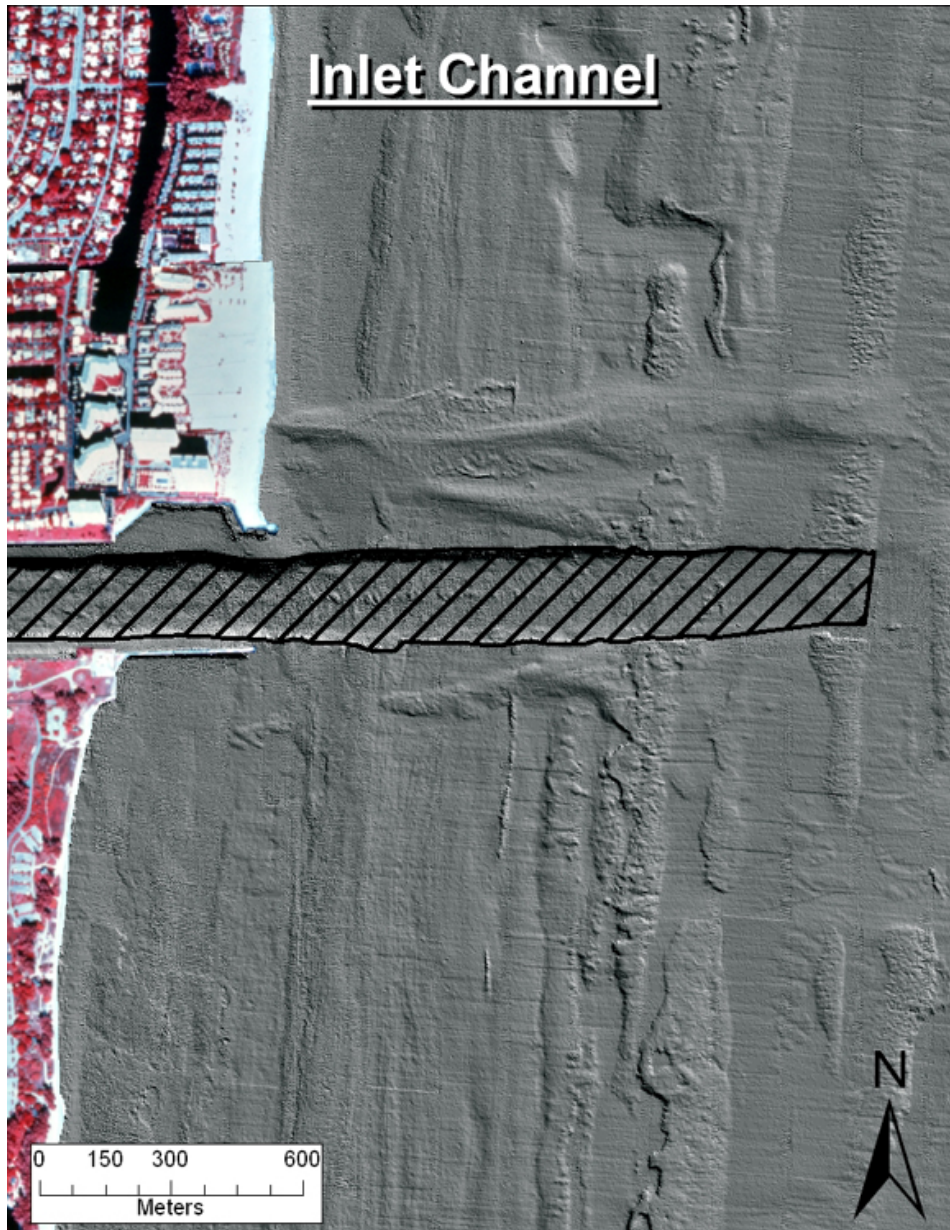

Figure 46

Sand Borrow Areas*: Several borrow pits from previous dredging projects are found throughout the survey area. While they are all found in sandy areas, at the bottom many of them expose limestone and thus small ridges or patch reefs are formed that can harbor a strongly localized and patchy, but sometimes dense, benthic fauna.

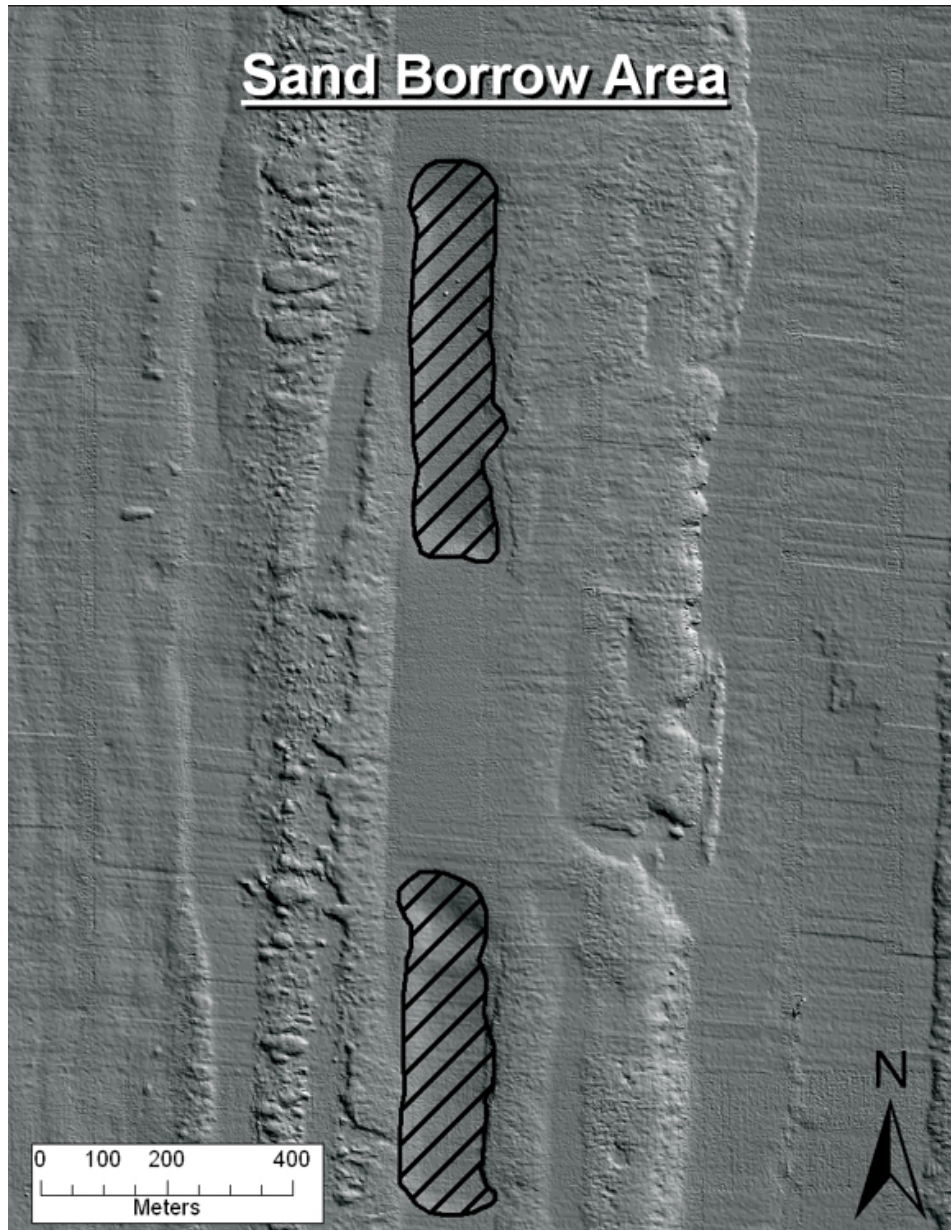

Figure 47

GROUNDTRUTHING

A total of 383 points were used for groundtruthing to help decide how data classes should be interpreted during the mapping process (Figure 48). These data were generally acquired by drifting with the boat and observing with a video camera, noting down points at regular intervals. The groundtruthing transects thus conveniently spanned many different habitats and were ideal to detect habitat transition zones. All groundtruthing points are included in the final GIS and linked to a table including their relevant information.

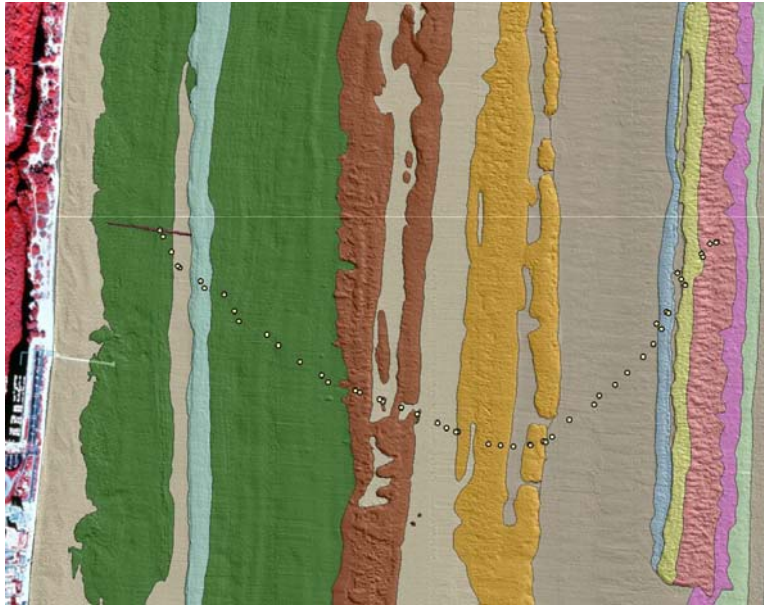

Figure 48: Example of a groundtruthing transect offshore John U. Lloyd State Park in south-central Broward County.

ACCURACY ASSESSMENT

A total of 300 target points, arranged on a grid over much of Broward County were chosen for accuracy assessment by confusion matrix approach (Ma and Redmond 1995). Points were arranged over a regular grid that ignored the underlying substratum to minimize sampling bias. After the map polygons were drawn and classified using the acoustic discrimination systems, groundtruth points, and LADS bathymetry, 278 actual accuracy assessment point locations were imported into the GIS to compare actual vs. mapped habitats (Figure 49).



Figure 49: Example of the accuracy assessment point grid off Hugh-Taylor-Birch State Park in central Broward County.

The accuracy assessment points were collected in a similar manner as the groundtruthing points with an underwater video drop camera to identify the habitat at the target locations. The benthic cover was described at each location by rating substrate and biological cover. The percent cover of substrate categories (Pavement, Sand, Rubble, and Coral) and the biological categories (Algae, Gorgonians, Sponge, and Coral) were estimated on a rating scale from 0 to 5, with each rating corresponding to a percent cover of the seafloor (Table 4).

Rating	% cover	Description
0	0%	None
1	5%	Rare
2	5-25%	Sparse
3	25-50%	Abundant
4	50-90%	Dominant
5	>90%	Tyrannical

Table 4: Rating scale used for the accuracy assessment benthic cover description.

The results of the accuracy assessment yielded a high level of accuracy (Figure 50). The mapped sand polygons showed a producer's accuracy (PA) of 96%, meaning out of 108 points that landed in sand polygons, 104 of them were groundtruthed as sand. Likewise user's accuracies (UA) were high in mapping

colonized pavement (95%) and linear reef (95%). The accuracy assessment showed good producer's accuracies for colonized pavement (83%) and linear reef (83%), and showed acceptable lower user's accuracy of sand (81%).

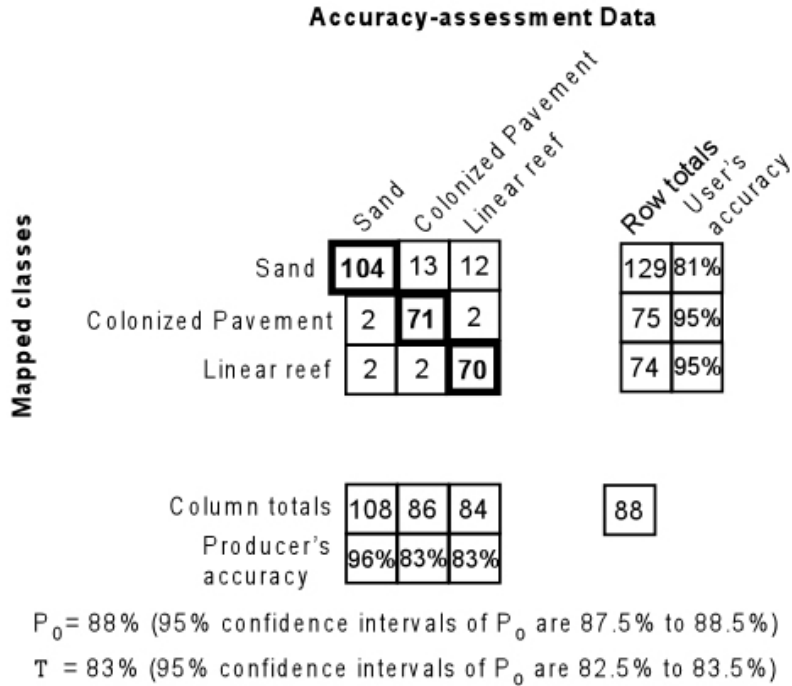

Figure 50: Confusion matrix for the generalized mapped classes.

These results are consistent with accuracy assessments using other mapping methods. Kendall et al (2001) reported a users accuracy of 86% and producers accuracy of 97% for Unconsolidated Sediments in the NOAA Puerto Rico and Virgin Island mapping effort. These results are similar, albeit slightly higher than the Broward County mapping effort's user's (81%) and producer's (96%) accuracies for Unconsolidated Sediments. For Coral Reef/Hardbottom, Kendall et al (2001) reported user's accuracy of 97% and producer's accuracy of 85%. The Broward County mapping split these into separate classes, Colonized Pavement and Linear Reef to illustrate another level of accuracy, however when these classes were combined, they yielded nearly identical accuracies (97% UA and 85% PA).

DISCUSSION

Several approaches can be taken for the evaluation of acoustic discrimination data. The usual method is a top-down approach (Hewitt et al, 2004) which investigates the relationship between acoustic groups and geomorphological data or findings. This approach generally takes the acoustic discrimination data, analyzes it, and then tries to make sense of it in the environment. However, due to the inaccuracies of spatial interpolation between survey lines and multiple surveys, this may not be the best approach. Alternatively, a bottom-up approach can be utilized, which combines acoustic data with environmental data to find meaningful correlations that can then be quantitatively applied. This was the approach used in the current investigation. Acoustic discrimination data supplemented other more spatially resolved data (LADS) and were added as a layer to the mapping product to aid in further discrimination of habitat classes. The combination of high resolution bathymetry, video groundtruthing, and *in situ* biological assessments were the foundation upon which the acoustic data were added. This approach yielded a much more accurate map than assessing the acoustic data separately and trying to make it fit. The results suggest that acoustic seafloor discrimination is not only able to differentiate sediment types (Hamilton *et al.* 1999; Morrison *et al.* 2001) but that it is also capable of detecting different benthic community types. From both calibration experiments and field survey data, it was apparent that different types of benthic community indeed produce unique echo classes on 200 kHz frequencies. Among the benthos, it was mainly the gorgonacean soft corals and large sponges that were implicated as the reason for different scatter classes.

The use of several data types aided greatly in the interpretation of bottom types. In particular the LADS survey was extremely useful to obtain a geomorphology-driven classification of reef habitats that is compatible with NOAA mapping categories. For the interpretation of the geomorphology, the QTC View and Echoplus surveys proved important, in particular to aid in the discrimination of habitats that were poorly resolved in the bathymetric datasets, such as pavements and rubble areas. These areas, however, generally had attracted benthic communities that were similar in composition to the nearby reefs. This generally consisted of a “reef-type” acoustic class that occurred in areas of flat topography, which aided in the delineation of rubble and flat hardground areas from sand. The areas of consolidated hardgrounds and rubble were better resolved by the QTC View and Echoplus. In particular in the southern sector of Broward County, south of Port Everglades, the QTC View and Echoplus data were of crucial importance to understanding the structure of the colonized pavements between the shoreline and the inner reef. From bathymetry data alone, it was not possible to distinguish whether the area was sandy or rocky; but thanks to the acoustic surveys, it rapidly became clear that the entire area consists of consolidated hardgrounds with generally only thin sand cover. Wherever composition of the seafloor was unclear, additional verification was sought by employing chirp subbottom sonar profiles, that showed good penetration and discrimination of clear subsurface reflectors to about 7m depth inside the substratum. It was thus possible to discriminate linear reefs very well from areas of deeper sand.

The results of the surveys suggest that the choice of hardware was appropriate. It is known that surface scatter from a statistically rough surface is inversely dependent on transducer opening angle (Clay and Sandness 1971; Medwin and Clay 1998). The smaller-opening angle 200 kHz transducer not only has a smaller footprint, which allows for higher “ecological” precision, but it also produces relatively higher backscatter, which suggests that it is a good tool for detecting surface structures like algae, seagrass, or sand ripples. It is believed that the detection of the algae was mostly based on their diffuse backscatter strength. It is also known that a lower-frequency signal will enter more deeply into the substratum than a higher-frequency signal (Medwin and Clay 1998). It is therefore possible that surveys on 50 kHz would have carried much subbottom information, which in our case was unwanted and could conceivably lead to misinterpretations. The 200 kHz survey failed to encode subbottom information and mainly detected scatter from the seafloor surface. Although the 50 and 200 kHz classifications agreed very well, it was decided to continue surveys with the 200 kHz signal, once it became available, since that would ensure that only surface and no subbottom information was collected.

The goal of this mapping effort was to provide habitat information as well as geomorphological description of the seafloor. Therefore, we attempted to provide habitat information that would allow differentiation between geomorphologically similar, but biologically different, areas. For this, both the QTC View and Echoplus provided very good results that were verified by biological samples. QTC View and Echoplus suggested two to three different benthic community classes that corresponded with the reef lines. Therefore, each linear reef was assigned a unique class to emphasize the fact that although we observed three parallel lines of linear reef, the benthic community on these linear reefs was different.

Besides the mapped difference in benthic classes among reefs, we also believe that within reef patterns of different faunal density are clearly encoded in the acoustic classes. For the evaluation of these smaller-scale patterns that do not necessarily follow geomorphological contours, it is difficult to evaluate the validity and meaning of either the QTC or the Echoplus acoustic ground discrimination by solely looking at the survey lines.

The steps involved in moving from data points in a plane to a closed surface involve resampling data points to a regular grid, transferring the information from the nearest true data points to the regridded data points, then interpolating surfaces in between the data points. Especially if different surveys are merged, it has to be assured that the classes, or levels of digital numbers such as E1 and E2, are internally coherent, which requires the development of further routines for data cleaning and quality control. Interpolation of the seafloor classification is aided by “enhancing” through the application of spatial statistical methods (Walter et al., 2002), in our case ordinary kriging (Middleton 2000; Papritz and Stein 2002).

Depending on data type, different methods of interpolation are necessary. Continuous data, such as the E1/E2 pairs obtained from the Echoplus or bathymetric measurements, can be analyzed with Geostatistical models like kriging or splining. These are based on the spatial autocorrelation of the samples (Middleton 2000) and, depending on the model chosen, are weighted heavily either towards a local or

global neighborhood for interpolation decisions. For categorical data, such as the QTC View classes, nearest-neighbor interpolation based either on Delauney triangulations or Voronoi polygons have to be employed (Middleton 2000). These operations showed in many of the present surveys, that indeed the assumption that the reefs would scatter differently from the surrounding flat areas was true, as was the assumption that within-reef patchiness existed. Resampled and interpolated data from individual surveys show promise of allowing a coherent mapping of within-reef patterns of faunal density. Problems presently encountered pertain to data coherence among adjacent surveys and need further investigation.

CONCLUSIONS

Maps outlining the entire Broward County sub-tidal seafloor from 0 to 35m depth classified into NOAA equivalent habitat classes are provided. Production of the maps was based on a variety of data types, such as LADS bathymetry, QTC View and Echoplus acoustic seafloor discrimination, biological investigations using photo-squares and line-intercept transects. The accuracy of the Broward maps is comparable to that achieved by the NOAA habitat maps in Puerto Rico and the US Virgin Islands (Kendall et al, 2001).

The results of this survey are a good example of how similar mapping products can be attained through different means. The method employed to map Broward County appears to equally and accurately illustrate the benthic community as more traditional methods such as photo interpretation. Similar methodology should be used in other areas where photo interpretation is not feasible. Economically, photo interpretation will always “win out” over other remote sensing methods like high resolution bathymetry, chirp sub-bottom profiles and acoustic surveys. However, sea floor mapping should always incorporate all available quality data to provide the most information to the map. In areas such as the southeast coast of Florida, where photo interpretation is precluded by turbidity, the techniques employed in this survey can be used to yield similar results. Moreover, the acoustic discrimination data add the ability to produce another layer in the habitat maps. The possibilities are still being explored, however, it is hoped that the acoustic data will be translatable into benthic community densities within the present habitats. This avenue is currently under investigation.

REFERENCES IN TEXT:

- Clay CS & Sandness GA (1971). Effect of beam width on acoustic signals scattered at a rough surface. *Advisory Group for Aerospace Research and Development. NATO Conference Proceedings, 21(90):1-8.*
- Davis JC (2002) *Statistics and data analysis in Geology*. 3rd edition. John Wiley and Sons., 638pp.
- Hamilton LJ, Mulhearn PJ, & Poeckert, R. (1999). Comparison of RoxAnn and QTC-View acoustic bottom classification system performance for the Cairns area, Great Barrier Reef, Australia. *Continental Shelf Research, 19:1577-1597.*
- Hamilton LJ. (2001). *Acoustic Seabed Classification Systems*. Department of Defence. Defence Science and Technology Organisation, 150 pp.
- Hewitt JE, Thrush SF, Legendre P, Funnell GA, Ellis J, & Morrison M (2004) Mapping of marine soft-sediment communities: integrated sampling for ecological interpretation. *Ecological Applications* 14(4): 1203-1216.
- Kendall M S, Kruer CR, Buja KR, Christensen JD, Finkbeiner M, & Monaco ME. 2001. NOAA Technical Memorandum NOS NCCOS CCMA 152 (On-Line). Methods Used to Map the Benthic Habitats of Puerto Rico and the US Virgin Islands. URL:<http://biogeo.nos.noaa.gov/projects/mapping/caribbean/startup.htm>. Silver Springs, MD: National Oceanic and Atmospheric Administration.
- Legendre P, Ellingsen KE, Bjørnbom E, Casgrain P (2002) Acoustic seabed classification: improved statistical methods. *Canadian Journal of Fisheries and Aquatic Sciences, 59*, 1085-1089.
- Ma Z, & Redmond RL. (1995). Tau coefficients for accuracy assessment of classification of remote sensing data. *Photogrammetric Engineering and Remote Sensing, 61:435-439.*
- Medwin H & Clay CS. (1998). *Fundamentals of Acoustical Oceanography*. Academic Press, 712 pp
- Middleton GV. (2000). *Data Analysis in the Earth Sciences using Matlab*. Prentice-Hall, 260 pp.
- Papritz A & Stein A. (2002). Spatial prediction by linear kriging. *In: Stein A, van der Meer F, Gorte B (eds.) Spatial Statistics for Remote Sensing*. Kluwer, Dordrecht: 83-113.
- Quester Tangent Corporation (2002). *QTC IMPACT™ acoustic seabed classification, user guide version 3.00. Integrated mapping, processing and classification toolkit*. Quester Tangent Corporation, Sidney, B.C., Canada.
- Seatronics (2000) Echoplus user and installation guide. SEA (Advanced products) LTd, 38 pp.
- Walker, B.K., B. Riegl, K. Banks, and R.E. Dodge. 2004. "Quaternary sea-level rise and reef backstepping in Southeast Florida." 10th International Coral Reef Symposium (ICRS), Okinawa, Japan, 28 June – 2 July, 2004. *In Review*.
- Walter DJ, Lambert DN, & Young DC. (2002). Sediment facies determination using acoustic techniques in a shallow-water carbonate environment, Dry Tortugas, Florida. *Marine Geology, 182:161-177.*

SUBMITTED ON 30 NOVEMBER 2004

PROJECT TEAM:

Principle Investigator:

Bernhard Riegl, PhD

GIS and map production:

Brian Walker, MSc

Research Assistants:

Ryan Moyer, MSc

Luz Hernandez-Cruz

John G. Foster

Christy Foster



Nova Southeastern University

Oceanographic Center

&

National Coral Reef Institute

8000 North Ocean Drive

Dania Beach, FL 33004

www.nova.edu/ocean

PI Phone: (954) 262 3671

Fax: (954) 262 4098

PI E-mail: rieglb@nsu.nova.edu

CD Contents

REPORT

Final Draft Report: NOAABrowardMappingDraftFINAL.doc
Final Draft Report Appendix: NOAABrowardMappingDraft report-Appendix 1.doc

GIS

ArcGIS9 mxd: BrowardCountyMappingGIS.mxd
Aerial mosaic: BrwdMosaic99.aux
BrwdMosaic99.bil
BrwdMosaic99.bil.xml
BrwdMosaic99.hdr
Brwdmosaic99.rrd
Accuracy Assessment: AccuracyAssessment_all.dbf
AccuracyAssessment_all.prj
AccuracyAssessment_all.sbn
AccuracyAssessment_all.sbx
AccuracyAssessment_all.shp
AccuracyAssessment_all.shp.xml
AccuracyAssessment_all.shx
Broward County Habitat Polygons: BrowardCountyHabitats_Draft_11_22_04.dbf
BrowardCountyHabitats_Draft_11_22_04.prj
BrowardCountyHabitats_Draft_11_22_04.sbn
BrowardCountyHabitats_Draft_11_22_04.sbx
BrowardCountyHabitats_Draft_11_22_04.shp
BrowardCountyHabitats_Draft_11_22_04.shp.xml
BrowardCountyHabitats_Draft_11_22_04.shx
BrowardHabitats-Habitat.lyr
BrowardHabitats-Modifier1.lyr
BrowardHabitats-Modifier1.lyr.xml
BrowardHabitats-Type.lyr
Echo Plus data: EchoPlus1to39merged.dbf
EchoPlus1to39merged.prj
EchoPlus1to39merged.sbn
EchoPlus1to39merged.sbx
EchoPlus1to39merged.shp
EchoPlus1to39merged.shp.xml
EchoPlus1to39merged.shx
Groundtruthing data: Groundtruth_all.dbf
Groundtruth_all.prj
Groundtruth_all.sbn
Groundtruth_all.sbx
Groundtruth_all.shp
Groundtruth_all.shp.xml
Groundtruth_all.shx

Broward County LADS bathymetry

broward total.aux
broward total.htm
broward total.jgw
broward total.jpg
broward total.jpg
broward total.prj
broward total.prj
broward total.rdd

QTC survey data:

20030917_Dania.dbf	20030927_Hollywood.dbf	20031015_LBS.dbf	20031208_Dania.dbf
20030917_Dania.prj	20030927_Hollywood.prj	20031015_LBS.prj	20031208_Dania.prj
20030917_Dania.sbn	20030927_Hollywood.sbn	20031015_LBS.sbn	20031208_Dania.sbn
20030917_Dania.sbx	20030927_Hollywood.sbx	20031015_LBS.sbx	20031208_Dania.sbx
20030917_Dania.shp	20030927_Hollywood.shp	20031015_LBS.shp	20031208_Dania.shp
20030917_Dania.shp.xml	20030927_Hollywood.shp.xml	20031015_LBS.shp.xml	20031208_Dania.shp.xml
20030917_Dania.shx	20030927_Hollywood.shx	20031015_LBS.shx	20031208_Dania.shx
20030918_Dania.dbf	20030929_Hollywood.dbf	20031020_LBS.dbf	20031209_Pompano.dbf
20030918_Dania.prj	20030929_Hollywood.prj	20031020_LBS.prj	20031209_Pompano.prj
20030918_Dania.sbn	20030929_Hollywood.sbn	20031020_LBS.sbn	20031209_Pompano.sbn
20030918_Dania.sbx	20030929_Hollywood.sbx	20031020_LBS.sbx	20031209_Pompano.sbx
20030918_Dania.shp	20030929_Hollywood.shp	20031020_LBS.shp	20031209_Pompano.shp
20030918_Dania.shp.xml	20030929_Hollywood.shp.xml	20031020_LBS.shp.xml	20031209_Pompano.shp.xml
20030918_Dania.shx	20030929_Hollywood.shx	20031020_LBS.shx	20031209_Pompano.shx
20030918_Hollywood.dbf	20031001_Hollywood.dbf	20031021_LBS.dbf	20031212_Pompano.dbf
20030918_Hollywood.prj	20031001_Hollywood.prj	20031021_LBS.prj	20031212_Pompano.prj
20030918_Hollywood.sbn	20031001_Hollywood.sbn	20031021_LBS.sbn	20031212_Pompano.sbn
20030918_Hollywood.sbx	20031001_Hollywood.sbx	20031021_LBS.sbx	20031212_Pompano.sbx
20030918_Hollywood.shp	20031001_Hollywood.shp	20031021_LBS.shp	20031212_Pompano.shp
20030918_Hollywood.shp.xml	20031001_Hollywood.shp.xml	20031021_LBS.shp.xml	20031212_Pompano.shp.xml
20030918_Hollywood.shx	20031001_Hollywood.shx	20031021_LBS.shx	20031212_Pompano.shx
20030920_Hollywood.dbf	20031003_Hollywood.dbf	20031022_LBS.dbf	20031215_Hollywood.dbf
20030920_Hollywood.prj	20031003_Hollywood.prj	20031022_LBS.prj	20031215_Hollywood.prj
20030920_Hollywood.sbn	20031003_Hollywood.sbn	20031022_LBS.sbn	20031215_Hollywood.sbn
20030920_Hollywood.sbx	20031003_Hollywood.sbx	20031022_LBS.sbx	20031215_Hollywood.sbx
20030920_Hollywood.shp	20031003_Hollywood.shp	20031022_LBS.shp	20031215_Hollywood.shp
20030920_Hollywood.shp.xml	20031003_Hollywood.shp.xml	20031022_LBS.shp.xml	20031215_Hollywood.shp.xml
20030920_Hollywood.shx	20031003_Hollywood.shx	20031022_LBS.shx	20031215_Hollywood.shx
20030923_Hollywood.dbf	20031009_FtLaud.dbf	20031113_FtLaud.dbf	20040106_FtLaud.dbf
20030923_Hollywood.prj	20031009_FtLaud.prj	20031113_FtLaud.prj	20040106_FtLaud.prj
20030923_Hollywood.sbn	20031009_FtLaud.sbn	20031113_FtLaud.sbn	20040106_FtLaud.sbn
20030923_Hollywood.sbx	20031009_FtLaud.sbx	20031113_FtLaud.sbx	20040106_FtLaud.sbx
20030923_Hollywood.shp	20031009_FtLaud.shp	20031113_FtLaud.shp	20040106_FtLaud.shp
20030923_Hollywood.shp.xml	20031009_FtLaud.shp.xml	20031113_FtLaud.shp.xml	20040106_FtLaud.shp.xml
20030923_Hollywood.shx	20031009_FtLaud.shx	20031113_FtLaud.shx	20040106_FtLaud.shx
20030924_Hollywood.dbf	20031010_FtLaud.dbf	20031125_FtLaud.dbf	20040109_Pompano.dbf
20030924_Hollywood.prj	20031010_FtLaud.prj	20031125_FtLaud.prj	20040109_Pompano.prj
20030924_Hollywood.sbn	20031010_FtLaud.sbn	20031125_FtLaud.sbn	20040109_Pompano.sbn
20030924_Hollywood.sbx	20031010_FtLaud.sbx	20031125_FtLaud.sbx	20040109_Pompano.sbx
20030924_Hollywood.shp	20031010_FtLaud.shp	20031125_FtLaud.shp	20040109_Pompano.shp
20030924_Hollywood.shp.xml	20031010_FtLaud.shp.xml	20031125_FtLaud.shp.xml	20040109_Pompano.shp.xml
20030924_Hollywood.shx	20031010_FtLaud.shx	20031125_FtLaud.shx	20040109_Pompano.shx
20030925_Hollywood.dbf	20031012_FtLaud.dbf	20031126_Pompano.dbf	20040113_Pompano.dbf
20030925_Hollywood.prj	20031012_FtLaud.prj	20031126_Pompano.prj	20040113_Pompano.prj
20030925_Hollywood.sbn	20031012_FtLaud.sbn	20031126_Pompano.sbn	20040113_Pompano.sbn
20030925_Hollywood.sbx	20031012_FtLaud.sbx	20031126_Pompano.sbx	20040113_Pompano.sbx
20030925_Hollywood.shp	20031012_FtLaud.shp	20031126_Pompano.shp	20040113_Pompano.shp
20030925_Hollywood.shp.xml	20031012_FtLaud.shp.xml	20031126_Pompano.shp.xml	20040113_Pompano.shp.xml
20030925_Hollywood.shx	20031012_FtLaud.shx	20031126_Pompano.shx	20040113_Pompano.shx
20030926_Hollywood.dbf	20031013_FtLaud.dbf	20031205_Pompano.dbf	20040114_Pompano.dbf
20030926_Hollywood.prj	20031013_FtLaud.prj	20031205_Pompano.prj	20040114_Pompano.prj
20030926_Hollywood.sbn	20031013_FtLaud.sbn	20031205_Pompano.sbn	20040114_Pompano.sbn
20030926_Hollywood.sbx	20031013_FtLaud.sbx	20031205_Pompano.sbx	20040114_Pompano.sbx
20030926_Hollywood.shp	20031013_FtLaud.shp	20031205_Pompano.shp	20040114_Pompano.shp
20030926_Hollywood.shp.xml	20031013_FtLaud.shp.xml	20031205_Pompano.shp.xml	20040114_Pompano.shp.xml
20030926_Hollywood.shx	20031013_FtLaud.shx	20031205_Pompano.shx	20040114_Pompano.shx

20040115_FtLaud.dbf	20040202_Hollywood.shp	20040715_Deerfield.prj	Corridor1_Boca.shp.xml
20040115_FtLaud.prj	20040202_Hollywood.shp.xml	20040715_Deerfield.sbn	Corridor1_Boca.shx
20040115_FtLaud.sbn	20040202_Hollywood.shx	20040715_Deerfield.sbx	Corridor2_Pompano.dbf
20040115_FtLaud.sbx	20040203_Hollywood.dbf	20040715_Deerfield.shp	Corridor2_Pompano.prj
20040115_FtLaud.shp	20040203_Hollywood.prj	20040715_Deerfield.shp.xml	Corridor2_Pompano.sbn
20040115_FtLaud.shp.xml	20040203_Hollywood.sbn	20040715_Deerfield.shx	Corridor2_Pompano.sbx
20040115_FtLaud.shx	20040203_Hollywood.sbx	20040721_Boca.dbf	Corridor2_Pompano.shp
20040116_Hillsboro.dbf	20040203_Hollywood.shp	20040721_Boca.prj	Corridor2_Pompano.shp.xml
20040116_Hillsboro.prj	20040203_Hollywood.shp.xml	20040721_Boca.sbn	Corridor2_Pompano.shx
20040116_Hillsboro.sbn	20040203_Hollywood.shx	20040721_Boca.sbx	Corridor3_FtLaud.dbf
20040116_Hillsboro.sbx	20040213_FtLaud.dbf	20040721_Boca.shp	Corridor3_FtLaud.prj
20040116_Hillsboro.shp	20040213_FtLaud.prj	20040721_Boca.shp.xml	Corridor3_FtLaud.sbn
20040116_Hillsboro.shp.xml	20040213_FtLaud.sbn	20040721_Boca.shx	Corridor3_FtLaud.sbx
20040116_Hillsboro.shx	20040213_FtLaud.sbx	20040723_Boca.dbf	Corridor3_FtLaud.shp
20040122_Pompano.dbf	20040213_FtLaud.shp	20040723_Boca.prj	Corridor3_FtLaud.shp.xml
20040122_Pompano.prj	20040213_FtLaud.shp.xml	20040723_Boca.sbn	Corridor3_FtLaud.shx
20040122_Pompano.sbn	20040213_FtLaud.shx	20040723_Boca.sbx	Corridor4_Dania.dbf
20040122_Pompano.sbx	20040401_Hollywood.dbf	20040723_Boca.shp	Corridor4_Dania.prj
20040122_Pompano.shp	20040401_Hollywood.prj	20040723_Boca.shp.xml	Corridor4_Dania.sbn
20040122_Pompano.shp.xml	20040401_Hollywood.sbn	20040723_Boca.shx	Corridor4_Dania.sbx
20040122_Pompano.shx	20040401_Hollywood.sbx	20040728_Boca.dbf	Corridor4_Dania.shp
20040130_Dania.dbf	20040401_Hollywood.shp	20040728_Boca.prj	Corridor4_Dania.shp.xml
20040130_Dania.prj	20040401_Hollywood.shp.xml	20040728_Boca.sbn	Corridor4_Dania.shx
20040130_Dania.sbn	20040401_Hollywood.shx	20040728_Boca.sbx	NorthBrowardBorrowAreas.dbf
20040130_Dania.sbx	20040713_Boca.dbf	20040728_Boca.shp	NorthBrowardBorrowAreas.prj
20040130_Dania.shp	20040713_Boca.prj	20040728_Boca.shp.xml	NorthBrowardBorrowAreas.sbn
20040130_Dania.shp.xml	20040713_Boca.sbn	20040728_Boca.shx	NorthBrowardBorrowAreas.sbx
20040130_Dania.shx	20040713_Boca.sbx	Corridor1_Boca.dbf	NorthBrowardBorrowAreas.shp
20040202_Hollywood.dbf	20040713_Boca.shp	Corridor1_Boca.prj	NorthBrowardBorrowAreas.shx
20040202_Hollywood.prj	20040713_Boca.shp.xml	Corridor1_Boca.sbn	
20040202_Hollywood.sbn	20040713_Boca.shx	Corridor1_Boca.sbx	
20040202_Hollywood.sbx	20040715_Deerfield.dbf	Corridor1_Boca.shp	