

LOW-IMPACT DEVELOPMENT & GREEN INFRASTRUCTURE:

Pollution Reduction Guidance for Water Quality in Southeast Florida

August 22, 2019

Prepared for:

Coral Reef Conservation Program (CRCP)
Florida Department of Environmental Protection (FDEP)
1277 NE 79th Street Causeway
Miami, FL 33138

Prepared by:

Eban Bean, Ph.D., P.E.
Lynn Jarrett
Jennison Kipp Searcy
Mary Szoka

Program for Resource Efficient Communities (PREC), Center for Land Use Efficiency (CLUE)
Department of Agricultural & Biological Engineering (ABE)
Institute of Food and Agricultural Sciences (IFAS)
University of Florida (UF)

This report was funded in part by the Florida Department of Environmental Protection, Office of Resilience and Coastal Protection. The views expressed herein are those of the author(s) and do not necessarily reflect the views of the State of Florida or any of its sub-agencies.

Table of Contents

Executive Summary.....	viii
1. Introduction	1
1.1. Purpose of Manual and Intended Users	4
1.2. Manual Organization	5
1.3. Impacts of Urbanization on the Environment	5
1.4. Terminology in Practice	12
1.5. Goals of Low Impact Development.....	13
2. Local Environmental Context.....	17
2.1. Hydrogeologic Characteristics	17
2.2. Unique Challenges	25
2.3. Regulatory Framework	35
2.4. Local Case Studies.....	41
3. Site Planning.....	44
3.1. Site Assessment	45
3.2. Site Resource Protection.....	48
4. Plan for stormwater control measures.....	54
4.1. Drainage and Treatment Planning: Stormwater Management	54
4.2. Pollutant Treatment Processes.....	59
4.3. Treatment Train Approach.....	64
5. Low Impact Development Stormwater Control Measures	69
5.1. Introduction	69
5.2. Non-structural Low Impact Development Stormwater Control Measures	70
5.3. General Structural Stormwater Control Method Design Criteria	76
5.4. Structural Stormwater Control Methods.....	80
5.5. Flow Control Stormwater Control Methods	103
5.6. Flow-through SCMs.....	106
5.7. Off-lot Stormwater Control Methods	111
5.8. Other Treatment Systems.....	117
6. Assess Applicability of Candidate SCMs	124
6.1. Identifying Design & Implementation Constraints	125
6.2. Moving from Design to Practice: Putting the pieces together	127
6.3. Construction Standards and Considerations	132
7. Operation and Maintenance of SCMs	145
7.1. Operation Considerations.....	145
7.2. Maintenance Procedures and Frequency.....	146
7.3. Regulatory Maintenance Requirements.....	148
7.4. Florida-Friendly Landscaping™	148
8. Performance Verification & Validation	151
8.1. Volume and Peak Flow Reduction	151
8.2. Water Quality Standards and Indicators.....	153

9. Public Education	155
9.1. Need for public understanding of water connections, local watersheds, and the hydrologic cycle	155
9.2. Role of Local Governments.....	156
9.3. Community Participation: Role of citizens, landowners, business owners, homeowners	157
9.4. Successful Strategies (Case Studies, Public Outreach Campaigns)	159
10. Ancillary Community Benefits	162
10.1. Ecological and Environmental.....	162
10.2. Economic.....	163
10.3. Social and Cultural	163
11. Conclusions and Next Steps.....	165
11.1. Conclusions	165
11.2. Recommended Next Steps.....	166

List of Figures

Figure 1-1. Map of coral reefs (northern portion) off Southeast Florida and the counties overseeing them.....	3
Figure 1-2. PAH compounds are found in coal-tar-based sealcoats.....	9
Figure 1-3. Consider site vegetation and topography, maintain natural hydrology, and limit compaction of soils.....	14
Figure 2-1. Hydrologic soils group and flood frequency for Miami-Dade County.....	19
Figure 2-2. Hydrologic soils group and flood frequency for Broward County.....	20
Figure 2-3. Hydrologic soils group and flood frequency for Palm Beach County.....	21
Figure 2-4. Hydrologic soils group and flood frequency for Martin County.....	22
Figure 2-5. Normal monthly temperatures and precipitation totals from the West Palm Beach International Airport (1989–2018).....	23
Figure 2-6. Boynton Beach rainfall depth, duration, and frequency data.....	24
Figure 2-7. Current (2019) depth to the seasonal high groundwater table.....	27
Figure 2-8. Approximate duration of seasonal high groundwater table.....	28
Figure 2-9. Watersheds contributing to estuary inlets and the primary canal system in Southeast Florida.....	29
Figure 2-10. Current land use.....	30
Figure 2-11. Reef Hope Project (Photos: David Snyder & Dr. Charlie Gregory).....	31
Figure 2-12. Known, likely, and somewhat-likely (SWL) locations of sewers and septic systems.....	33
Figure 2-13. Impaired waters with existing TMDLs and BMAPs.....	39
Figure 2-14. Seminole sculptural biofiltration wall. (Photo: Michael Singer Studio).....	42
Figure 2-15. Living shoreline mangrove planter in Lake Worth Beach. (Photo: Michael Singer Studio) ..	42
Figure 3-1. Decomposing plants release nitrogen stored in their tissues.....	47
Figure 3-2. Avoid complete site clearing. Retain trees where possible.....	49
Figure 3-3. Depth of soil compaction varies with vehicle weight per unit area.....	53
Figure 4-1. Traditional vs. LID designs for a large mixed-use community.....	55
Figure 4-2. Pavement lengths with different road designs. (Graphic from Southworth, M. Ben-Joseph, E. (1997). Streets and the Shaping of Towns and Cities. McGraw-Hill.).....	56
Figure 4-3. Roadside swales replace curbs and gutters along a residential street. (Photo: UF PREC) ...	57
Figure 4-4. Small residential lots, multi-story buildings, and short driveways on back alleys reduce impervious areas.....	58
Figure 4-5. Schematic of “dual-pond” offline treatment system.....	68
Figure 5-1. Stormwater ponds with and without littoral zone plantings. (Photos: UF PREC).....	76
Figure 5-2. Compost for soil amendment. (Lifesoiils).....	81
Figure 5-3. Percent annual runoff retention for given cistern storage volume, in inches over green roof area.....	84
Figure 5-4. Section view of an extensive green roof (usually no public access and minimal management).....	85
Figure 5-5. Intensive green roof section (usually active function).....	85
Figure 5-6. Views of the green roof at Miami-Dade Children’s Courthouse.....	86
Figure 5-7. A cistern for storing rainwater.....	87

Figure 5-8. Installation of underground exfiltration media, Madera subdivision, Alachua County, Florida. [Photo, UF-PREC].....	90
Figure 5-9. Typical cross section of permeable pavement.....	91
Figure 5-10. Typical wet infiltration trench.....	95
Figure 5-11. Typical cross-section of a bioretention area. Plan view of a rain garden.....	97
Figure 5-12. Sample design for an infiltration box.....	99
Figure 5-13. Sidewalk infiltration planter box.....	100
Figure 5-14. Vegetated swale at the University of Florida's SW Recreation Center.....	101
Figure 5-15. Diagram of a simple flow splitter box. (Source: Massachusetts Clean Water Toolkit).....	104
Figure 5-16. Level spreader distributing stormwater to buffer strip.....	105
Figure 5-17. Second generation baffle box schematic and installation.....	110
Figure 5-18. Typical cross-section of an infiltration basin.....	112
Figure 5-19. 3-D topographic plan for an enhanced stormwater pond. (Photo: UF PREC)	113
Figure 5-20. Phosphorous cycle in enhanced stormwater ponds.....	114
Figure 5-21. Floating wetlands in Tumblin Creek Stormwater Park. (Photo: K. Songer)	117
Figure 5-22. Schematic of an in-ground nitrogen -reducing biofilter. (Graphic: Florida Department of Health).....	118
Figure 5-23. John's Island oyster reef restoration 2009-2013.	121
Figure 5-24. Before and after photos of Palm Beach Par Three Mangrove Planter.	123
Figure 6-1. Rural to urban transects and suitable LID SCMs. (Graphic by Duany Plater-Zyberk & Company)	128
Figure 6-2. Conceptual stormwater treatment system design methodology flow chart. [Adapted from Huber et al. (2005). Evaluation of best management practices.]	129
Figure 6-3. Street cross-section, Bonita Springs Downtown Improvements Project.....	130
Figure 6-4. Typical construction fill can dramatically increase leachable phosphorus and raise pH levels, which also increases the solubility of many metals. (Photo: UF PREC)	133
Figure 6-5. Check dams for small drainage channels.....	139
Figure 6-6. Side views of in-stream bioreactors (a) wall or (b) bed.....	140
Figure 6-7. Perimeter trench sand filter. (Image: Minnesota Pollution Control Agency)	141
Figure 7-1. Clogged drawdown orifice. (Photo: Tim Kelly Wood Environment & Infrastructure Solutions, Inc.).....	147
Figure 7-2. Sedimentation in inlet pipes. (Photo: Tim Kelly Wood Environment & Infrastructure Solutions, Inc.).....	147
Figure 7-3. Failure of permeable pavement. (Photo: Tim Kelly, Wood Environment & Infrastructure Solutions)	148
Figure 9-1. Poster for Scoop the Poop campaign.....	160
Figure 9-2. Volunteers planting the Lasalle Bioswale in Jacksonville, FL.....	161
Figure 10-1. Black skimmers on constructed island, Lake Worth Estuary.	162

List of Tables

Table 3-1.	Characteristics of NRCS Hydrologic Soil Groups	52
Table 4-1.	Water treatment processes associated with BMP options, pollutants removed, and description.	64
Table 4-2.	Functional aspects of LID techniques.....	66
Table 5-1.	Median TP and TN loads and unit removal costs measured in recovered sediment from 14 Florida locations.	75
Table 5-2.	Estimated evapotranspiration rate, relative to groundwater depth.....	79
Table 5-3.	Water storage available in soil above the water table.	79
Table 7-1.	Maximum recommended nitrogen applications (lbs.) per 1,000 sq. ft. of turfgrass.....	149

Executive Summary

The pattern of land development in Southeast Florida has created a legacy of infrastructure that regularly exports pollutants from the land into the estuarine and marine waters, adversely affecting the coral reef ecosystem. Along with rapid population growth and urbanization in Southeast Florida, Land-Based Sources of Pollution (LBSP) loads from anthropogenic sources have increased in both intensity (frequency and duration) and in total loading to the natural environment. Water, whether as runoff, pipe discharge, or groundwater flow, is the medium that conveys pollutants – nutrients, sediments, metals, hydrocarbons, and pathogens – from the land to adjacent waters. Conventional stormwater management minimally addresses the source of these complex LBSP problems and have typically focused on the quantity of water. Increasingly stringent water quality standards and restoration efforts implemented to meet water quality standards (Low Impact Development [LID], Green Infrastructure [GI], source control, careful site planning in new and redevelopment areas, and use of Stormwater Control Measures [SCMs]) have the potential to mitigate some of the most adverse effects of LBSP on water quality and coral reef ecosystem habitats—such as mangroves, seagrass, hard bottom, unconsolidated sediment, and oyster habitats—in the region.

The purpose of this LID and GI manual is to provide an overview of potential strategies for reducing and managing LBSP in Southeast Florida at the project scale. Incorporating LID principles and GI practices into a site design needs to begin at the start of the design process and be carried through to completion. Therefore, this manual is divided into chapters that address the various steps in the process, from beginning to end.

The manual begins by presenting the relevant background, introducing fundamentals of stormwater management and impacts on water resources, as well as relevant terminology (Ch. 1). Local context is then integrated to clearly show the unique hydrogeological constraints and policy framework of Southeast Florida (Ch. 2). With the local context as the background, the manual then steps the reader through site planning (Ch. 3), planning for stormwater management (Ch. 4), various types of LID SCMs (Ch. 5), evaluating SCM options (Ch. 6), operation and maintenance (Ch. 7), and evaluating the performance of SCMs (Ch. 8). Successful implementation of the strategies depends on public acceptance, which makes public education (Ch. 9) an important part of the process.

A companion tool, the LID reference matrix, was developed for users to compare and evaluate characteristics and siting of different options. The value of LID and GI within communities extends beyond just LBSP management; the manual highlights the ancillary benefits as well (Ch. 10). The manual closes with conclusions and recommended next steps (Ch. 11) to help the reader implement the various strategies described to reduce LBSP.

To assist with navigating this document, the generalized flow chart on the following page (repeated in Figure 6.2) outlines the basic process for evaluating a site and selecting the most appropriate means to avoid, reduce, or treat pollutants that are common in Florida waters. The chart's elements are linked to the corresponding sections of this report. A few of the final steps, particularly assessing the treatment performance and life cycle costs of SCMs, sizing methodologies, and other design calculations, are not in the scope of this document.

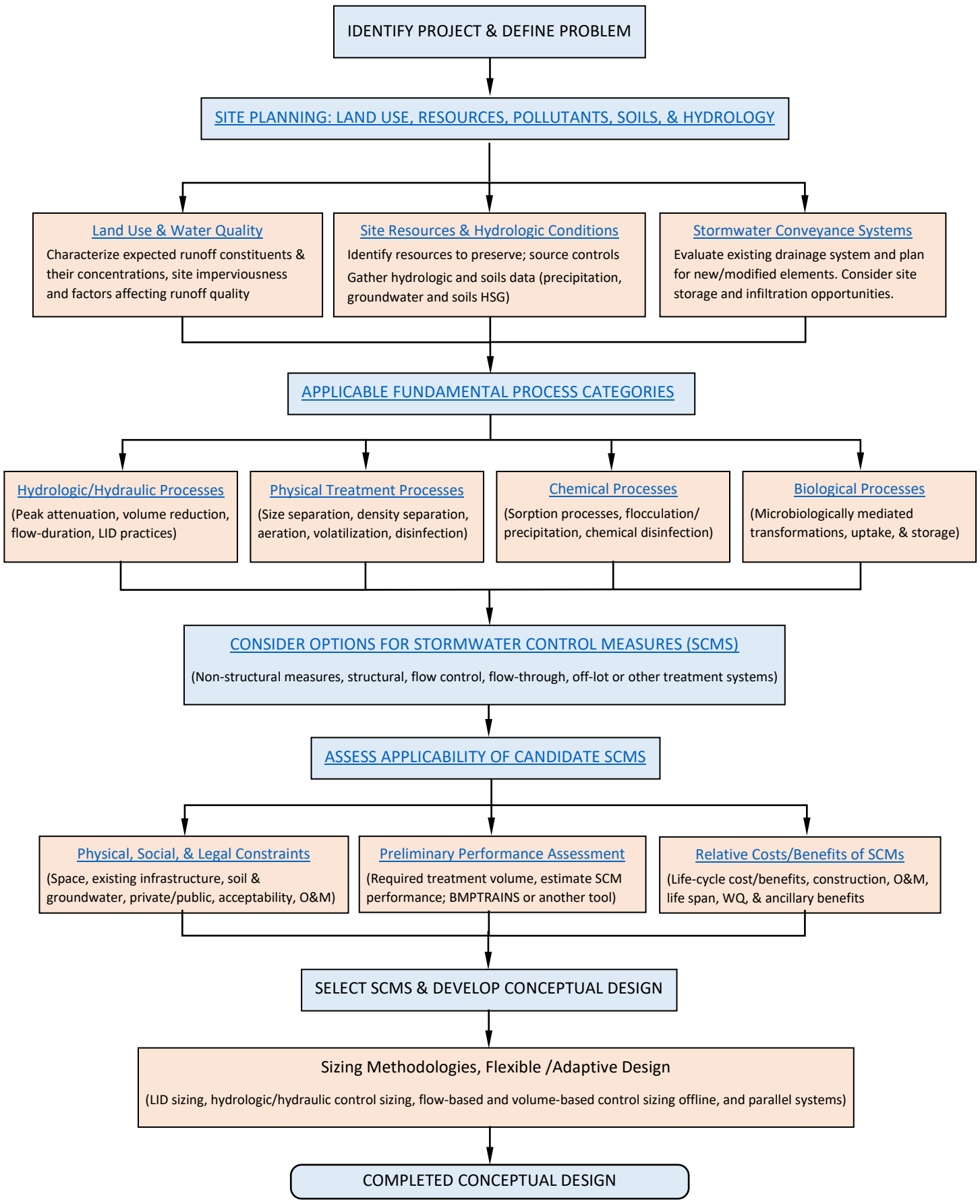

1. INTRODUCTION

The introductory chapter of this manual lays the foundation and provides essential context for understanding why Low Impact Development (LID) and Green Infrastructure (GI) strategies can be effective in addressing the range of challenges stemming from land-based sources of pollution (LBSP) in Southeast Florida. To do so, Chapter 1 addresses the following questions:

1. *What is the purpose of this manual, and who are the intended users?*
2. *What is the manual's scope, and how is it organized?*
3. *How has urbanization of Southeast Florida and land-based sources of pollution affected environmental systems, natural resources, and coral reef ecosystems in the region?*
4. *How is "LID" and "GI" terminology used in the context of and throughout this manual?*
5. *What are the overarching, systemic goals of LID and GI management approaches?*

Key take-home messages include:

- Problems stemming from LBSP—pollutants that cause direct impacts on coral reefs as well as other marine habitats and natural ecosystems—coupled with stressors from climate change (e.g., sea level rise and saltwater intrusion to freshwater aquifers) create significant challenges and a range of opportunities for pollution reduction.
- Costs of these LBSP problems are realized in many ways, some of which are more tangible and resonant among local citizens and decision-makers than others. Acute algal blooms and chronic water quality problems lead to immediate and long-term environmental and economic damages. More frequent and extreme weather events increase flooding risks, exacerbate the “downstream” and long-term effects of impaired aquatic systems, and increase the expenses and investments necessary to reduce pollutant loads and restore water quality. Ultimately, effects of LBSP lead to lost revenue from tourism, recreation, and other sectors of the local and regional economy that depend on natural resources.
- As a response and management approach, conventional stormwater control measures (SCMs) have not adequately addressed the roots of these complex LBSP problems, namely the unintended consequences or side effects of consumer society (nutrient runoff, plastic pollution, personal care products and pharmaceuticals polluting waterways, etc.).
- Alternative solutions do exist at various scales, however, and a holistic and comprehensive design and management approach is necessary to reduce LBSP and address the many problems it generates downstream. At the highest level, this means adopting and implementing prevention, mitigation, treatment, and adaptation strategies that include source controls and stormwater management with LID/GI features.
- This manual provides an overview of potential strategies for reducing and managing LBSP in Southeast Florida; raises awareness of how to identify key LID/GI opportunities and interventions in the process of evaluating a site for development, retrofitting, or redevelopment; introduces and explains a suite of LID/GI SCMs and treatment train approaches; and provides information on potential ancillary benefits of an LID/GI approach.

Coral reefs extend offshore from the St. Lucie Inlet in Martin County around the southern end of the Florida peninsula and westward to the Dry Tortugas. Despite its importance economically and culturally, the northern third of the Florida reef tract has not previously been comprehensively managed and is threatened by many human activities, such as algal blooms spurred by high levels of nutrients, pollutants from storm and wastewater discharges, as well as warmer temperatures and higher acidity due to global climate change. The Southeast Florida Coral Reef Initiative (SEFCRI) is a coalition of government and non-governmental partners working to identify and implement actions to reduce key threats to coral reef resources in Miami-Dade, Broward, Palm Beach, and Martin counties (Figure 1-1). A management plan for this area may be developed in conjunction with the Southeast Florida Coral Reef Ecosystem Conservation Area (ECA). The ECA establishes a boundary around coral reefs and their associated hard bottom areas offshore from the St. Lucie Inlet in Martin County to the northern border of Biscayne National Park in Miami-Dade County.

This document considers land-based sources of pollutants and the most appropriate means of removing them or preventing their entry into coastal waters. Strategies that limit the land-based sources of pollutants from urbanized areas are collectively referred to as LID in this manual.

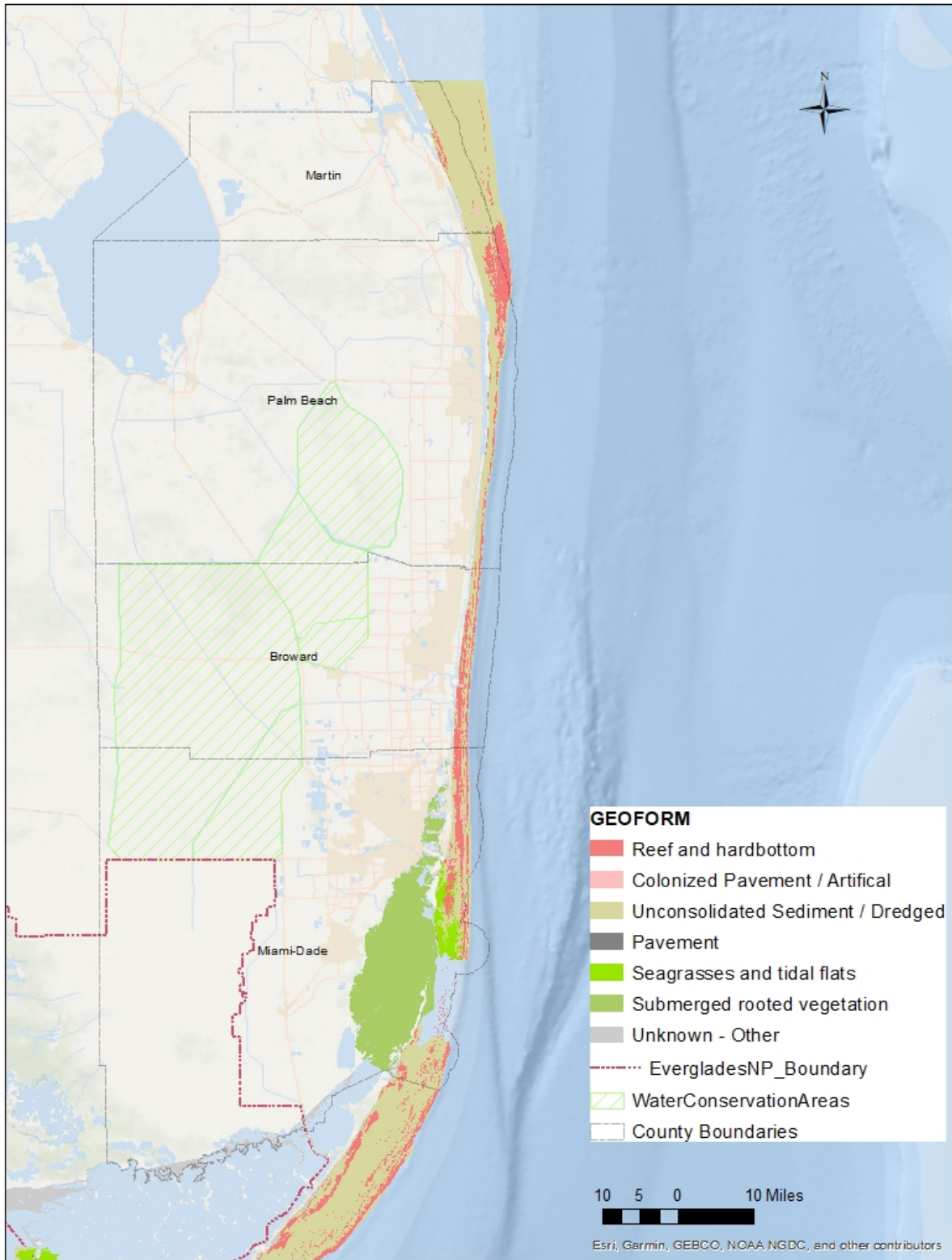

Figure 1-1. Map of coral reefs (northern portion) off Southeast Florida and the counties overseeing them.

1.1. Purpose of Manual and Intended Users

1.1.1. Inform local government officials and design professionals

While many aspects of LID or GI are familiar to local government and design professionals, obtaining the full benefits of these practices may require a subtle change in attitude or in the traditional “way of doing things.” Because initial planning is crucial, this document strives to describe the full range of issues that must be considered and opportunities to address those issues in planning, designing, and constructing communities and redevelopment projects. The hope is that this document will fill information gaps and provide a basis of information for those responsible for planning and approving urban development projects.

1.1.2. Describe environmental changes brought about by development practices and common pollutant reduction approaches

Traditional development practices have significant adverse impacts on hydrology and water quality. Impervious cover, piping, and soil compaction increase the runoff volumes and rates while reducing infiltration and groundwater recharge. This approach efficiently conveys pollutants, such as nutrients, metals, pathogens, and sediments, offsite and into receiving waters. Conventional stormwater management and treatment has focused on “end of pipe” solutions that provide less effective treatment. The changes in water quality and hydrologic functions caused by traditional development are significant and have been shown to be insufficient at sustaining healthy ecosystems downstream. Nutrient levels in surface waters have remained stubbornly high after several decades of standard stormwater sewer collection networks and treatment pond systems. However, seemingly small LID and GI projects can be surprisingly effective tools when used in concert and over full watersheds. They are best applied during initial development, but improvements can be made when they are implemented through retrofit, redevelopment, roadway improvement, or septic to sewer conversion projects.

1.1.3. Provide a framework for incorporating low-impact development principles and techniques by selecting appropriate, more sustainable alternatives

Individual techniques for reducing and treating runoff or using source controls to avert water pollution altogether are described, along with their major mechanisms. A framework is given to aid in choosing the techniques appropriate for projects with varying conditions in Southeast Florida. The selection process is provided through the information in the text, a decision tree chart, and a matrix summarizing benefits and constraints of each practice.

1.1.4. Highlight opportunities to enhance communities as healthy, desirable places and ecosystems within which to live and work

Many LID/GI principles and some stormwater management features have benefits beyond stormwater control and pollution reduction. Preserving natural areas or creating new urban green spaces along with compact development encourage walkable neighborhoods and urban oases. Implementing LID/GI creates local jobs and can increase property values as they improve the quality and usability of surface waters. They work well with other urban design methods to create pleasing, healthy environments and shared spaces that foster stronger communities.

1.2. Manual Organization

This manual is organized into 11 chapters:

- Chapter 1 introduces the hydrologic and water quality changes commonly created by urban development and their impacts on natural habitats, the inadequacies of conventional stormwater management, and the goals of LID.
- Chapter 2 describes the local physical environment and policy framework related to LID and GI.
- Chapter 3 describes the process of initial site planning and assessing suitability for LID/GI SCM applications.
- Chapter 4 covers planning for stormwater management, including conveyance and storage, treatment processes (physical, chemical, biological, etc.), and planning a treatment train.
- Chapter 5 describes specific LID/GI Stormwater Control Measures and discusses their benefits, constraints, and basic design considerations.
- Chapter 6 describes the process of evaluating various SCM options.
- Chapter 7 discusses the operation and maintenance activities that are necessary for continued functioning of SCMs.
- Chapter 8 covers the means to verify continued SCMs performance.
- Chapter 9 describes the various aspects of public education relating to the implementation of LID and GI.
- Chapter 10 provides information on the ancillary benefits of LID and GI to the local community.
- Chapter 11 closes the manual and offers recommended next steps for implementing LID and GI.

1.3. Impacts of Urbanization on the Environment

1.3.1. Hydrologic changes and effects

Urbanization usually drives large-scale changes to natural environments beyond the obvious change in land use. Altered topography and rerouting drainage paths, from small ditches to canals, streams, and rivers, have made major changes to the route stormwater takes as it drains to the ocean. Changes in impervious areas reduce the amount of water soaking into the ground and recharging aquifers, and excess chemicals applied to our landscapes or that spill onto paved areas are carried into water bodies.

EROSION AND DEPOSITION

Impervious areas from buildings, roads, and hardscape prevent infiltration of rainwater, increasing the amount of runoff and the speed it travels. Conventional stormwater management practices concentrate the flow quickly into piped systems, efficiently moving water offsite. Increases in both peak and total volume of runoff contribute to erosion in receiving streams. Sediment picked up by higher, faster-moving water will eventually be deposited downstream in canals, streams, estuaries, or along shorelines, where it can bury plants and other organisms. The remaining suspended sediment clouds the water, reducing sunlight that is important for healthy aquatic ecosystems.

IMPACT ON FRESHWATER ECOSYSTEMS FROM CHANGED CANAL FLOW REGIMES AND WETLAND HYDROPERIODS

The impacts described above are partially alleviated by stormwater ponds, which are common in Florida suburban development. Although ponds typically slow and detain runoff, thereby removing sediment and reducing peak runoff rates, development allows water to drain offsite into canals more quickly and often reduces the hydroperiods of wetlands. A larger total volume of runoff enters estuaries, decreasing their salinity. Some infiltration into groundwater occurs in many stormwater ponds, but the amount is usually reduced from pre-development conditions. Historically, dense urban areas have been unlikely to provide significant stormwater detention/retention or infiltration, allowing large increases in stormwater volume and flow rates. Current regulations provide a partial remedy by requiring all new development to retain or detain runoff from a 10-year, 3-day storm event. Canals draining Lake Okeechobee and other interior areas through the canal system also increase freshwater flows to estuaries, changing water salinity and chemistry.

INCREASED NUTRIENT LOADS AND THEIR EFFECT ON RED TIDES, MANGROVES, SEAGRASS, FISH, AND CORAL REEFS

Estuaries and coastal ecosystems provide many important benefits, from providing nurseries for numerous fish species, birds, and other wildlife, to protecting shorelines from erosion by absorbing and dissipating wave energy. Heavy nutrient loads, specifically nitrogen (N) and phosphorus (P) carried by stormwater runoff, act to feed phytoplankton, causing or contributing to harmful algal blooms (HAB). These consist of macro or micro algae and cyanobacteria and are commonly referred to as red, brown, or green tides. They can kill plant and animal life in sea grass, coral reef, and mangrove habitats, accelerating eutrophication and dead zones in once-productive marine and estuarine areas.

A severe “superbloom” of algae/phytoplankton that began in the Indian River Lagoon in the spring of 2011 and lasted into 2012 is an example of the harm that can be caused by excessive nutrients. The bloom resulted in the loss of 47,000 acres (60%) of seagrasses in the Lagoon. Because seagrasses are such important habitats for countless marine species, a loss of this magnitude would have lasting consequences for the health of the Lagoon and offshore marine areas. Onsite wastewater treatment (septic tanks and drainfields) were determined to be a major source of N fueling this particular bloom.¹ Other sources of nutrients include fertilizers applied to urban landscapes and agricultural areas, as well as point sources such as wastewater treatment plants. Water diverted in canals from Lake Okeechobee and other agricultural areas also adds to nutrient loads in coastal waters. Specific watersheds should be considered on a case-by-case basis for the relative N and P contributions from each source and evaluated for the potential to reduce nutrient discharges into surface and groundwater. No single action is likely to be sufficient; it is not enough to reduce any one nutrient source, as all must be addressed.

Although excess nutrients are contributing to increased toxic algal blooms, sediment carried in urban stormwater increases turbidity and can also bury seagrass and coral. Other contaminants in stormwater or wastewater plant discharges can be toxic to aquatic organisms. These include heavy metals in stormwater and pharmaceuticals and sunscreen chemicals, such as oxybenzone and octinoxate, in wastewater effluent.

¹ Lapointe, B. E., Herren, L. W., Debortoli, D. D., & Vogel, M. A. (2015, March). Evidence of sewage-driven eutrophication and harmful algal blooms in Florida’s Indian River Lagoon. *Harmful Algae*, 43, 82–102. <https://doi.org/10.1016/j.hal.2015.01.004>

NATURAL HYDROLOGY, INFILTRATION

As much as possible, replicating the original site hydrology is a primary design goal of LID to prevent erosion and flooding, maintain or increase wetland hydroperiods, and preserve aquatic ecosystems. Components of the original hydrology include the predevelopment volumes and rates of surface water runoff, infiltration, and evapotranspiration. Urban development will always modify several or all of these, often to the detriment of natural systems, unless specific measures are implemented to mitigate the changes.

Increased runoff from pervious vs. impervious areas is an obvious impact from human development. The terms “pervious” and “impervious” refer to the ability of a surface material to allow water to pass through into the ground below. Soils are a major factor in the runoff produced by pervious areas. Sandy soils are much more pervious than those containing clay and yield less runoff than clays. The depth to the water table can also affect runoff produced from pervious areas by reducing the volume available for infiltration in soils.

POLLUTANT LOADS: VOLUME-DEPENDENT AND CONCENTRATION-DEPENDENT

The total amount (mass load) of a pollutant in the environment is determined by both its concentration in water and the amount of water. Reducing the volume of runoff with infiltration is a simple way of reducing nutrient loads, where that is possible. However, in areas with high groundwater tables, stormwater treatment with filtration may be an option if high concentrations of nutrients or other pollutants are present in runoff.

GROUNDWATER: IMPACT OF REDUCED RECHARGE FROM INFILTRATION AND INCREASED POTABLE USE

As larger portions of rain fall on impervious surfaces and are carried away by surface drainage, less rainfall soaks into the ground to recharge aquifers. Growing urban areas also require more potable water for larger populations, and as most Floridians rely on groundwater sources, the aquifers are further depleted. Decreased infiltration in coastal areas, like Southeast Florida, reduces the amount of fresh water recharge to aquifers and lowers groundwater levels in water supply wells. This human-induced saltwater intrusion is magnified by sea level rise. The U.S. Geological Survey has data for 31 groundwater monitoring wells in the Biscayne and surficial aquifers in Southeast Florida, allowing historic trends to be observed. The data is available on the [National Ground-Water Monitoring Network](#).

1.3.2. Water quality changes and effects

Urban contaminants carried by stormwater can negatively impact water quality and aquatic ecosystems. Some substances typically enter water bodies from domestic wastewater effluent, but they may also end up in stormwater from onsite (septic) wastewater systems or leaking or flooded wastewater collection pipes and manholes.

NUTRIENTS

Nitrogen and phosphorus occur naturally from decaying organic material on land and in lakes and rivers and are deposited from atmospheric processes. Estuaries are typically nitrogen limited, while inland fresh water is often phosphorus limited. This means that algae and aquatic vegetation growth are kept in check by the amount of available nutrients. When higher levels of these nutrients occur in surface waters, their growth increases. Additional nutrients are carried by runoff from urban and agricultural areas, as well as loadings from septic systems. Excess nutrients encourage the growth of cyanobacteria blooms in fresh water and “red tides” in sea water caused by a marine alga, *Karenia brevis*, which produces a neurotoxin

capable of killing most sea life. Huge numbers of fish, sea mammals, and birds were killed by the 2018 red tide that stretched more than 145 miles along Florida's southwest coast. The red tide also closed beaches on the Southeast coast of Florida in 2018, a previously unheard-of event. Recorded human health effects worldwide include respiratory irritation from airborne toxins and allergic reactions (rashes) from contact with the water to gastrointestinal problems and poisonings, which can be acute or chronic and lethal.² Economic losses to tourism and other businesses are also serious consequences of algal blooms. Although algal blooms can occur with naturally occurring nutrients, higher concentrations and warmer temperatures both add to the frequency, severity, and duration of these phenomena. Based on two sets of data on algal concentrations, average levels of red tide are now 15 times higher than they were 50 years ago (2018 vs. 1968).³

PATHOGENS: WILDLIFE, PET WASTES, FLOODED SEWER SYSTEM (WASTEWATER)

Bacteria are ubiquitous in all environments, but fecal indicator bacteria (FIB), such as fecal coliform, *Escherichia coli* (*E. coli*), or enterococci bacteria, which are found naturally in human and animal fecal matter, are used to assess whether water is contaminated. Their presence signals that other pathogenic bacteria and viruses may also be present. Stormwater can transport pathogens from pet waste, animal farming, or from flooded or overflowing municipal wastewater pipes and manholes into receiving waters. However, wildlife waste is a natural source, and low background levels of FIB contamination can persist in watersheds, making source identification and control more difficult.⁴

HEAVY METALS: ROADWAYS, INDUSTRIAL FACILITIES, CAR WASHING

Heavy metals such as chromium, nickel, copper, zinc, cadmium, and lead are residuals from combustion of petroleum products and the breakdown of vehicle and roadway materials. These are introduced into stormwater from roadways, industrial facilities, and car wash facilities. Some metals can also be leached from roofing materials, particularly zinc from galvanized gutters and downspouts. Dissolved forms of metals are difficult to remove, but they are found more often as particulates and can be removed (in varying degrees) by sedimentation and/or filtration. Filtration can occur either naturally as water flows through soil or in stormwater treatment systems, including rain gardens, tree box filters, vegetated swales, or infiltration trenches. Temperature, pH, the presence of organic material, and the oxidation-reduction potential also affect their treatability for metals.⁵

PESTICIDES AND OTHER URBAN CHEMICALS

Other pollutants can also be found in stormwater runoff, including pesticides (fungicides, algacides, herbicides, and insecticides) used on residential and agricultural land. Some residents might use storm

² Carmichael, W. W., & Boyer, G. L. (2016). Health impacts from cyanobacteria harmful algae blooms: Implications for the North American Great Lakes. *Harmful Algae*, 54, 194–212. <https://doi.org/10.1016/j.hal.2016.02.002>

³ Armistead, T. F. (2018, September 5). Florida project could help address runoff, algae blooms. Retrieved from <https://www.enr.com/articles/45102-florida-project-could-help-address-runoff-algae-blooms>

⁴ Clary, J., Pitt, R., & Steets, B. (Eds.). (2014). *Pathogens in urban stormwater systems*. Environmental and Water Resources Institute, American Society of Civil Engineers. Retrieved from <http://www.asce-pgh.org/Resources/EWRI/Pathogens%20Paper%20August%202014.pdf>

⁵ Pitt, R., & Ogburn, O. (2013). *Contributions of heavy metals from material exposures to stormwater*. Retrieved from http://rpitt.eng.ua.edu/Publications/4_Stormwater_Characteristics_Pollutant_Sources_and_Land_Development_Characteristics/Stormwater_pollutant_sources/Contributions_of_Heavy_Metals_from_Material_Exposures_to_Stormwater.pdf

inlets to dispose of chemicals, such as paints and used motor oil. These would be carried into and through drainage systems by the next rainfall.

POLYCYCLIC AROMATIC HYDROCARBONS

Polycyclic aromatic hydrocarbons (PAHs) are a group of persistent organic compounds, seven of which are designated by the U.S. EPA as probable human carcinogens and toxic to fish and other aquatic life. They are produced naturally in small amounts by wildfires, decomposition of some biological material, and fossil fuels. Anthropogenic sources include incomplete combustion of organic substances (wood, gasoline, coal, etc.) and automobile tires, but the vast majority of PAHs found in stormwater sediments are from coal-tar-based pavement sealants primarily used on parking lots and driveways. These materials contain high level of PAHs, which are gradually worn away by abrasion and weather and are released at levels hundreds to thousands of times greater than levels from other sources (Figure 1-2).



Figure 1-2 PAHs from coal-tar-based pavement sealants. Dried sealcoat products (A), gradually abrade to a powder and become part of the dust on the pavement (B). Pavement dust is transported by rainfall runoff (C) to stormwater management devices (D) or to receiving streams and lakes (E). Pavement dust also adheres to tires (F) that track it onto unsealed pavement, and wind and runoff transport the dust to nearby soils (G). Sealcoat particles tracked into residences can become incorporated into the house dust (H). Graphic from [USGS Fact Sheet 2016-3017](#).

Numerous municipalities and several states have banned coal-tar sealants, and major retail chains have stopped selling them. Equally effective, low-polluting asphalt-based sealants are available; however, some coal-tar sealants are still in use. If they are present in a watershed, the design of the receiving stormwater SCMs should allow sediment to settle (perhaps in a pond forebay or a sediment-removing baffle box) upstream of the treatment area, and sediment should be regularly removed as it accumulates.⁶ Florida regulates some PAHs under Chapter 62-780, F.A.C., Contaminated Site Cleanup

⁶ Mahler, B. J., & Van Metre, P. C. (2011). *Coal-Tar-Based Pavement Sealcoat, Polycyclic Aromatic Hydrocarbons (PAHs), and Environmental Health (Fact Sheet No. U.S. Geological Survey Fact Sheet 2011-3010)*. U.S. Geological

Criteria, which “applies to site rehabilitation conducted at sites contaminated with pollutants, hazardous substances, dry-cleaning solvents, petroleum and petroleum products.”⁷

SUNSCREENS (OXYBENZONE, OCTINOXATE)

Chemicals common in sunscreens can be found in wastewater effluent and have been implicated in increased coral bleaching and the declining health of marine ecosystems. In July 2018, Hawaii enacted a ban on sunscreens containing oxybenzone and octinoxate. Although conclusive evidence implicating specific chemicals is not yet available, coastal communities should be aware of the problem and its potential effects of compounds on coastal environments. They should promote public awareness of safer sunscreen options as they are developed if sufficient research supports alternative sunscreens. Additional research is needed to evaluate the effects of sunscreens that are currently being marketed as safe for coral. Options include mineral sunscreens containing zinc and titanium, which may be less toxic unless they are in the form of nanoparticles. One non-toxic sunscreen that researchers at the University of Florida are working on is made from shinorine, a compound produced by algae.⁸ Sun-protective clothing and hats are another option capable of providing superior sun protection without chemical sunscreens.

PHARMACEUTICALS AND PERSONAL CARE PRODUCTS

Although water quality standards in Florida do not address pharmaceutical or personal care products, those products are increasingly being found in surface water and aquatic organisms and are termed “contaminants of emerging concern” (CEC) by the EPA. Concern is growing that CECs may be bioactive, as data are showing that trace amounts of pharmaceuticals and personal care products are found in many different locations in watersheds, estuaries, and the coral reef ecosystem.

In 2006, an EPA investigation of pharmaceuticals in fish tested for 24 different drugs at five locations near wastewater treatment plants across the U.S. and one reference site in a pristine location. They found seven pharmaceuticals in the livers of fish at all five affected sites, and five of the compounds were also found in fillets from the fish. Anti-depressants were found in fish at all the sites, and an antihistamine was present at all but one location. Of the personal care products tested for, two fragrances were found in fish at all five sites.⁹

Other studies have found compounds as diverse as steroidal estrogens and other hormones, caffeine, and DEET in U.S. coastal waters, including south Florida.^{10, 11} Corals have been shown to suffer reduced

Survey. Retrieved from <https://pubs.usgs.gov/fs/2011/3010/pdf/fs2011-3010.pdf>

⁷ State of Florida. (2017, February). Changes to all sections of Chapter 62-780, F.A.C., Contaminated Site Cleanup Criteria, in order to merge Chapters 62-770 (Petroleum Contamination Site Cleanup Criteria), 62-782 (Drycleaning Solvent Cleanup Criteria), and 62-785. *Florida Administrative Register*, 38(36). Retrieved from <http://flrules.elaws.us/fac/62-780.150>

⁸ Treviño, J. (2018, July 16). Can we create sunscreen that protects both humans and coral reefs? *Smithsonian Magazine*. Retrieved from <https://www.smithsonianmag.com/science/scientists-are-unraveling-new-dangers-sunscreen-coral-reefs-180969627/>

⁹ EPA. (2016, January 20). Pilot study of pharmaceuticals and personal care products in fish tissue [Overviews and Factsheets]. [Online report]. Retrieved from <https://www.epa.gov/fish-tech/pilot-study-pharmaceuticals-and-personal-care-products-fish-tissue>

¹⁰ Atkinson, S., Atkinson, M., & Tarrant, A. (2003). Estrogens from sewage in coastal marine environments. *Environmental Health Perspectives*, 111, 1-7

¹¹ Singh, S. P., Azua, A., Chaudhary, A., Khan, S., Willett, K. L., & Gardinali, P.R. (2009). Occurrence and distribution of steroids, hormones and selected pharmaceuticals in South Florida coastal environments. *Ecotoxicology*, 19, 338350.

growth and reproductive capacity from exposure to estrogens.¹² The impacts of low levels of these compounds on fish, amphibians, and other aquatic organisms, or on humans who consume them, are largely unknown. Research into the effectiveness of wastewater treatment processes has indicated that a series of different processes employing biologic, hydrodynamic, and advanced oxidative methods, can provide almost complete removal of many pharmaceuticals.¹³ However, most existing wastewater treatment plants and onsite septic systems do not employ all of these processes. More research and process changes at wastewater treatment plants are needed to ensure the effective removal of pharmaceutical compounds.

PLASTICS AND TRASH

Household trash and roadside litter degrade water quality in receiving streams. Plastics are a particular problem, as they make up more than 90% of persistent marine debris and are considered to be a major threat to biodiversity from entanglement and ingestion by many species of seabirds, marine mammals, turtles, and fish.¹⁴ The effects on sea birds, turtles, and mammals from entanglement with macro plastics, such as fishing lines or plastic packaging on beverage 6-packs, are relatively well-known, but microplastics (particles less than 5mm in size) have also emerged as a significant threat to marine fauna. Microplastics may be manufactured and used in various industrial and consumer products, or they may be formed by the breakdown of discarded plastic bags, bottles, packaging, and a host of other products. They are being found at alarming quantities in fresh and marine waters, in the soil and in our food supply where they persist for long time periods. Aquatic species such as fish and coral¹⁵ have been found to ingest tiny particles, and they can bioaccumulate in species higher on the food chain. Microplastics can have various physical and chemical effects on the organisms that ingest them. Some lead to blockages in the animal's intestinal tract, inhibit feeding behavior, or interfere with reproduction systems. The full effects of plastic exposure on many species are only beginning to be understood.¹⁶ Microplastics can also carry heavy metals or other pollutants that adsorb to them, creating another hazard for the aquatic life that consume them.¹⁷

ORGANIC DEBRIS

Objects such as tree branches, fallen leaves, and grass clippings may not appear to pose a problem for water quality, as they may be considered “natural” parts of the environment. While not strictly defined as pollutants, they are carried by stormwater into streams and coastal waters and provide another

Retrieved from <https://www.ncbi.nlm.nih.gov/pubmed/19779818>

¹² Wear, S. L., & Thurber, R. V. (2015). Sewage pollution: mitigation is key for coral reef stewardship. *Annals of the New York Academy of Sciences*, 1355(1), 15–30. <https://doi.org/10.1111/nyas.12785>

¹³ Zupanc, M., Kosjek, T., Petkovšek, M., Dular, M., Kompare, B., Širok, B., Heath, E. (2013). Removal of pharmaceuticals from wastewater by biological processes, hydrodynamic cavitation and UV treatment. *Ultrasonics Sonochemistry*, 20(4), 1104–1112. <https://doi.org/10.1016/j.ultsonch.2012.12.003>

¹⁴ Gall, S. C., & Thompson, R. C. (2015). The impact of debris on marine life. *Marine Pollution Bulletin*, 92(1–2), 170–179. <https://doi.org/10.1016/j.marpolbul.2014.12.041>

¹⁵ Allen, A. S., Seymour, A. C., & Rittschof, D. (2017). Chemoreception drives plastic consumption in a hard coral. *Marine pollution bulletin*, 124(1), 198–205.

¹⁶ Li, W.C., Tse, H.F., Fok, L. (2016). Plastic waste in the marine environment: A review of sources, occurrence and effects. *Science of The Total Environment*, (566–567), 333–349. <https://doi.org/10.1016/j.scitotenv.2016.05.084>

¹⁷ Hall, N. M., Berry, K. L. E., Rintoul, L., & Hoogenboom, M. O. (2015). Microplastic ingestion by scleractinian corals. *Marine Biology*. <https://doi.org/10.1007/s00227-015-2619-7>

source of nutrients for algae and other microorganisms. Grass clippings are a particular problem, as they are often blown into storm drains by residents or landscaping crews.

Microorganisms require dissolved oxygen in water in order to decompose organic matter. A problem may develop, however, when other aquatic life compete for the same dissolved oxygen, as it can be depleted to levels that are harmful or fatal to other aquatic life. When this happens, dead zones are created in estuaries, along coast lines and near mouths of rivers. The number and size of dead zones have increased dramatically in recent decades. Although dead zones have been less pronounced in Southeast Florida than on its southwest coast, dead fish and other aquatic life have been observed, and the potential for worsening conditions remains.

1.3.3. Conventional approaches to stormwater management and pollutant reduction

Historically, stormwater has been viewed through the lens of flood control and has been efficiently collected and drained away from developed areas. Removing pollutants in stormwater became a secondary goal as society recognized the need to protect downstream habitats. To improve Florida's water quality, stormwater has typically been treated in detention or retention ponds. Over the last few decades, it has become clear that more needed to be done as water quality goals have not been achieved. Other treatment options are possible and, when used in combination, can effectively remove pollutants. These treatments are described in Chapters 4 and 5.

In addition to the need for improved stormwater treatment, the demand for potable water to serve growing populations has put pressure on aquifers, lowering their levels to below historic levels and reducing the flow at many of Florida's famous freshwater springs. Stormwater reuse, also called rainwater harvesting, is one approach to satisfy a portion of our urban water needs. In some parts of the world, rainwater is collected for household use, but U.S. regulations restrict or prohibit this practice. Constructing greywater systems in new homes or providing storage for outdoor irrigation supplied by rainfall or runoff are a couple of options for stormwater reuse.

1.3.4. Legacy effects of stormwater management and pollutant reduction

The legacy of decades of moving stormwater offsite is a network of stormwater collection infrastructure that is poorly adapted to sustain the natural hydrology of habitats in Southeast Florida. Infiltration to groundwater is greatly reduced, stream banks and beds can be scoured in some places, and areas with less slope downstream are buried in deposited silt. A lack of regulatory mandates or funding to correct these problems mean that they will continue into the foreseeable future.

Stormwater detention ponds do address the worst of these effects by removing sediment and pollutants that often adhere to soil particles and slowing the flow of water into receiving water bodies. Stormwater detention ponds are largely ineffective at removing dissolved nitrogen and phosphorus from stormwater. The total volume of fresh water running off the land usually remains larger than under natural conditions. The cumulative effect of this discharge into coastal waters can decrease salinity and adversely affect estuarine and marine habitats.

1.4. Terminology in Practice

In the early 1990s, the term Low Impact Development (LID) was coined by Larry Coffman (widely recognized as the innovator of urban LID design), prompting popular and widespread use of the term LID

as an urban stormwater management approach. More recently, the term Green Infrastructure (GI) has gained widespread usage, with often-overlapping meanings for both terminologies. LID can be thought of as the planning and design of communities to maintain pre-development hydrology and natural habitats where possible by mimicking natural processes. GI may indicate the physical stormwater control measures or infrastructure used to achieve the LID goals.

A more expansive interpretation of LID extends to other areas as a focus to lessen society's impact on all-natural systems and to promote sustainable communities. This interpretation of LID overlaps with the terms "smart development" or "new-urbanism." Stormwater and water quality are components of a comprehensive analysis of urban design that may include subjects as diverse as planning for mixed use buildings, walkable communities, multi-modal transportation, urban forests, local food systems, and improved health for urban residents. Overall, LID stormwater management goals are compatible with and support these other aspects of urban design. This document focuses on issues that impact water quality, with the understanding that planning and designing these LID features are often part of a larger plan for urban environments.

Stormwater management using LID/GI focuses on transforming conventional design, infrastructure, and management to address the dual goals of flood control and water quality protection. Successful adoption of LID practice requires a fundamental shift in thinking from the traditional "collect, concentrate, convey, centralize and control" approach to a new stormwater management mantra of "slow it, spread it, and sink it." The emphasis is on slowing runoff so that infiltration can occur. Vegetation can provide distributed treatment rather than rapidly collecting runoff to be treated in large central stormwater ponds.

A functional definition of LID is: *"A site design strategy for maintaining or replicating the predevelopment hydrologic regime through the use of design techniques that create a functionally equivalent hydrologic landscape. Hydrologic functions of storage, infiltration, and groundwater recharge, plus discharge volume and frequency are maintained by integrated and distributed microscale stormwater retention and detention areas, reduction of impervious surfaces, and the lengthening of flow paths and runoff time. Other LID strategies include, but are not limited to, the preservation of environmentally sensitive site features such as natural upland habitat, wetlands, wetland buffers, and floodplains."*¹⁸ Inclusion of riparian buffers along stormwater conveyance features, where feasible, is also recommended.

1.5. Goals of Low Impact Development

The LID stormwater management approach inventories and manages pre-development site attributes (rainfall, soils, vegetation, topography, etc.) as assets and opportunities rather than as liabilities and obstacles. This approach includes strategies at both the development/subdivision/catchment scale and the lot/parcel scale.¹⁹

At the conceptual planning stage, a site inventory should be made to identify surface and sub-surface drainage features, soil types, depth to groundwater, and any natural vegetation that may be retained.

¹⁸ Alachua County Unified Land Development Code 410-23.

¹⁹ UF PREC, Alachua County Draft LID Manual.

1.5.1. Maintain natural site hydrology and topography

Predevelopment topography should drive a project's stormwater design rather than alter the topography of the site during development to fit a traditional stormwater management plan. Projects should use the topographic characteristics of the site to guide the road layout and stormwater conveyance features while also considering the natural drainage when delineating lots and placing public infrastructure. Topographic features should also guide lot-level landscape layout and plantings. For instance, avoid re-contouring and installing high-maintenance landscaping or turf or disturbing areas with steep slopes or natural landscape depressions that should be preserved for their infiltration capacity (Figure 1-3). Natural depressions should be maintained where possible to promote storage, infiltration, and treatment during typical stormwater events and to capture the "first flush" of stormwater during extreme events. "First flush" refers to the earliest runoff that occurs after a dry period. It often contains a higher concentration of pollutants than runoff that comes later, and it is a good practice to capture and treat this initial runoff.

1.5.2. Protect aquifers

CONTAMINANTS IN STORMWATER

Much of Southeast Florida depends upon the surficial Biscayne aquifer as the major source of potable water for the region,²⁰ and protecting the quality of this water resource is a high priority. However, in areas where confining impervious layers are not present, aquifers are subject to contamination from any pollutants that may be on the land or washed off urban buildings and pavements, such as pathogens, insecticides, herbicides, hydrocarbons, metals, or other substances carried by stormwater.

The LID reference matrix can be used to screen for appropriate stormwater control measures (SCMs) to protect aquifers in high aquifer recharge areas. Infiltration-based SCMs such as bioretention and permeable pavement systems should always be considered, but high water tables constrain their design in many locations. For projects in wellfield protection areas or those where spills of hazardous materials

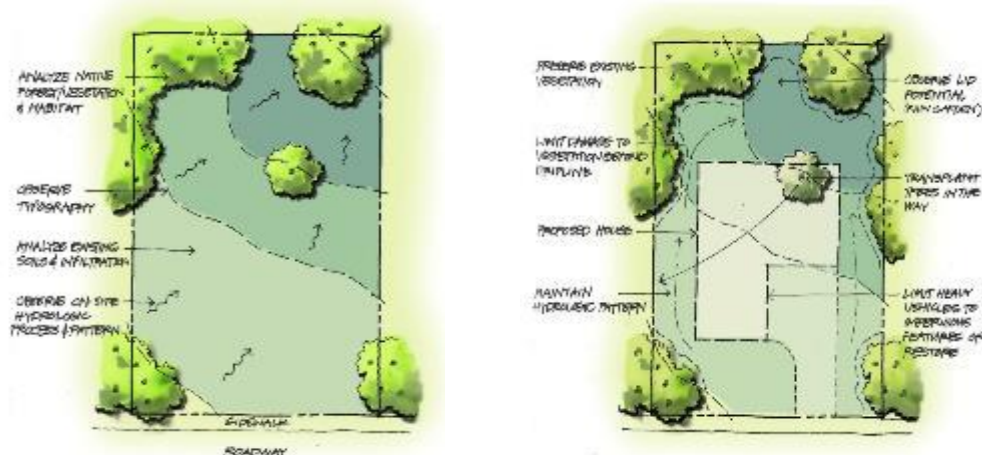

²⁰ Williams, L. J., & Kuniandy, E. L. (2016). *Revised hydrogeologic framework of the Floridan aquifer system in Florida and parts of Georgia, Alabama, and South Carolina*. U.S. Geological Survey. <http://dx.doi.org/10.3133/pp1807>

are possible, source control of stormwater pollutant loads are an especially important consideration, and appropriate treatment best management practices (BMPs) must be designed to avoid inadvertent transfer of contaminants from surface water to groundwater.

SALTWATER INTRUSION

In coastal areas, aquifers are also at risk from saltwater intrusion, which becomes increasingly likely as larger volumes of water are withdrawn to serve growing human populations and as rising seas apply greater pressure, forcing salt water further inland. A June 2018 study²¹ based on integrated surface and groundwater modeling of Miami-Dade and Broward counties projected levels of saltwater intrusion into currently potable water sources by 2040. While wells in Miami-Dade are not expected to be adversely affected by rising salinity in this timeframe, many Broward County wells were projected to be impacted assuming a moderate rate of sea-level rise (SLR).²² Other counties in Southeast Florida may face similar saltwater intrusion.

Stormwater reuse and greater infiltration can partially ameliorate the rate of saltwater intrusion by reducing the need for withdrawals from surficial aquifers. Injection wells can also pump excess surface runoff underground to create a buffer between high-quality groundwater and encroaching brackish water.

Local depths to groundwater can be expected to vary with climate change, either decreasing or increasing from higher or lower precipitation amounts, though generally decreasing in coastal areas as saltwater intrudes from SLR. Some areas may see wet season groundwater levels rise by more than two feet under moderate SLR scenarios, including low-lying areas away from the coast. These factors should be considered for individual sites when infiltration SCMs are being planned.

1.5.3. Protect sensitive natural areas and preserve predevelopment hydrology

LID seeks to preserve sensitive natural areas containing significant upland habitats or wetlands by identifying them at the conceptual planning stage and placing developed areas away from them as much as possible. This approach supports preservation of the natural site hydrology and stormwater flow paths. Minimize urban footprint: roads, buildings, and associated infrastructure.

1.5.4. Minimize urban footprint: roads, buildings, associated infrastructure

To reduce the impervious footprint of a development and site disturbance, multi-story building design options are encouraged (i.e., build vertically). Buildings with more than one story maximize the ratio of square footage to roof area and lessen the stormwater runoff from the site.

Selective site clearing and grading is another way to minimize urban footprints. If the clearing, grading, and construction areas are clearly delineated on the ground and all construction personnel are instructed on the purpose and importance of those areas, then soil compaction over the entire site can be confined

²¹ Groves, D. G., Knopman, D., Berg, N., Bond, C. A., Syme, J., & Lempert, R. J. (2018). *Adapting Land Use and Water Management Plans to a Changing Climate in Miami-Dade and Broward Counties, Florida* (Product Page No. RR-1932-MCF) (p. 112). RAND Corporation. Retrieved from https://www.rand.org/pubs/research_reports/RR1932.html

²² Groves, D. G., Knopman, D., Berg, N., Bond, C. A., Syme, J., & Lempert, R. J. (2018). *Adapting Land Use and Water Management Plans to a Changing Climate in Miami-Dade and Broward Counties, Florida* (Product Page No. RR-1932-MCF) (p. 112). RAND Corporation. Retrieved from https://www.rand.org/pubs/research_reports/RR1932.html

to portions of the site, and undisturbed soils can retain their ability to infiltrate stormwater. Existing roads, future road areas, or previously compacted areas can be used for materials staging.

1.5.5. Treat stormwater to remove sediment, excessive nutrients, and other pollutants

Early in the planning process, an evaluation of the expected characteristics of stormwater runoff from the site is needed. To ensure that proper treatments are implemented, it is important to understand what pollutants are likely to be in the stormwater, the processes needed to remove them, and the BMPs available to provide those processes. The most common pollutants in stormwater are sediment, nutrients (nitrogen and phosphorus), heavy metals (zinc, nickel, lead, chromium, cadmium, and copper), pathogens, pesticides, and organic pollutants (gasoline and oils).

Excess nutrients are the focus of treatment from all disturbed land, particularly from managed, landscaped areas, whether they are in new or existing developments. Nutrients are applied to our lawns and public landscaped spaces as fertilizers and are contained in all organic material. When reclaimed wastewater or harvested rainwater is used for irrigation, additional nutrients are being applied. However, property owners may not realize that fertilizer applications should be reduced to compensate for these additional nutrients, as dissolved nutrients are not effectively removed by conventional stormwater treatment.

Source controls to prevent erosion are the easiest and least expensive methods of managing sediment in stormwater. Erosion prevention is required during all construction projects but is not always effectively managed. Post-construction, private property owners may not notice erosion or may have little experience in preventing it. However, the function of many LID measures is impaired by excessive sediment. Treatment system designs that use infiltration or filtration require sediment removal before the water enters that part of the treatment process. Good erosion prevention allows for optimal system performance.

1.5.6. Change overall management and design perspectives

As discussed in Section 1.3.3, society's attitude toward stormwater has historically been to remove it as quickly as possible, discharging it to the nearest stream or body of water. Straight, uniform manmade channels were efficient and effective for removing water from a particular site or area, but more rapid, concentrated flows often created flooding problems downstream, and water quality was not a particular concern. Faster moving flows carry more sediment, which are then deposited in downstream lakes, canals, or estuaries. Removing pollutants in stormwater became a secondary goal as society recognized the need to protect downstream habitats. To improve water quality, developers in Florida have typically treated stormwater in detention or retention ponds. Over the last few decades, however, it has become clear that more treatment is needed as many water quality goals have not been achieved. Other treatment options are possible and are often used in combination to improve pollutant removal.

2. LOCAL ENVIRONMENTAL CONTEXT

Chapter 2 details the local context within which LID and GI opportunities are being evaluated, addressing the following questions:

1. *What are the hydrologic and geologic characteristics of the region, and how do they influence the options for management of land-based sources of pollution?*
2. *What are the unique challenges and constraints affecting the feasibility, success, and cost-effectiveness of LID and GI practices?*
3. *What is the regulatory framework—at the federal, state, and regional levels—within which local decisions about LID and GI must be made?*
4. *Are there examples of LID and GI practices being implemented in Southeast Florida?*

Key take-home messages include:

- Historical flood control approaches in Florida, while successful in conveying stormwater away from property and infrastructure and reducing flood risks, have involved a dramatic transformation of the region away from its natural hydrology and systems of lakes, rivers, streams, estuaries, and riparian zones to engineered linear canal systems that serve as the primary collection and conveyance mechanisms for LBSP.
- Along with rapid population growth and urbanization in Southeast Florida, pollutant loads from land use changes and other anthropogenic sources have increased in both concentration and total loading to the natural environment. Septic systems are prevalent in many residential developments. The costs of conversion and connection to sewer systems is high, but necessary.
- Water quality standards and restoration efforts implemented to meet these standards have the potential to mitigate the most adverse effects of LBSP on water quality and coral reefs/aquatic habitat in the region.
- Climate change and sea level rise (SLR) present new challenges and constraints (and impart a sense of urgency to act) to effective management of LBSP and stormwater runoff. Alternative LID/GI approaches offer a means to partially counterbalance these stressors and accelerate progress toward our water quality goals.

2.1. Hydrogeologic Characteristics

2.1.1. Geology and soil characteristics

The southern portion of the Florida peninsula is made up of up to 20,000 feet of sedimentary rock, overlying volcanic bedrock from the Pleistocene era. Porous limestone layers contain karst features such as sinkholes, springs, and caves. The primary geographic areas that contribute stormwater into the estuaries and coastal waters along Southeast Florida are part of the Southern Atlantic Coastal Strip and Eastern Flatwoods District physiographic provinces. Subdivisions within this region include the Green Ridge-Loxahatchee Karst, Andytown Ridges and Sloughs, Green Acres Sand Prairie, and Pompano-Fort Lauderdale Gap. The Atlantic Coastal Ridge runs through the area and has a width of about 10 miles in the southern end, narrowing to 3 to 5 miles in the northern portion. Elevations on the southern portion of the ridge range from 5 to 20 feet. The ridge separates most of the Everglades from the Atlantic coast,

turning much of its surface flow into Florida Bay.²³ The Atlantic Coastal Ridge has been extensively developed for urban uses, and its relatively higher land provides protection from flooding and deeper soils suitable for stormwater infiltration. To the west of the ridge, lower-lying sandy flatlands extend inland to wetlands in the Everglades.

Soils tend to be dominated by well-drained sandy soils with a shallow depth above the seasonal high groundwater table (SHGT). The most common hydrologic soils group (HSG) classifications are A/D and B/D soil, which reflect the combination of high permeability under dry conditions but slow permeability under saturated conditions (Figure 2-1 Miami-Dade County, Figure 2-2 Broward County, Figure 2-3 Palm Beach County, and Figure 2-4 Martin County).

²³ National Park Service. (2018, February 13). *Geology - Everglades National Park*. Retrieved from <https://www.nps.gov/ever/learn/nature/evergeology.htm>

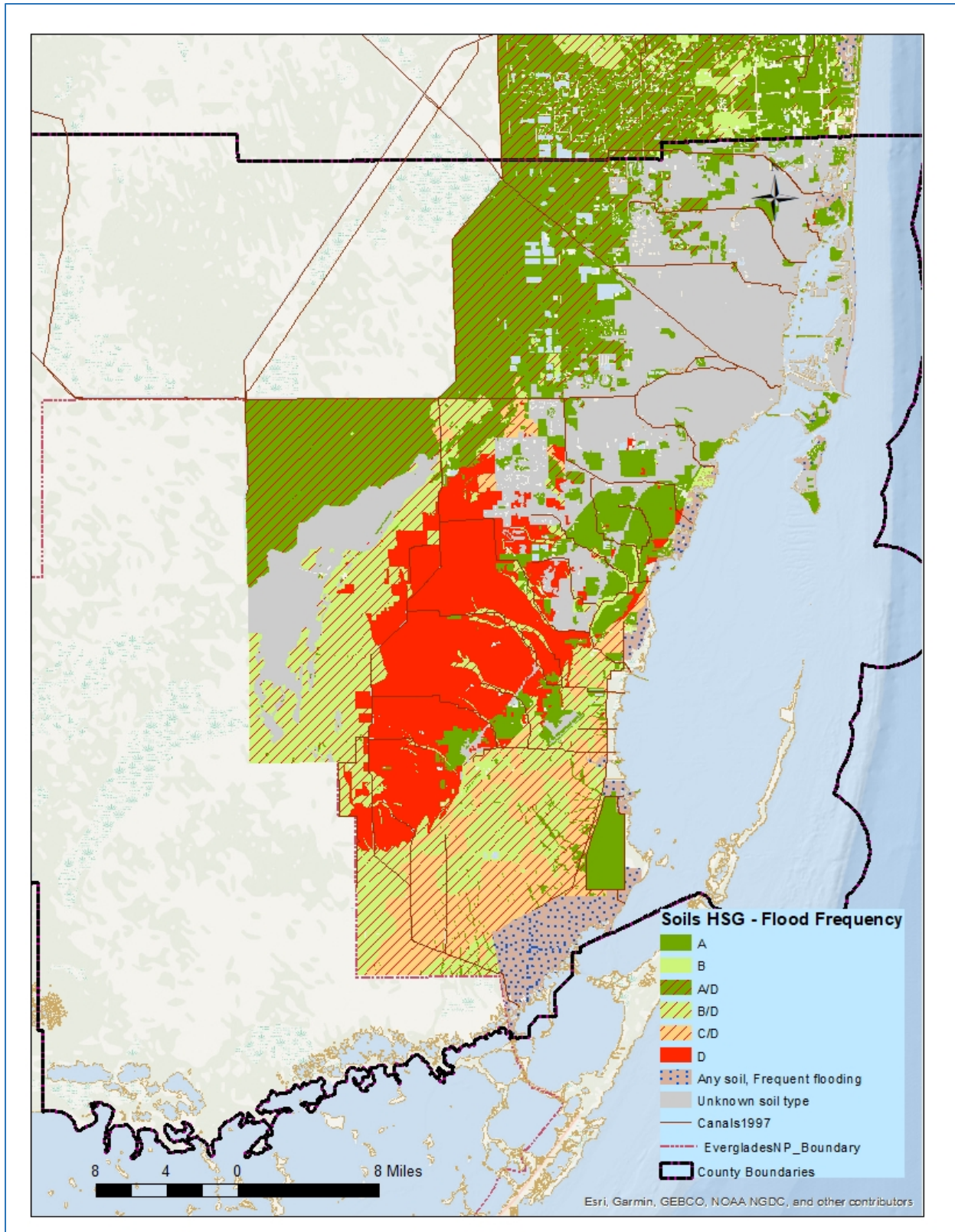

Figure 2-1. Hydrologic soils group and flood frequency for Miami-Dade County.

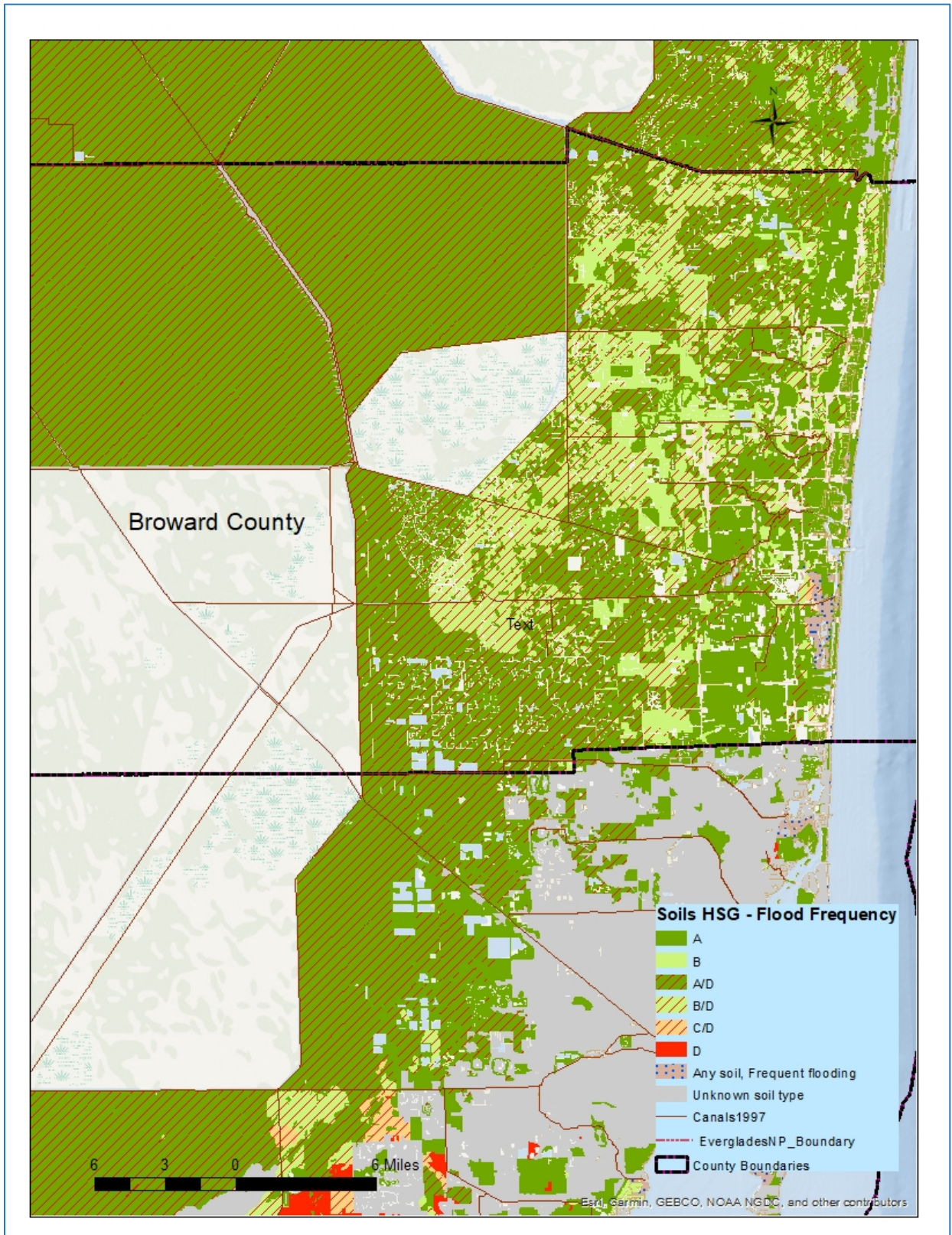

Figure 2-2. Hydrologic soils group and flood frequency for Broward County.

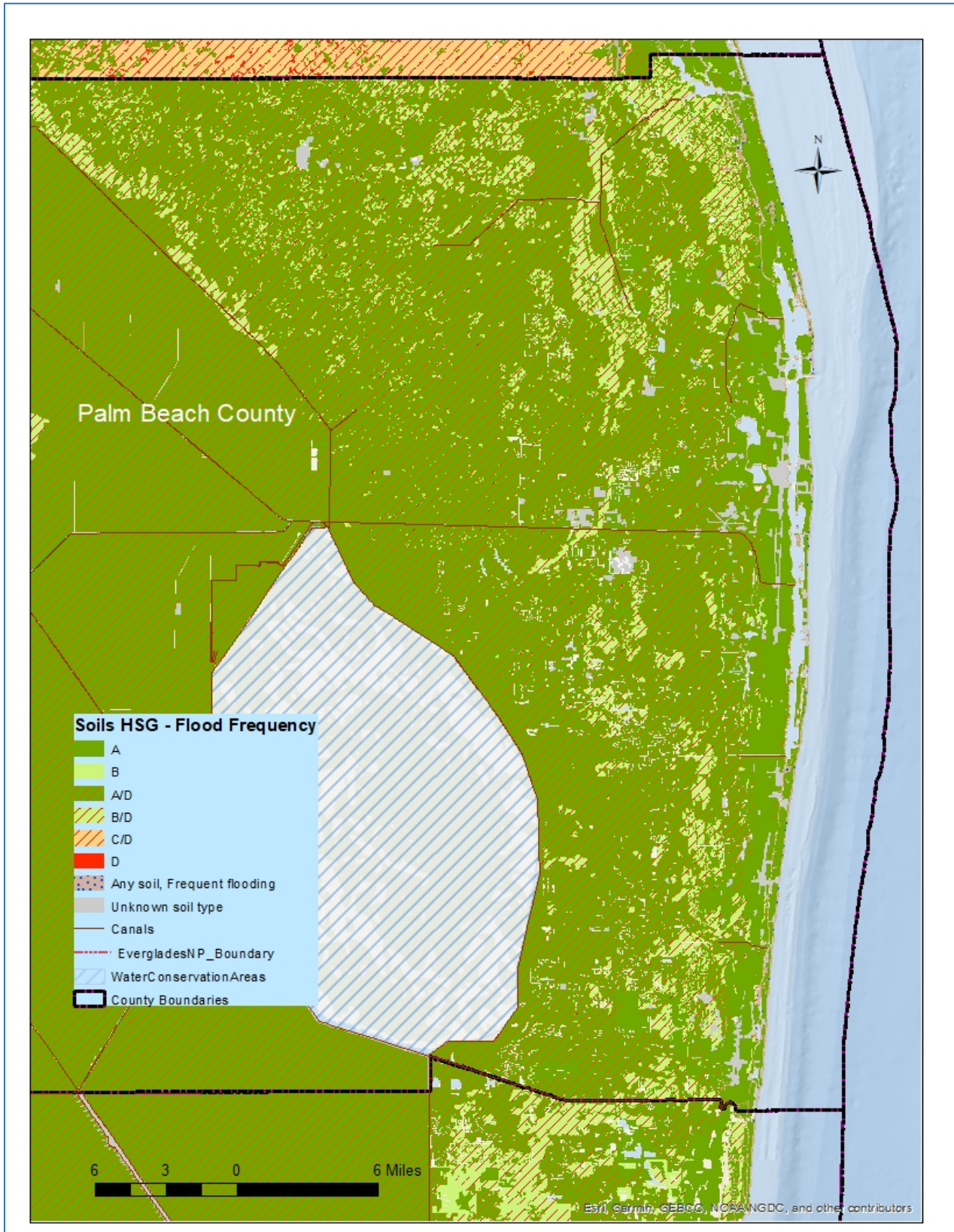

Figure 2-3. Hydrologic soils group and flood frequency for Palm Beach County.

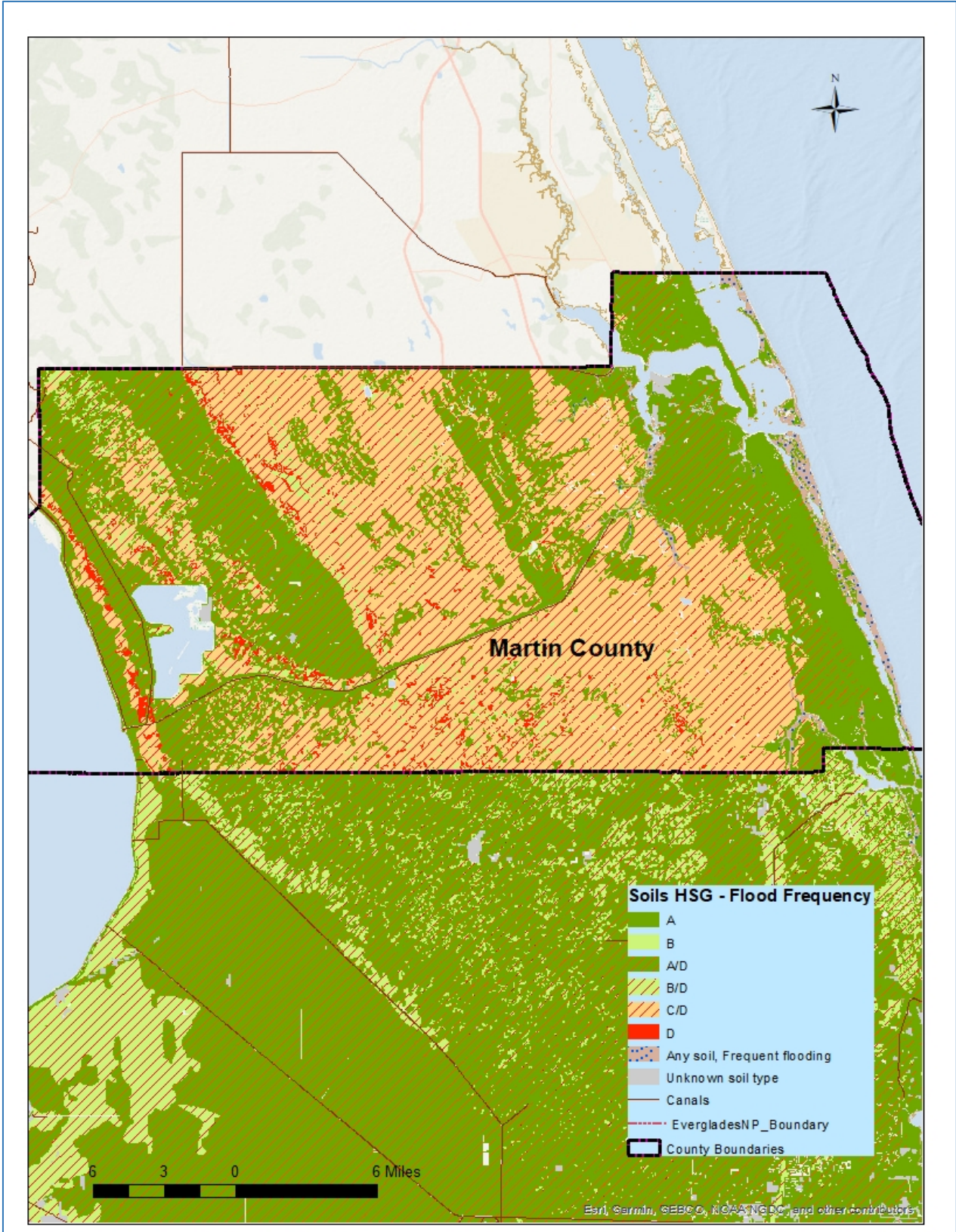

Figure 2-4. Hydrologic soils group and flood frequency for Martin County.

2.1.2. Climate of Southeast Florida

Mean monthly temperatures measured at the West Palm Beach Airport for the period 1989-2018 ranged from 66.8°F in January to 83.4°F in August, with summer high temperatures about 90°F and winter lows down to about 58°F (Figure 2-5). Annual rainfall averaged 60.5 inches; several summer months averaged rainfall totals of over 8 inches, while winter months were driest, averaging around 3 inches per month (Figure 2-6).²⁴

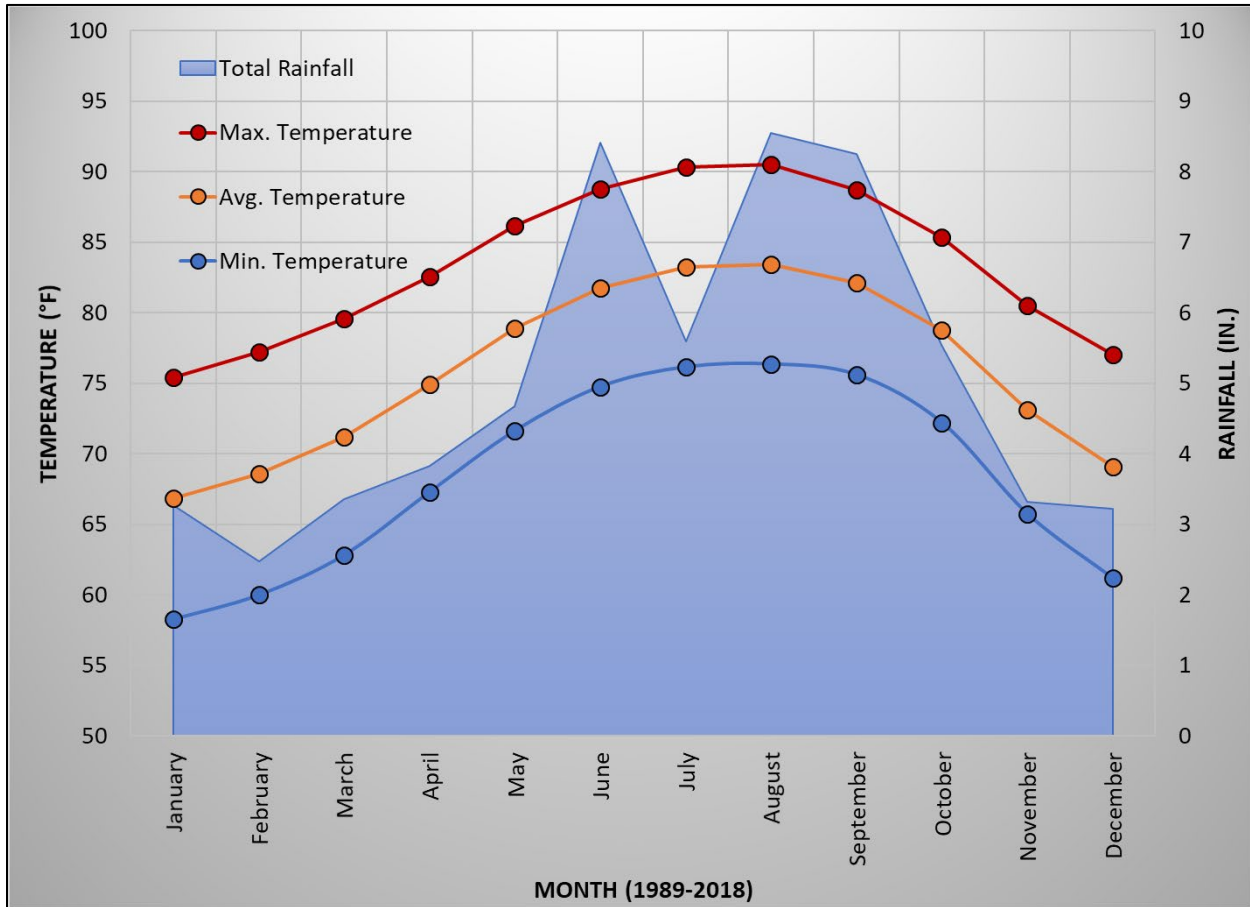

Figure 2-5. Normal monthly temperatures and precipitation totals from the West Palm Beach International Airport (1989-2018).

²⁴ National Climate Data Center, (n.d.). *West Palm Beach Climate Data, 1989-2018 Normals*. Florida State University. Retrieved August 21, 2019 from <https://www.ncdc.noaa.gov/cdo-web/datasets/GHCND/stations/GHCND:USW00012844/detail>

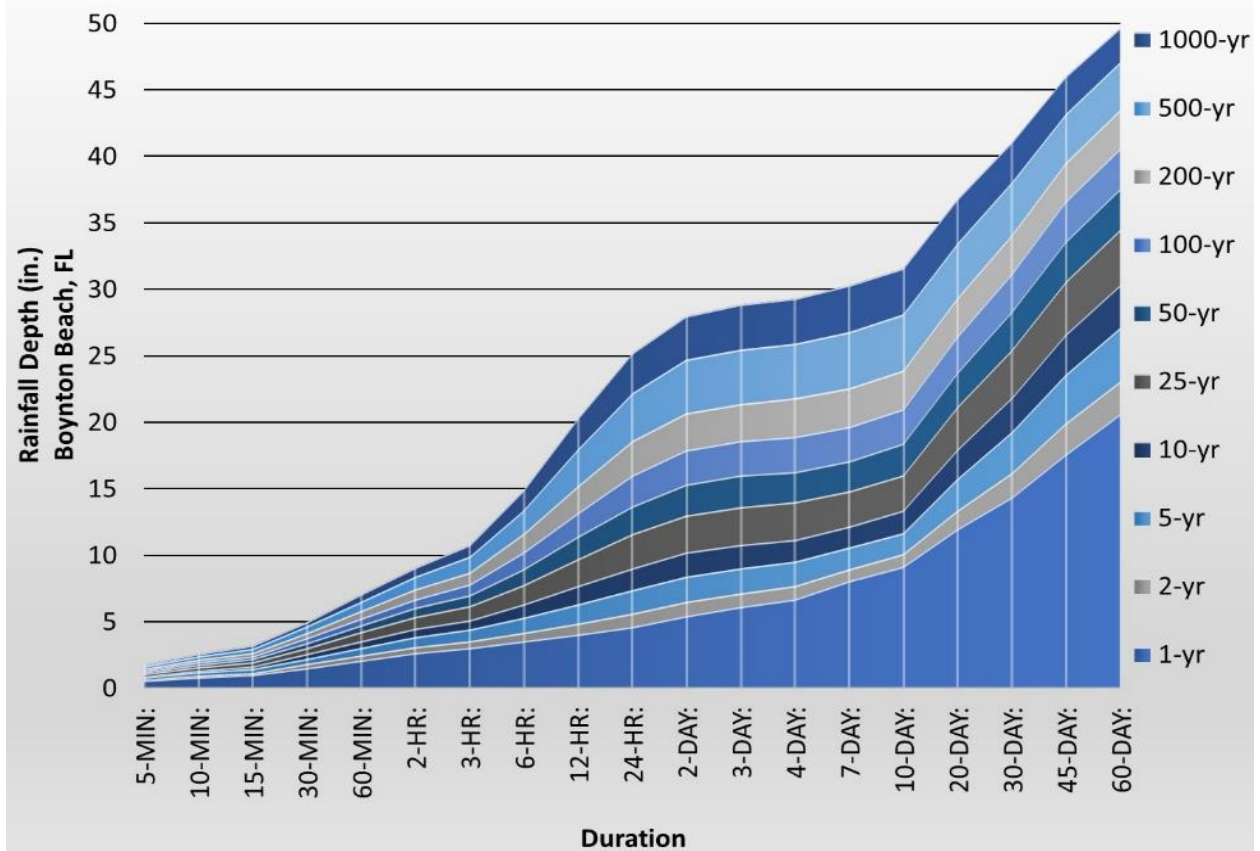

Figure 2-6. Boynton Beach rainfall depth, duration, and frequency data.

2.1.3. Topography and drainage

Before development of Southeast Florida began, surface drainage from the Kissimmee River basin flowed into Lake Okeechobee, with no natural outlet except periodic overflow along its southern bank into the Everglades. Sheet flow across the Everglades' sawgrass plain slowed and filtered the water, allowing infiltration before much of the remaining surface water drained into Florida Bay. The eastern coastal area was partially divided from this system by a high sand ridge (roughly along the present location of I-95), but small rivers cut across the ridge, connecting the Everglades to some eastern coastal estuaries. However, groundwater upwelling into southern Miami-Dade County provided the dominant source of freshwater in the eastern coastal plain.

As the region was developed, major changes to the surface drainage were made. Wetlands were drained for agriculture and urban infrastructure; surface water was re-routed. Straightening of the Kissimmee River, construction of a dike on the south side of Lake Okeechobee, and numerous other levees and large canals efficiently transferred surface water to the St. Lucie and Caloosahatchee estuaries. While the system effectively prevented flooding, the altered drainage drastically changed the area's ecology, shrinking the Everglades by half, decreasing the freshwater supply to Florida Bay and Biscayne Bay and increasing fresh water to estuaries to the north, such as the Indian River Lagoon and the St. Lucie and Caloosahatchee estuaries. Major projects to restore portions of the natural system have been completed and are ongoing. But the basic canal/levee drainage pattern (described in Section 2.2.1) will continue to carry excess water from Lake Okeechobee into the eastern estuaries into the foreseeable future.

2.2. Unique Challenges

Southeast Florida shares common challenges with other coastal areas in addition to its own unique challenges. Pollutants carried by stormwater and wastewater discharges are a common concern for marine habitats and fisheries, but the detrimental impacts of pollution on Florida's coral reefs provide extra impetus to improve water quality and protect these fragile habitats. Other concerns that the region faces include: the potential for saltwater to intrude into wells supplying potable water, the need to manage stormwater from unpredictable changes in the amount and intensity of precipitation, and how to encourage new urban growth in areas that are the least likely to be affected by flooding in communities with low topography.

Increased inland flooding is a likely consequence of sea level rise, and Southeast Florida may be increasingly vulnerable if higher sea levels infiltrate through the porous rock, raising inland groundwater levels and inundating low lying land and hindering the ability of the region's canal system to drain stormwater. "Sunny day" flooding during King Tides ([exceptionally high tides](#)) and as a result of higher sea levels is increasingly a problem in some areas. Also, significant portions of the four-county area experience relatively high groundwater (Figure 2-7) for varying lengths of time (Figure 2-8), which limits options for flood and stormwater management.

2.2.1. Surface, groundwater, and coastal water connectivity

Surface water, groundwater, and coastal sea water should never be considered as entities without interactions between the various bodies of water. In Southeast Florida, connectivity is especially common, as conduits in the porous limestone allow surface water to quickly enter groundwater, which in turn flows easily into streams, lakes, canals, and estuaries. Therefore, pollutants in one body of water are also transferred between water bodies. For example, nitrogen is naturally very low in groundwater, but elevated levels from fertilizers, human, or animal wastewater can lead to increased plant and algal growth in surface or coastal waters. Natural phosphorus levels in Florida vary greatly by soil type and anthropogenic sources, but relatively small changes in the natural water chemistry can cause significant changes to aquatic habitats. Dissolved oxygen is normally very low in groundwater, and lower than normal values in surface waters may indicate unusually high inflows of groundwater.²⁵

Portions of the predevelopment sheet flow of water from the Kissimmee River and Lake Okeechobee across the Everglades' sawgrass plains remain, and major projects are on-going to restore more of the ecosystem's original flow paths into Florida Bay. The natural small rivers that cut across the sand ridge to the east, connecting the Everglades to eastern coastal estuaries, are joined by a large network of canals draining often nutrient-laden fresh water from local basins and Lake Okeechobee to the estuaries. Local drainage normally makes up the majority of stormwater, and discharge from Lake Okeechobee makes up about 25-30% of the total flow. The additional fresh water reduces salinity levels and adds nitrogen and phosphorous to coastal waters. At times, freshwater algal blooms are also carried to the coast, adding organic material that can deplete dissolved oxygen as it decomposes.

²⁵ Florida Department of Environmental Protection. (2018). *Final integrated water quality assessment for Florida: 2018 Sections 303(d), 305(b), and 314 report and listing update*. Retrieved from https://floridadep.gov/sites/default/files/2018_integrated_report.pdf

Three tiers of drainage canals control water movement in the system:

1. Large primary canals are managed by the South Florida Water Management District (SFWMD) and the U.S. Army Corps of Engineers, controlling regional water levels with numerous gates, sluices, and pumps to provide flood control and groundwater recharge (Figure 2-9).
2. Secondary canals collect runoff from smaller watersheds, drain into the primary system, and are controlled by special “drainage districts.”
3. The tertiary drainage system is composed of storm sewers, swales, and detention ponds as the initial collection point for runoff, and they are often managed by property owners or neighborhood associations. The tertiary system provides treatment and detention in the stormwater management system.²⁶

2.2.2. Existing land uses

Land use in Martin, Palm Beach, Broward, and Miami-Dade counties is heavily urbanized along the coast, but some agricultural and undeveloped lands exist, primarily to the western side of the area (Figure 2-10). Future development is generally expected to increase density in existing urban/suburban areas, although without continuing regulatory protection, boundaries may be moved, and development could be allowed to spread further into natural and agricultural areas.

2.2.3. Coral reef resource and protection

The Florida reef tract includes three major coral reef lines off the coast of Miami-Dade, Broward, Palm Beach, and Martin counties, and is important for their ecological, economic, and aesthetic values. These coral reef lines create jobs, economic benefits, and public recreation through opportunities to fish, snorkel, and dive. However, excess nutrients have long been known to degrade coral reefs through multiple mechanisms. For example, algae grow over and shade coral, interfering with their calcification and reproduction and increase coral death rates. Sediment carried by stormwater also reduces light penetration. The effects of other chemical pollutants in stormwater and wastewater effluent are still being evaluated, but they clearly have detrimental consequences for coral reef ecosystem habitats.²⁷

Pollutants reach the reefs from stormwater runoff and other sources carried into the Atlantic through nine inlets, five wastewater treatment plant outfalls, and two spoil disposal sites from ocean dredging. The Florida Department of Environmental Protection is responsible for state regulations to protect the reef ecosystems. Working with the U.S. EPA, the previous “narrative” water quality standards are being replaced by numeric nutrient criteria. While limits have been adopted for lakes, streams, spring vents, and some estuaries in the state, those for the southern Indian River Lagoon, parts of the Intracoastal Waterway, and connecting estuarine systems are not completed. Estuary-specific nutrient limits are being set for total nitrogen (TN) and total phosphorus (TP) based on chlorophyll-a concentration and other data collected from in situ assessments on the response of coral reefs to excess nutrients.

²⁶ Strowd, T., Kivett, J., Gassman, N., Cunningham, B., Bregman, J., & Smith, E. (2017). *Regional impacts of climate change and issues for stormwater management*. Southeast Florida Regional Climate Change Compact. Retrieved from <http://www.southeastfloridaclimatecompact.org/wp-content/uploads/2015/11/Stormwater-Guide.pdf>

²⁷ Wear, & Thurber. (2015). Sewage pollution.

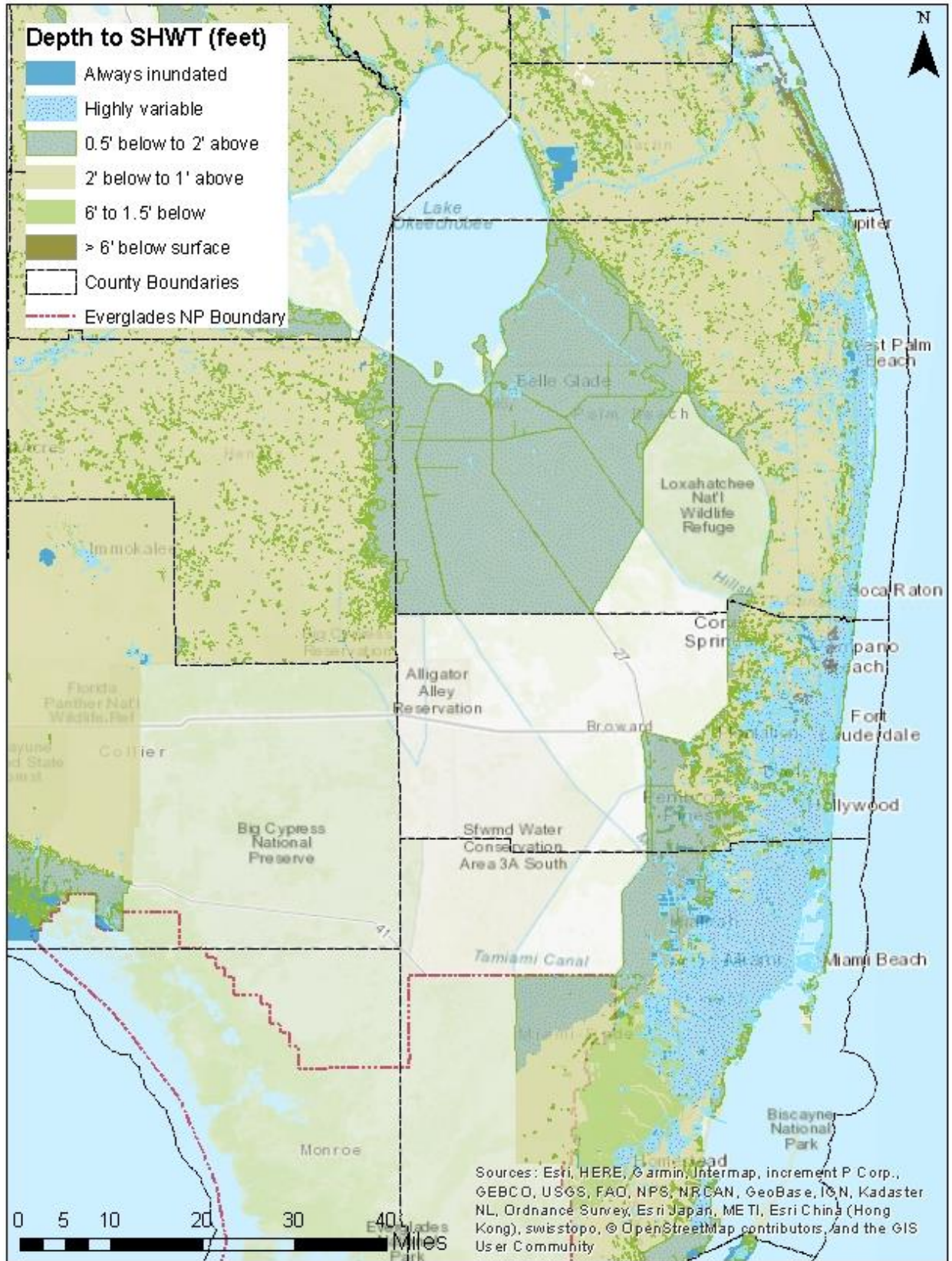

Figure 2-7. Current (2019) depth to the seasonal high groundwater table.

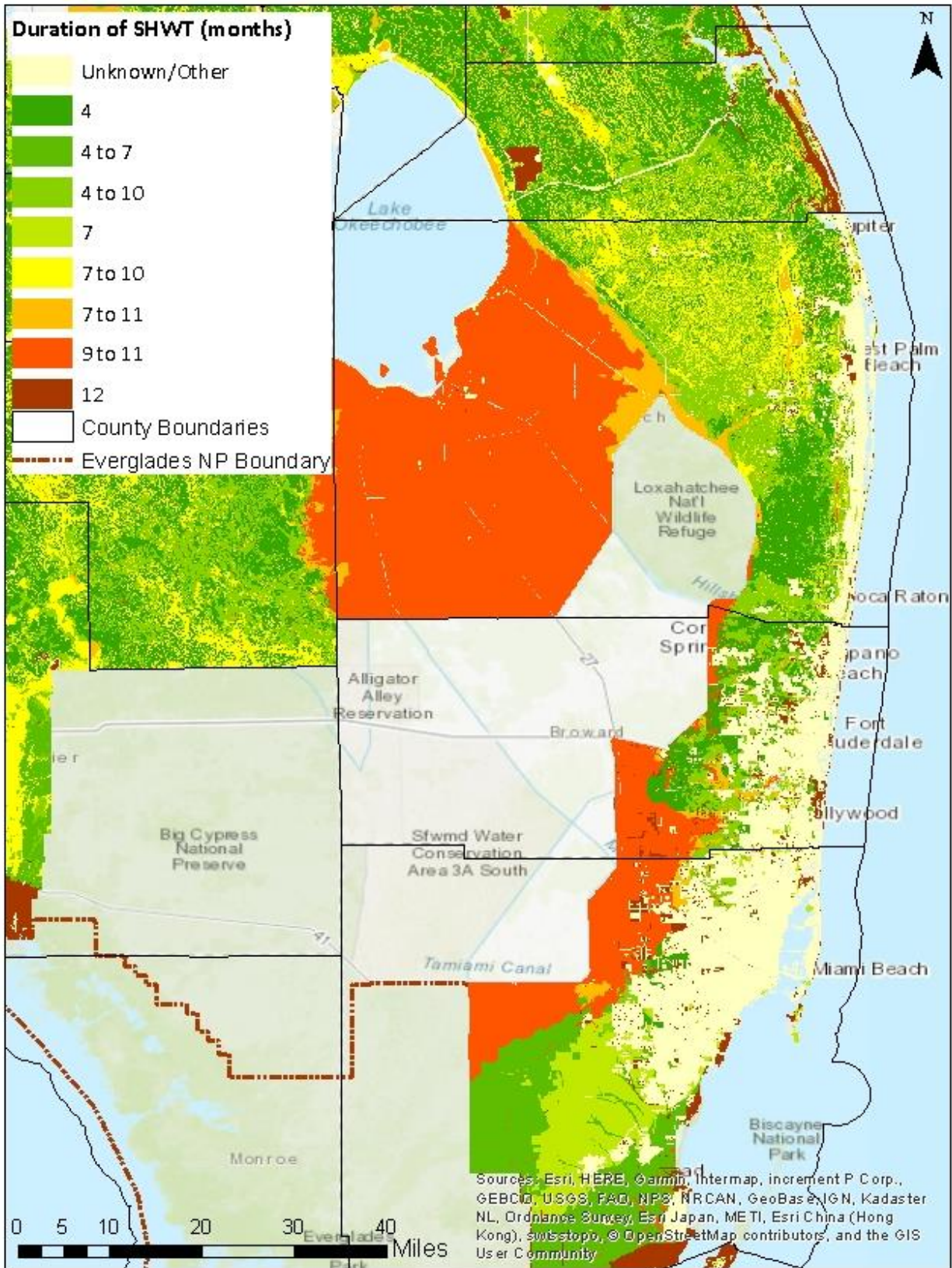

Figure 2-8. Approximate duration of seasonal high groundwater table.

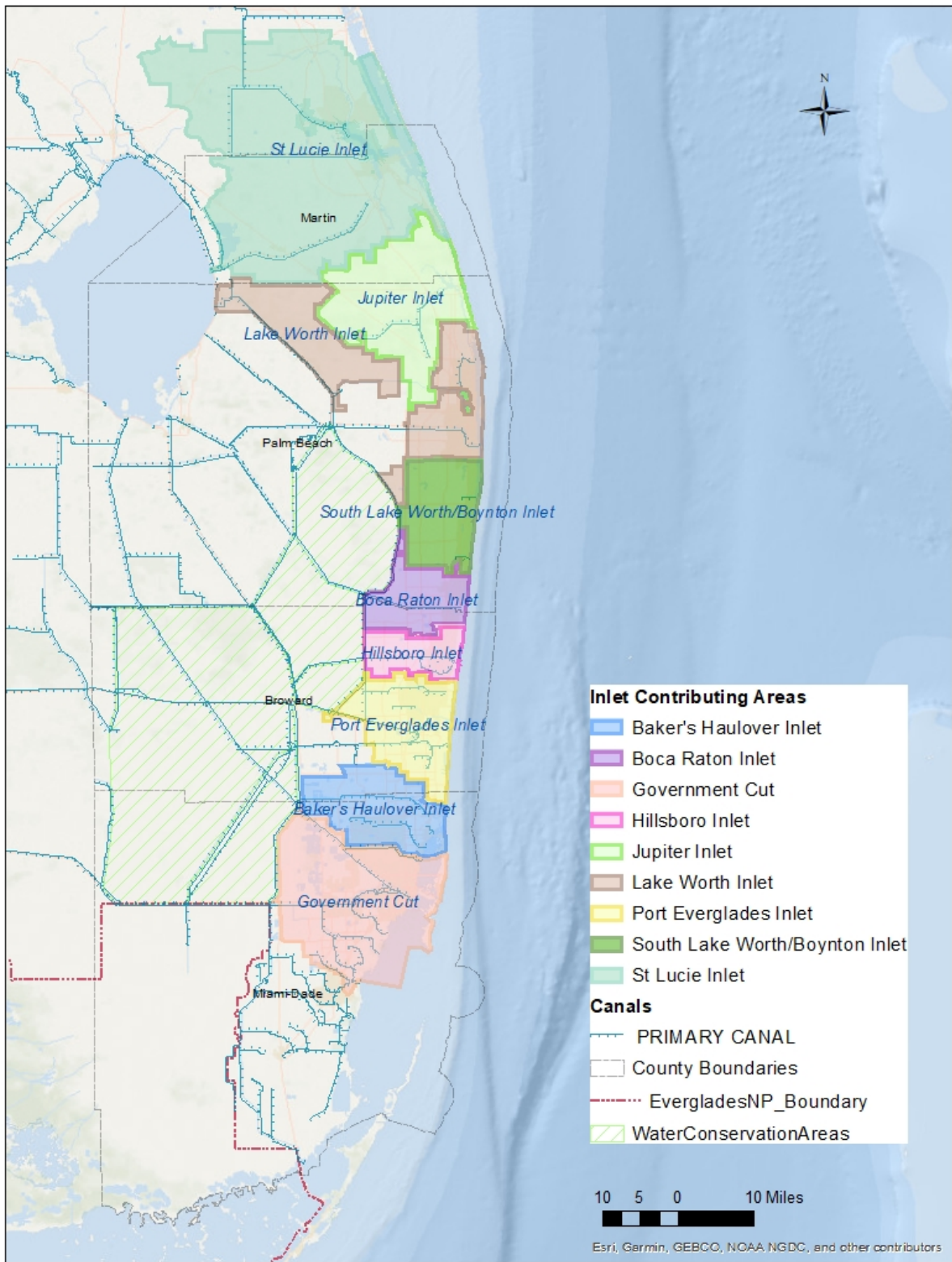

Figure 2-9. Watersheds contributing to estuary inlets and the primary canal system in Southeast Florida.

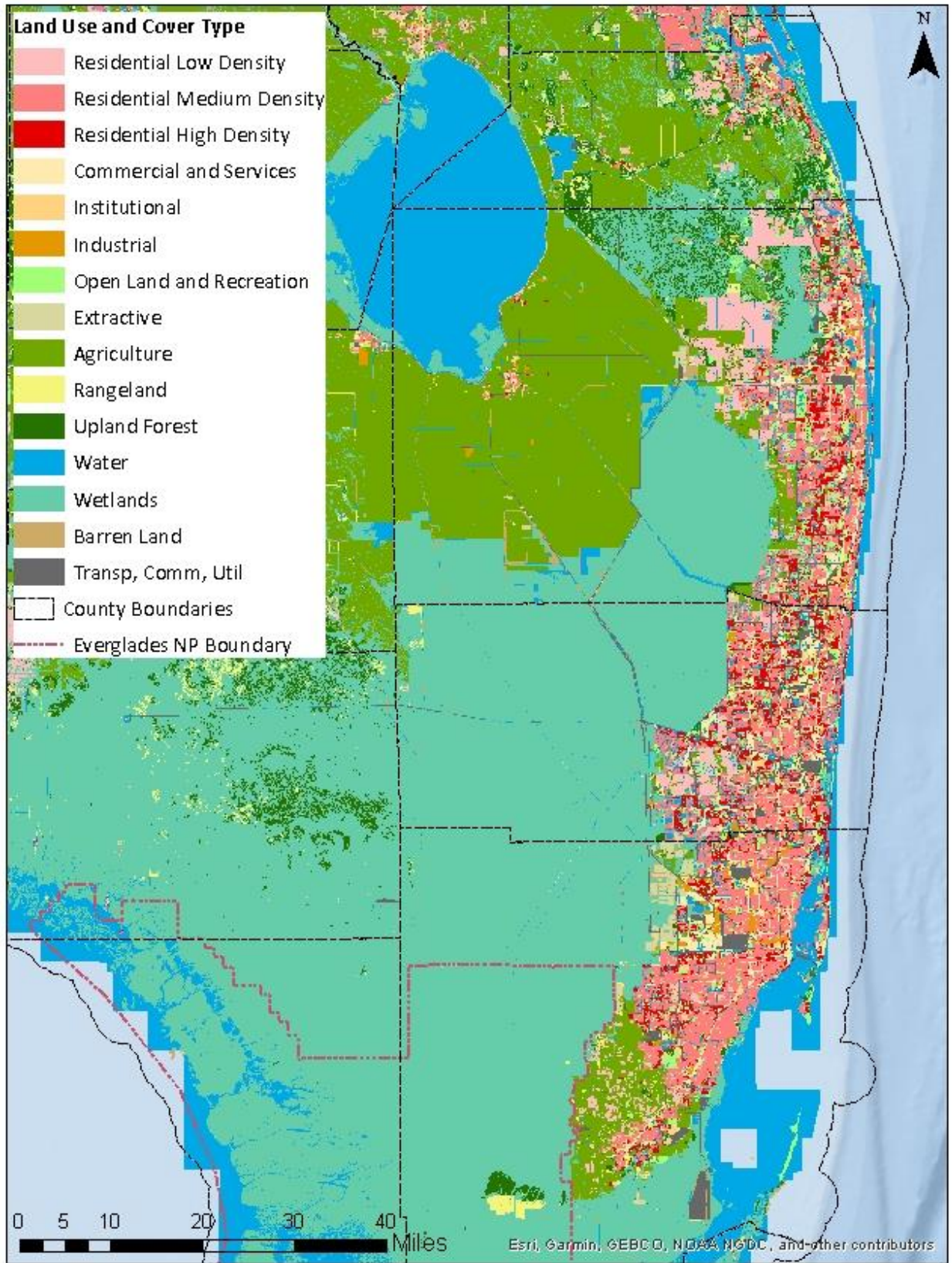
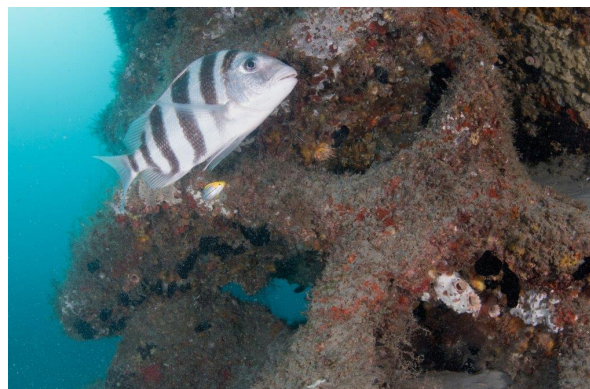

Figure 2-10. Current land use.

In 2015, scientists working with NOAA’s Coral Reef Conservation Program and the FDEP initiated the [Southeast Florida Reef Tract Water Quality Monitoring Plan](#) to establish baseline water quality characteristics and describe changes over time so that management efforts can be evaluated and improved to sustain the reefs’ health.²⁸ Other ongoing projects include Palm Beach State College’s [Reef Hope Project](#), where students are building numerous artificial reefs in conjunction with various agencies, non-profit organizations, and foundations.



2.2.4. Sea level rise and sunny day flooding

Coastal communities in Southeast Florida, especially southern Miami-Dade County, are experiencing more frequent inundation, particularly from “sunny day” flooding during unusually high King Tides. This is being exacerbated by sea-level rise. High tides top seawalls more frequently, and increased rainfall intensity has caused significant flooding, even in normally drier winter months. Groundwater levels respond by rising quickly, inundating sub-surface drainage systems. This causes some stormwater drains to reverse direction and forces water back up through manholes, flooding streets.

Normal flow through most of the regions’ canal systems depends on gravity, but that process is being compromised by rising water levels. Portions of the canal system can be expected to fail under the projected sea levels. In fact, eighteen salinity control structures on primary canals are within 6 inches of their maximum design levels, and downstream tidal flooding is currently making it necessary to periodically close some gates, preventing stormwater drainage. Additional flooding will occur upstream of these structures to the degree that they and other gates closures will become necessary.²⁹

Planning for new development or infrastructure improvements will need to carefully consider the most recent projections for inundation mapping, changes in groundwater levels, sea level rise, and changes to rainfall patterns to avoid exacerbating flooding and to protect areas where feasible. The potential for saltwater intrusion into surficial aquifers must also be evaluated. Decision support tools toward this goal are being developed by communities in the Southeast Florida Regional Climate Change Compact.

²⁸ Whitall, D., Bricker, S., Stamates, J., Gregg, K., Baez, J., Cox, D., ... Wolfe, L. (2016). *Southeast Florida reef tract water quality monitoring plan* (p. 22). NOAA. Retrieved from <https://repository.library.noaa.gov/view/noaa/13199>

²⁹ Groves et al. (2018). *Adapting land use and water management plans*.

2.2.5. Water body classifications and impairment conditions

Twelve waterbodies in Southeast Florida are classified as impaired in the final 2017 listing from the Florida Department of Environmental Protection (FDEP), including Biscayne Bay, the Intracoastal Waterway and Atlantic Ocean in Miami-Dade County, and the Port of Miami for Nutrients (total nitrogen or chlorophyll-a). Several canals are impaired for specific conductance, and the North Fork of the New River is impaired for copper.³⁰ Impairment for chlorophyll-a indicates excess algal growth, which is boosted by N and P from multiple anthropogenic sources, as discussed in Sections 1.3.1, 1.3.2, and 2.2.6.

Listing impaired waters is the third step in a process to determine actions necessary to restore water quality. FDEP staff are currently determining the maximum pollutant loads that can be discharged into a waterbody without harming its designated uses, or its total maximum daily loads (TMDLs). Developing the Basin Management Action Plans (BMAP) will be the final administrative step in the process. An [interactive map](#) of the impaired waters, TMDLs, and BMAPs is available from the Florida Department of Environmental Protection. Some local municipalities are collaborating to address the problem through regional assurance plans (RAPs), such as the Loxahatchee River Reasonable Assurance Plan (RAP),³¹ before a BMAP is developed (discussed further in Section 2.3.3).

2.2.6. On-site wastewater treatment systems

PREVALENCE IN SOUTHEAST FLORIDA

There are between 2.1 to 2.7 million onsite wastewater and disposal systems (OSTDS), or septic systems in Florida.³² They are most frequently used in rural areas, but they were also commonly installed in older residential areas and on barrier islands. Although there are significant gaps in the data indicating which areas are served by septic or by central wastewater, it is clear that each of the four Southeast Florida counties have significant numbers of OSTDS (Figure 2-12). Properly designed systems installed in suitable locations provide good removal of bacteria and phosphorous as wastewater leaving the drainfields percolates through the surrounding soil, but they are much less effective at removing nitrogen from the effluent. Studies of nitrogen in Florida estuaries experiencing algal blooms have found evidence that much of the nitrogen originated in OSTDS.³³

Onsite wastewater treatment and disposal systems are regulated statewide by the Florida Department of Health (FDOH). The Florida Administrative Code (F.A.C.) Chapter 381.0065 and Chapter 64E-6 include site evaluation criteria and design standards for OSTDS that require at least 24 inches of unsaturated soil between the bottom of a drainfield and the seasonal high water table elevation. High water tables in much of southeastern Florida are less than 48 inches below the ground surface, and during wet summer

³⁰Florida Department of Environmental Protection. (2018, April). Lists of impaired waters for the group 4 basins. Retrieved from <https://floridadep.gov/dear/watershed-assessment-section/content/lists-impaired-waters-group-4-basins>.

³¹ Espy, J. (2017, September). *Loxahatchee River Reasonable Assurance Plan*. Presented at the Loxahatchee River RAP Meeting. Retrieved from https://loxahatcheeriver.org/wp-content/uploads/2016/07/Lox-River_092517_Draft-C.pdf

³² Onsite Sewage Program, & Bureau of Environmental Health. (2017, June). *Onsite sewage treatment and disposal systems in Florida*. Retrieved from <http://fl-counties.com/sites/default/files/2017-07/Onsite%20Sewage.pdf>

³³Lapointe et al. (2015). *Evidence of sewage-driven eutrophication and harmful algal blooms*.

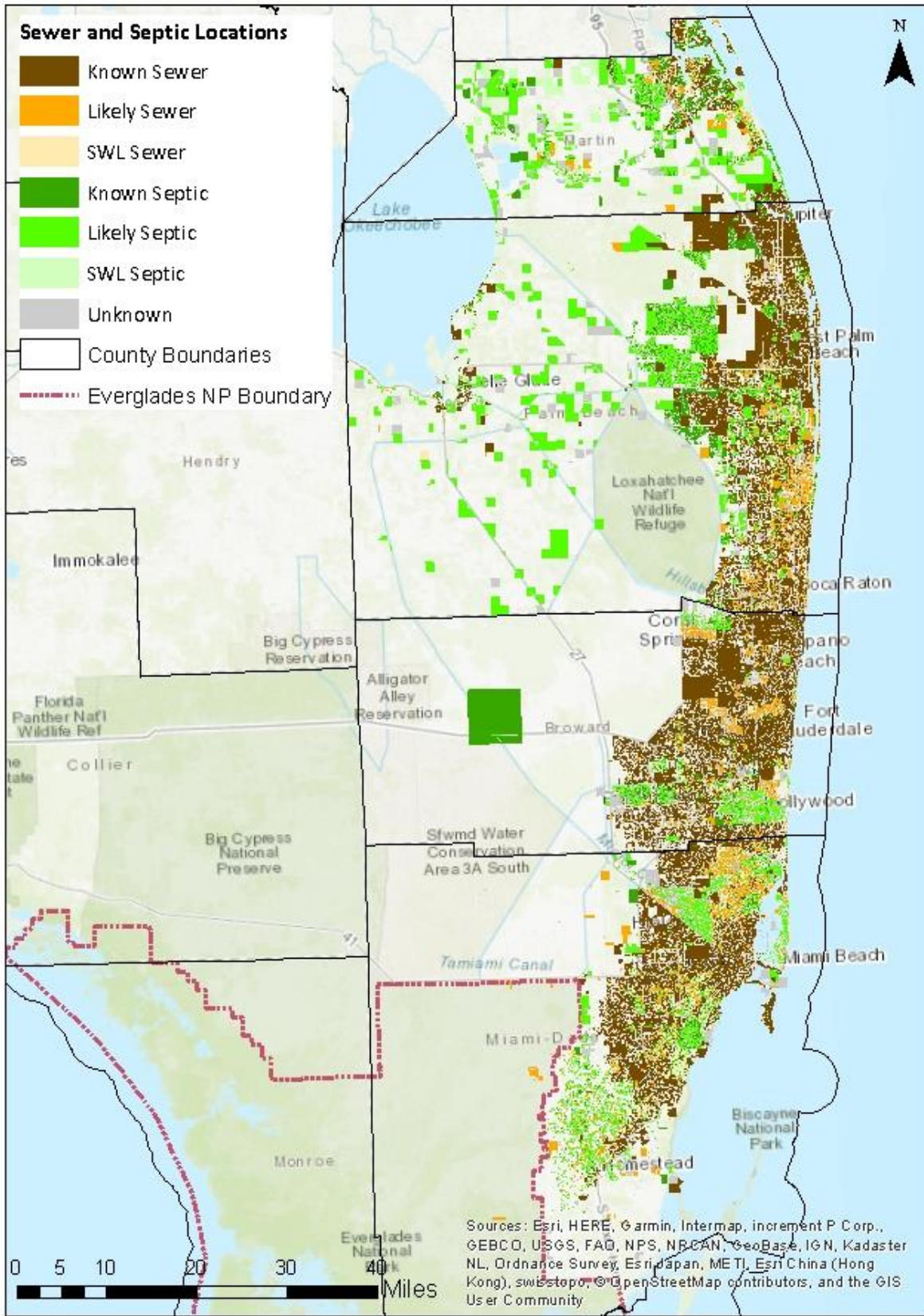

Figure 2-12. Known, likely, and somewhat-likely (SWL) locations of sewers and septic systems.

months, the water table can often be raised enough to reduce the available depth to 24 inches or less. If projected sea-level rises of 6-12 inches occur, then the number of OSTDS drainfields with insufficient treatment depth will increase, along with nutrient loads to surface and groundwater from inadequately treated septic effluent.

A second factor influencing the proper function of OSTDS is the presence of enough surface area to accept and treat the effluent. Drain fields are sized based on the number of bedrooms in a home and the soil type, with a general design range for a 3-bedroom home between 500 and 1,500 square feet. Many small lots are not able to meet this current standard, particularly in older neighborhoods and on the barrier islands. Some have been converted to advanced treatment systems, but current data from the FDOH does not distinguish by type of onsite system.

In recognition of these problems, some communities in Southeast Florida are working to disconnect homes from septic systems and connect them to central wastewater treatment plants. However, these are expensive projects, and large numbers of homes cannot be quickly converted. Options for alternative types of onsite wastewater disposal with much better treatment outcomes exist and may be evaluated for cost-effectiveness.

Alternative sewage collection systems employing pressure or vacuum lines may also be feasible options with lower cost and less construction disruption for communities. Pressure systems employ a small pump at each property to convey wastewater into larger collection pipes and ultimately to a central wastewater treatment plant. STEP systems continue to settle and treat solids at individual sites in septic tanks, only discharging the tank effluent to central wastewater treatment. Alternately, grinder pumps are used at each site, without the need for an onsite septic tank, and all household wastewater is pumped to a central treatment facility. Vacuum systems pull wastewater through pipes with a vacuum (negative pressure). The reversed pressure gradient means that wastewater does not readily leak from an unintentional gap in the pipes, but stormwater and groundwater can be drawn into the system.

NUTRIENT LOADS AND BACTERIAL POLLUTANTS

Nutrient loads from human activities originate from point sources, such as wastewater treatment plants or specific industrial or animal wastes. They can also originate from non-point sources, such as synthetic inorganic fertilizers used in agricultural, suburban residential, or urban areas and atmospheric nitrogen released from burning fossil fuels. Improved processes in wastewater treatment plants have minimized these sources of nutrients and pathogens in many locations, so that non-point sources now represent a much larger share of total nitrogen and phosphorus inputs to surface waters.

Bacteria, of course, are everywhere. Bacterial pollutants are those that can be pathogenic in humans and may be present in sewage. Rather than test for a wide range of pathogens, indicator organisms are used to signal the possible presence of human pathogens. Coliform bacteria (a category of bacteria that is always present in digestive tracts of many animals) or enterococcus (a more specific indicator) are used as flags that pathogens may be present. In coastal waters, shellfish can filter out pathogens, making them unsuitable for human consumption.

Wastewater treatment plants are highly effective at removing harmful bacteria, as are well-functioning septic systems. However, unsaturated soil under drainfields is necessary for filtration and aerobic decomposition of pathogens. Surface water and groundwater that has been in contact with flooded drainfields may contain pathogens, adding another concern to the dangers posed by rising seas. Sewage

from flooded manholes and sewer pipelines also poses the same threat, only in larger volumes. Public education is important to prevent or minimize exposure to flood waters, particularly as flooding becomes routine after heavy downpours or high tides.

2.3. Regulatory Framework

Stormwater quality and management is controlled by federal statutes, state regulations, and local ordinances that projects must comply with according to the jurisdictions within which they are located.

- **National:** At the national level, the Environmental Protection Agency (EPA) is the primary administrator of environmental statutes related to urban stormwater runoff, which are largely derived from the Clean Water Act.
- **State:** The EPA delegates authority to the Florida Department of Environmental Protection (FDEP) to administer certain sections of the Clean Water Act and to administer stormwater regulations at the state level.
- **Regional:** In Southeast Florida, the counties of Martin, Palm Beach, Broward, and Miami-Dade are all within the South Florida Water Management District (SFWMD). The FDEP oversees the five Water Management Districts within Florida and delegates the administration of water resource regulations at the regional level, specifically the permitting program under which stormwater management falls, known as Environmental Resource Permitting.
- **Local:** Some county and municipal governments within SFWMD also have created local ordinances that pertain to management of stormwater.

In unique situations, variances can be granted by the administering authority to allow for deviations from complying with requirements. Permitting for most types of multi-unit land development, commercial marinas and public boat ramps will require an environmental resource permit from the SFWMD and must be approved by the county and, if applicable, the municipality. Environmental resource permits for single-unit residential development and associated docking facilities are reviewed by the FDEP Environmental Resource Program.

2.3.1. National: Clean Water Act

The Clean Water Act, passed by Congress in 1972, is the basis for laws and policies protecting surface water quality throughout the country. Its goal is to restore and maintain the “chemical, physical, and biological integrity of the nation’s waters” to ensure that various beneficial uses can be maintained, specifically, “the protection and propagation of fish, shellfish, and wildlife and recreation in and on the water.” Several programs were established to implement various sections of the Clean Water Act. The most relevant programs are listed below.

- **National Pollutant Discharge Elimination System Permit Program** – Section 402 of the Clean Water Act regulates point source discharges.
- **Total Maximum Daily Loads** – Section 303d of the Clean Water Act requires states to evaluate all water bodies and determine which are impaired and cannot be used for all of their designated beneficial uses. TMDLs are then developed, representing the maximum load or concentration of pollutants that the body of water can accept without exceeding their water quality standards.

- **National Estuary Program** – This program is administered by the EPA based on Section 320 of the Clean Water Act.
- **Section 404 Clean Water Act** – This section regulates dredge and fill materials that are discharged into the U.S. waters and wetlands.
- **Coastal Zone Act Reauthorization Amendments** – Section 6217 of the Coastal Zone Act Reauthorization Amendments (CZARA) requires that states with approved coastal zone management programs develop Coastal Nonpoint Pollution Control Programs.

2.3.2. Statewide: Florida Department of Environmental Protection

NUMERIC NUTRIENT CRITERIA

Over several decades, the rapid growth of both urban and agricultural areas in South Florida caused major hydrologic changes, degraded water quality, loss of habitat, and eutrophication of fresh and marine waters. A lawsuit from the federal government in 1988 for water quality violations spurred the state to make regulatory changes with the intent to reverse the damage and restore healthy hydrologic function to Florida’s waters. However, Florida’s standards proved inadequate. In 2009, the EPA and the Florida Wildlife Federation “[entered into a Consent Decree](#)” to replace former narrative water quality criteria with specific numeric limits to protect ecosystems from anthropogenic sources of nutrients. These are known as numeric nutrient criteria.

SURFACE WATER QUALITY STANDARDS

In 2012, the FDEP submitted new and revised water quality standards for springs, lakes, and streams to the EPA in accordance with section 303(c) of the Clean Water Act, now Surface Water Quality Standards, Rule 62-302 of the Florida Administrative Code (F.A.C.). These criteria vary with the type of surface water, i.e., springs vs. lakes and its class of use. Five classes of designated uses for surface waters are defined by the rules listed in the Florida Administrative Code (F.A.C.) Chapter 62-302 Surface Water Quality Standards, as follows:

- **Class I** – Potable Water Supplies
- **Class II** – Shellfish Propagation or Harvesting
- **Class III** – Recreation, Propagation, and Maintenance of a Healthy, Well-Balanced Population of Fish and Wildlife
- **Class IV** – Agricultural Water Supplies

While categorical numeric nutrient criteria have been established for Classes I, II, and III surface waters, estuaries and coastal areas have specific criteria by location that include specific analyses addressing responses to pollutants or standard reference distributions. The final estuary criterion ([Section 62-302.532, F.A.C.](#)) applies to open water and area-wide averages and not to wetlands or to tidal tributaries that fluctuate between predominantly marine and predominantly fresh waters. However, wetlands adjacent to other surface waters are subject to the same class criteria as their associated water body. Other specific numeric standards have not yet been developed and adopted for wetlands and canals.

IMPAIRED WATERS

Section 305(b) of the Clean Water Act requires states to report whether the water quality of individual streams, lakes, and estuaries is healthy enough to meet their designated uses. These reports are the basis for Florida's list of "Impaired Waters" (detailed in Section 303d of the Clean Water Act; 303(d) List). Impairment in those waters may be listed as being caused by point or non-point pollutant sources. The FDEP also submitted amendments to Rule 62-303, F.A.C. [Identification of Impaired Surface Waters] in 2012, which set out Florida's methodology for assessing whether waters are attaining state water quality standards.

Water bodies on the 303(d) (Impaired) list undergo the following critical actions:

- **Strategic Monitoring** – The impaired listing is verified, and data is collected for TMDL development.
- **Developing and Adopting TMDLs** – After basin TMDLs are developed, they are adopted and ranked highest to lowest priority.
- **Developing Basin Management Action Plan (BMAPs)** – A plan is developed that specifies how pollutant loadings will be allocated to all sources to meet TMDL requirements.
- **Implementing Watershed Management Plans** – BMAPs are implemented to improve water quality of the impaired waters.
- **Iterative evaluation and modification** – TMDLs and BMAPs are monitored and revised as needed in multiple phases if the targeted levels are not reached.

TMDLs AND BMAPs FOR IMPAIRED WATERS

As previously discussed, TMDLs are set as the upper limits of specific pollutants that the impaired water body is capable of assimilating without damaging its designated use. As part of the BMAP process, reductions are applied to the point and non-point sources of pollution in the watershed that are necessary to meet the TMDL. The allowed pollutant discharge for each source is known as the Waste Load Allocation. For example, MS4s³⁴ may implement stormwater retrofits or a wastewater treatment plant may be upgraded to meet their Waste Load Allocations. There are numerous impaired water bodies in the four-county area, some with established TMDLs in Palm Beach, Broward, and Miami-Dade Counties and BMAPs in Martin and Palm Beach Counties (Figure 2-13). BMAPs include a prioritized list of specific policies and projects that are to be implemented to achieve the target TMDLs, which may address both point and non-point pollution sources. Non-point sources may include stormwater not discharged through an MS4, urban and agricultural fertilizers, and onsite wastewater treatment and disposal systems. Water quality goals are set in five-year increments and should reach the TMDL levels in no more than 20 years.³⁵

³⁴ A Municipal Separate Storm Sewer System (MS4) is a regulated small municipal storm sewer system, including roads with drainage systems, municipal streets, catch basins, curbs, gutters, ditches, man-made channels, or storm drains.

³⁵ Borisova, T., Olexa, M. T., & Davis, J. (2018, February 23). *Handbook of Florida Water Regulation: Florida Springs and Aquifer Protection Act*. University of Florida. Retrieved from <http://edis.ifas.ufl.edu/FE1019>

NPDES STORMWATER PERMITTING PROGRAM

Stormwater runoff is typically classified as a non-point source of pollution. However, a storm sewer system collects, conveys, and discharges runoff via outfalls into downstream receiving waters. The NPDES stormwater permitting program was established to regulate stormwater discharges from Municipal Separate Storm Sewer Systems (MS4s). Phase I was promulgated in 1990 to address MS4s within incorporated places or counties with populations over 250,000 (large) and populations between 100,000 and 250,000 (medium). Phase I also included 11 industrial activities, such as large construction activities of 5 acres or greater. In 1999, Phase II was promulgated for any MS4s not regulated under Phase I and included construction activities disturbing between 1 and 5 acres. Within the four-county region, there are 106 Phase I MS4 facilities and 9 Phase II MS4 facilities (as of 2019).

Phase I MS4s permits are effective for up to five years, at which time the entity must re-apply for their permit. The Phase I MS4 program includes measures to:

1. Identify major outfalls and pollutant loadings;
2. Detect and eliminate non-stormwater discharges to the system;
3. Reduce pollutants in runoff from industrial, commercial, and residential areas;
4. Control stormwater discharges for new development and redevelopment areas; and
5. Implement a monitoring program.

Phase II MS4 permits are effective up to five years. The permit application is typically a Notice of Intent (NOI) to use Florida's generic permit for discharge from Phase II MS4s. The application includes six categories of minimum control measures:

1. Public Education and Outreach
2. Public Participation/Involvement
3. Illicit Discharge Detection and Elimination
4. Construction Site Stormwater Runoff Control
5. Post-construction Stormwater Management in New Development and Redevelopment
6. Municipal Operation Pollution Prevention and Good Housekeeping

Achieving control of stormwater discharges from new development and redevelopment is typically accomplished partly through the implementation of local ordinances and other regulations to address post-construction runoff.

The NPDES permitting program also covers discharge of effluent from wastewater treatment plants.

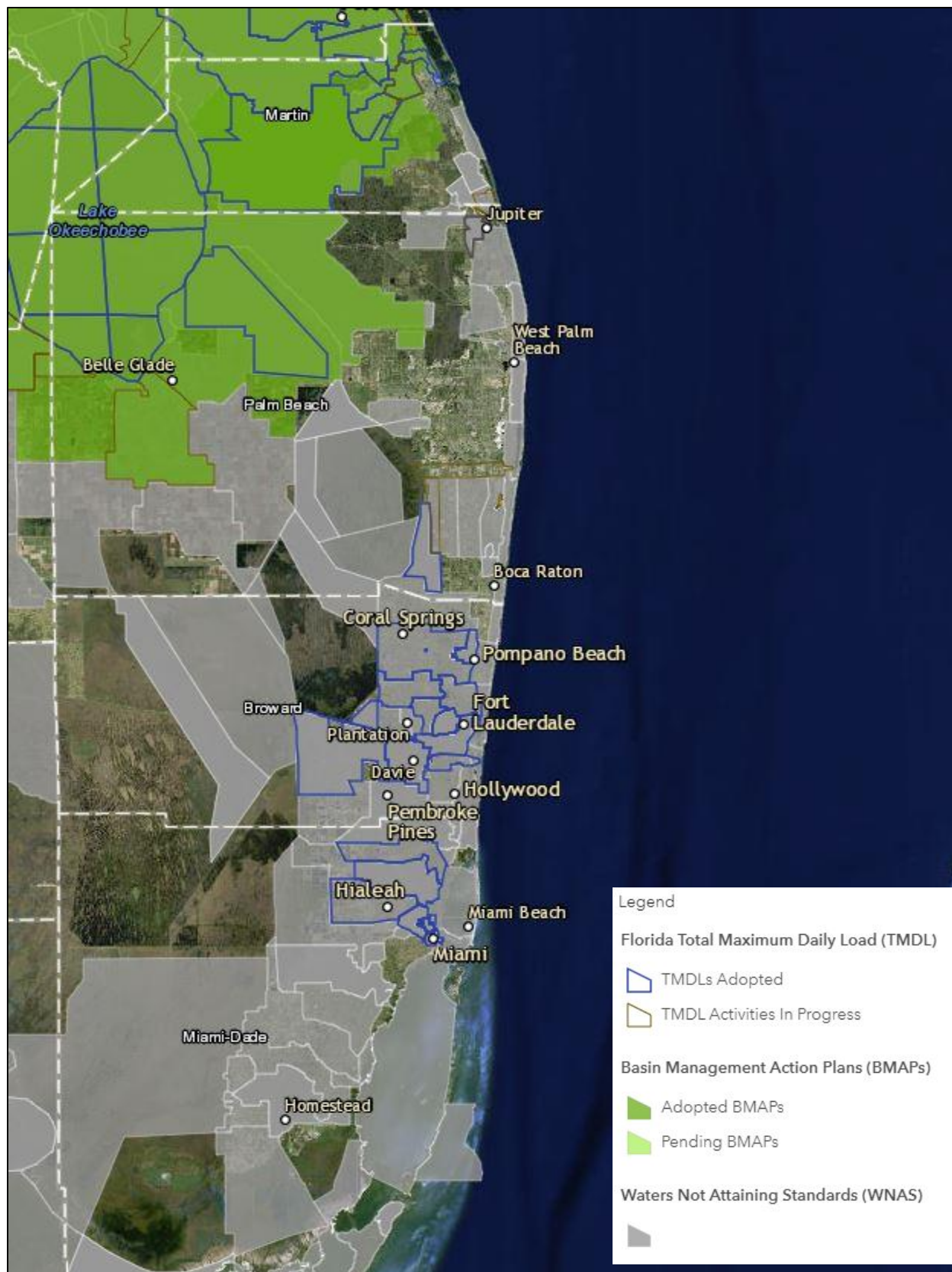

Figure 2-13. Impaired waters with existing TMDLs and BMAPs.

2.3.3. Regional - South Florida Water Management District

ENVIRONMENTAL RESOURCE PERMITTING (ERP) PROGRAM

The ERP governs most activities that relate to stormwater discharge into receiving bodies. It covers land disturbances that are smaller than the NPDES area threshold, which essentially means anything less than 1 acre but impervious and semi-impervious areas greater than 4,000 ft² with vehicular traffic or greater than 9,000 ft² without traffic. The permit is also an FDEP program that is delegated to the Water Management Districts and some local governments. The Environmental Resource Permit Applicant's Handbook, Volume I contains an overview of the statewide program, administrative procedures, and types of permits. This information is common throughout the state, but information specific to South Florida Water Management District is found in the Applicant's Handbook Volume II. Volume II includes design criteria and methodologies related to stormwater quantity and quality, as well as for the design and construction of some stormwater control structures (SCMs). These SCMs are discharge structures and flow control devices/bleed-down mechanisms for detention systems, retention systems, wet detention systems, and exfiltration systems.

ADMINISTRATION OF THE ERP PROGRAM

The FDEP delegates the administration of ERPs to the Water Management Districts. Requirements to obtain an ERP in South Florida are contained in the South Florida Water Management District's (SFWMD) Publication, Environmental Resource Permit Applicant's Handbook, Volumes I and II. The latest edition was effective May 22, 2016 and has been adopted by reference in Chapter 62-330 F.A.C.

The water management districts set the required minimum treatment volumes (MTV) that each type of SCM must meet, unless a local government has more stringent requirements. The stormwater SCM designs are based on performance criteria in some instances and are based on a presumptive criteria in others, meaning that if SCMs are permitted, constructed, operated, and maintained, according to the specified criteria, stormwater quality is presumed to meet Florida's surface water standards. To be approved, an applicant for an ERP must provide calculations to show that the proposed SCM or combination of SCMs will treat the applicable MTV.

Individual projects can apply for approval of different criteria if it is shown to be effective. The SFWMD Environmental Resource Permit Applicant's Handbook states, "The quality of stormwater discharged to receiving waters is presumed to meet the surface water standards in Chapters 62-4 and 62-302, F.A.C., and the groundwater standards in Chapters 62-520 and 62-550 F.A.C., if the system is permitted, constructed, operated and maintained in accordance with Chapter 62-330, F.A.C., and Part III, Part IV, and Part V of this Volume. However, this presumption is rebuttable. The volume of runoff to be treated from a site shall be determined by the type of treatment system."³⁶

The SFWMD suggests typical protective measures for stormwater, including pollutant source controls, conveyance and pretreatment, and enhancements for water quality treatment. They do not specify design criteria for most LID treatment measures. Although SFWMD does not exclude the use of other measures not listed, as a practical matter, the extra cost of design, documentation, and permitting time, as well as the risk that a design will be non-compliant are currently significant barriers to the use of alternative LID SCMs. Local governments may develop specific requirements to help overcome these

³⁶ South Florida Water Management District. (2016). *Environmental Resource Permit Applicant's Handbook Volume II*. Retrieved from https://www.sfwmd.gov/sites/default/files/documents/swerp_applicants_handbook_vol_ii.pdf

barriers using general information in this manual in addition to more detailed design procedures from other sources. The design criteria recommended in this manual are general guidelines currently being used in one or more Florida counties, such as: [Duval](#), [Escambia](#), [Pinellas](#), [Sarasota](#), and [Alachua](#). These Stormwater/LID manuals also provide detailed design criteria, procedures, and design examples for many SCMs. The procedures can be modified for use in Southeast Florida with regional data (mean-annual values) found in the Draft Statewide Stormwater Applicant’s Handbook. Specifically, this data covers local rainfall, event mean concentrations based on land use, runoff coefficients, and mass removal efficiencies. Removal efficiencies are found in tables based on the available/specified retention volume for each sub-area, its percent of directly connected impervious area (DCIA) and a composite curve number for all remaining areas, which is described as non-directly connected impervious area (NDCIA CN).³⁷

2.3.4. Local government regulations

Local governments produce land development codes or comprehensive development master plans to govern design regulations and policies that affect stormwater and pollutant management. These documents set out objectives and policies that may place further restrictions on land use, requirements for open spaces, conservation practices to protect sensitive lands, and construction methods.

For example, Miami-Dade County’s GreenPRINT plan, adopted in 2010, sets aspirational goals that include items consistent with LID without addressing specific stormwater and pollutant policies. Some of these goals are to “Prevent degradation of Outstanding Florida Waters, restore and enhance more than 500 acres of coastal habitats and wetlands, and preserve more than 24,000 acres of environmentally endangered lands.” The plan also includes land use planning emphasizing walkable communities and green spaces.³⁸

A number of South Florida municipalities have also adopted some form of “Complete Streets” guidelines or manuals. These may be optional, recommended practices or they may be requirements. Complete Streets guidelines typically include many design features that are consistent with nonstructural LID/GI, but they often do not specifically address stormwater quality or management.

2.4. Local Case Studies

2.4.1. Innovative stormwater management/water treatment

Examples of innovative stormwater management or water quality improvement projects in Southeast Florida are found on both private and public land and range in scale and expense.

SEMINOLE SCULPTURAL BIOFILTRATION WALL, COCONUT CREEK

The Seminole Coconut Creek Casino incorporated a 40-foot high sculptural wall in a courtyard that employs multiple levels of aquatic gardens to filter, aerate, and remove nutrients from the site’s stormwater. Rainwater is harvested from the roof, stored in a retention pond, and pumped to the top of

³⁷ Messer, N. (2010, March). *March 2010 draft stormwater quality applicant’s handbook*. Florida Department of Environmental Protection and Water Management Districts. Retrieved from https://fdotwww.blob.core.windows.net/sitefinity/docs/default-source/content2/roadway/drainage/files/stormwaterqualityapphb-draft.pdf?sfvrsn=579bf184_0

³⁸ Miami-Dade County. (2010). *Green Print: Our design for a sustainable future*. Author. Retrieved from <http://www.miamidade.gov/greenprint/pdf/plan.pdf>

the wall, where it cascades down through the gardens. The system is capable of treating about 150,000 gallons of stormwater per day. Photovoltaic solar power is used to run the pumps and supplement other electrical demands on the site. A display board explains the process and its purpose for the public. The system provides a good example of blending stormwater treatment, public education, and art (Figure 2-14).³⁹

LAKE WORTH LAGOON INITIATIVE

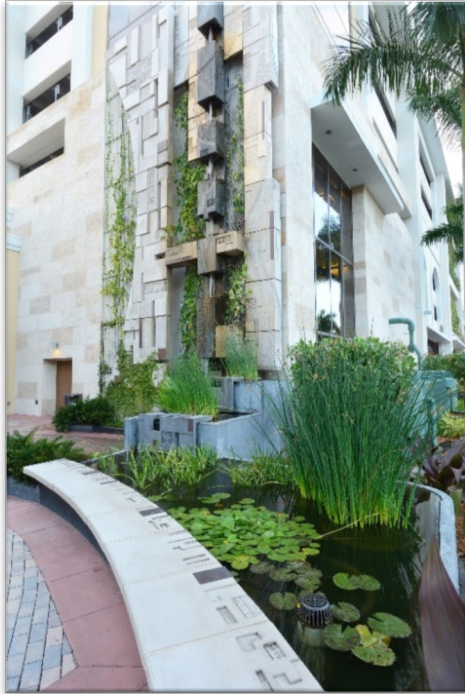

Figure 2-14. *Seminole sculptural biofiltration wall*



Figure 2-15. *Living shoreline mangrove planter in Lake Worth Beach. (Photo: Michael Singer Studio)*

The Lake Worth Lagoon Initiative has worked to restore the lagoon's natural habitats and improve water quality, which had been degraded by human development. The lagoon is part of the Intracoastal Waterway. A series of projects have created tidal saltmarsh and mangrove islands, sandy flats, seagrass beds, and oyster reefs. The first of these was the Snook Islands Natural Area, completed in 2005, where 100 acres of estuarine habitats were restored, creating four islands and 1.2 linear miles of natural shoreline. Mangroves and salt marshes were planted to restore shallow sub-tidal habitats, and public use amenities were built.⁴⁰

Living shorelines also are used to improve water quality and attenuate wave energy to reduce erosion and damage from storm surges. Partially funded by the National Endowment for the Arts, a prototype living shoreline mangrove planter in Lake Worth Beach incorporates a semi-circular planter for

³⁹ Michael Singer Studio Sculptural Biofiltration Wall. Retrieved from <https://www.michaelsinger.com/project/seminole-sculptural-biofiltration-wall/>

⁴⁰ Palm Beach County Board of County Commissioners Department of Environmental Resources Management. (2015, January). *Snook Islands Natural Area: A Lake Worth Lagoon restoration project*. [Brochure]. West Palm Beach: Author. Retrieved from <http://discover.pbcgov.org/erm/Publications/SnookIslandsRestoration.pdf>

mangroves, a shelf for oyster habitat, an adjustable fish passage, and a sculptural wall to attenuate waves and protect the shoreline (Figure 2-15). After the mangroves become well-established, the design allows the concrete structure to be moved to a new location and reused. If used in large numbers, the installed construction costs are expected to be less than riprap.⁴¹

MIAMI BEACH STORMWATER MANAGEMENT MASTER PLAN

The Miami Beach plan for stormwater management, adopted in 2011, attempts to look ahead and incorporate future sea-level rise and could serve as a model for other communities to follow. Most new stormwater infrastructure is designed to accommodate a 20-year SLR, and sea wall elevations are set to expected 50-year levels. The planned improvements are expensive: up to \$500 million over five years to install 80 stormwater pump stations to drain streets and raise some roads and sidewalks by 1.5-2.0 feet. In addition, the plan recommends stormwater harvesting and reuse, swales and exfiltration trenches for infiltration, and injection wells to recharge surficial aquifers. It is intended to be reviewed and modified every five years to adjust for uncertainty in projected SLR. The city uses education and “good-housekeeping” to reduce the level of pollutants entering the system and filtration to treat runoff.⁴²

VACUUM SEWERS IN SEWELL’S POINT, MARTIN COUNTY

Martin County has been converting septic systems to sewers since the 1990s, converting 1,762 properties in eight separate projects. A new project began in 2017 to make new connections using a vacuum sewer system. Sewell’s Point is located on a spit of land between the St. Lucie River and the Indian River Lagoon. Low elevations in some areas mean there may be insufficient depth above the water table for onsite systems to function well. With the new vacuum system, individual neighborhoods will be connected to the county’s central sewer system using grinder pumps at each residence and relatively inexpensive small diameter sewer lines.

2.4.2. Improved Water Quality

Water quality and overall seagrass acreage in the Lake Worth Lagoon have improved in response to the Palm Beach County’s habitat restoration efforts over more than 20 years.⁴³ When development began in the early 1900s, the natural shoreline was filled and seawalls were built, interfering with the filtration and treatment that the native wetlands and coastline had provided. By mid-century, odors from sewage had developed and residents avoided the lagoon. Undoubtedly, improved waste water treatment, as well as restoration of areas where deep holes had been dredged for fill, have improved water quality in the lagoon. Healthy seagrass, mangroves, salt marshes, and oyster reefs have been restored and are now attracting a variety of fish, birds, and other wildlife back to the area. Further, ecotourism businesses have been operating in the lagoon in recent years.⁴⁴

⁴¹ Living Shoreline Seawall Renewal West Palm Beach. (n.d.). Retrieved from <http://www.michaelsinger.com/project/living-shoreline-seawall-renewal/>

⁴² Strowd et al. (2017). *Regional impacts of climate change*.

⁴³ Lake Worth Lagoon Initiative. (2013). *Lake Worth Lagoon Management Plan*. Retrieved from <http://discover.pbcgov.org/erm/Publications/LWLmanagementplan.pdf>

⁴⁴ Meszaros, J. (2015, February 5). Lake Worth Lagoon’s ecotourism increases as water quality improves. Retrieved from <http://www.wlrn.org/post/lake-worth-lagoons-ecotourism-increases-water-quality-improves>

3. SITE PLANNING

With an understanding of *why* LID/GI strategies offer promise for reducing, managing, and mitigating the effects of LBSP relative to conventional approaches (Chapter 1); *what* some of the key contextual factors are of Southeast Florida’s hydrogeology, unique challenges, and external stressors; and the regulatory framework influencing the suitability and effectiveness of LID/GI approaches (Chapter 2), the next sections of this manual delve into the *process* of initial site planning and assessment of suitability for LID/GI SCM applications. In site planning, decision-makers will need to consider two fundamental questions related to LID/GI potential and gather enough information to document a comprehensive picture of the site constraints, opportunities, and unique considerations.

1. *What are the history, current status, and unique features of the site or focus area?*
2. *How do previous and existing land use designations limit and/or support certain design opportunities?*
3. *Are there certain “high-value” environmental or natural resource features of the site that inherently support source control, capture, infiltration, conveyance, storage, and/or treatment of upstream and/or on-site pollutant loads?*
4. *What are the primary pollutants of concern generated by the site, and how do these pollutants move through the site to receiving water bodies? How do they affect ecosystems and the quality of natural resources along the way?*
5. *What is the range of specific opportunities for protecting and enhancing site assets and pollutant control processes as the site is developed, redeveloped, and/or managed over time?*

Key take-home messages include:

- While new “greenfield” development typically presents the greatest range of opportunities for integration of LID/GI measures, sites with different land uses being redeveloped, retrofit, and managed to reduce LBSP can still be well-suited for design features consistent with LID/GI goals.
- When assessing a site, fundamental LID tenets such as disconnecting impervious areas, retaining stormwater onsite, and using an integrated “treatment train” approach should all be considered to leverage existing site assets.
- A thorough inventory and mapping of site features prior to design and construction can reveal potential source control and stormwater assets that should be preserved and might be enhanced through the integration of LID/GI measures. A number of tools have been developed to estimate the economic value of ecosystem features and functions.
- Three broad frameworks can be used to guide initial site planning:
- Implement established ecological principles where possible to preserve natural areas, protect surface waters, and conserve, restore or enhance significant lands, aquatic habitats, and ecosystem functions.
- To the extent feasible, maintain or replicate pre-development drainage patterns and hydrologic functions.
- Promote soil health and infiltration capacity by minimizing compaction of soils and uniformity of topography.

3.1. Site Assessment

LID/GI projects require a thoughtful and holistic approach to SCM site selection and evaluation. The goal is to prevent or minimize adverse site and water impacts at the source rather than treat them after the fact. Preserving site attributes and integrating stormwater management treatment trains require early planning and should never be an afterthought or simple “add-on” to a conventional design. Developers and project engineers are encouraged to first define the project to be consistent with LID, then plan the entire site, and design the stormwater management system to incorporate LID principles and practices as much as possible.

3.1.1. Categorize existing and future land use: identify potential constraints

The first step in conceptual site planning is to examine the existing land use and consider whether and how it constrains the choices available for site planning and stormwater management. Ideally, LID/GI is most effective when used during the initial development of greenfield sites. During that initial phase, the natural hydrology can be easily seen, slopes and depressions can be used to manage runoff, and it may be possible to avoid compacting soils in areas designated for infiltration. In previously developed locations, some of the basic LID tenets can still be used, including disconnecting impervious areas, retaining some stormwater onsite while slowing and spreading runoff, and using a treatment train to remove pollutants.

However, on redevelopment sites, the options for overall site design and stormwater treatment may be constrained by previous development choices. For example, if structures and pavement cover the majority of the site, it may be possible to detain and treat stormwater with pervious pavement and/or street trees and infiltration planters.

Retaining some stormwater onsite may eliminate the need to increase stormwater pipe sizes and may reduce the area needed for flood control or treatment ponds. Developers may be able to save money on road and landscaping costs, and property values have been found to increase with closer proximity to green spaces. Cost/benefit estimates for initial planning can be done with online tools, such as the Green Values National Stormwater Calculator at <http://greenvalues.cnt.org/national/calculator.php> or the University of Central Florida tool, [BMPTRAINS](#).

3.1.2. Identify high-value environmental resources and low-value site areas

A thorough inventory of all site features focused on maintaining hydrologic functions, is an important early step to take before buildings, roads, and other infrastructure are located. Inventory important vegetation and wildlife on the site, both desirable and undesirable, and note whether any plant or animal species are endangered or threatened and exotic or invasive. An overall goal of the LID planning stage is to maintain or replicate original site hydrology, meaning that predevelopment surface runoff rates and volumes, infiltration, evapotranspiration, and hydrologic assets of the site are maintained or replicated through onsite environmental enhancement and mitigation as much as possible.

Inventory important vegetation and wildlife on the site, both desirable and undesirable, and note whether any plant or animal species are listed as endangered or threatened and exotic or invasive.

As design options are evaluated in these early phases, consider not only the immediate short-run costs of building and stormwater infrastructure, but also the long-term costs (and benefits) of alternative design to the

developer/builder, the property owner and to the municipality and larger region. Thoughtful planning and cost analysis can balance the benefits of upfront construction and long-term operation and maintenance.

3.1.3. Identify pollutants of concern and their sources

An understanding of what pollutants are likely to be in the stormwater, the processes needed to remove them, and the SCMs available to provide those processes is needed for appropriate design. The most common pollutants in stormwater are sediment, nutrients (nitrogen and phosphorus), heavy metals (zinc, nickel, lead, chromium, cadmium, and copper), coliform (potentially pathogenic) bacteria, pesticides, and organic pollutants (gasoline and oils).

Sediment picked up and transported by stormwater usually settles in treatment ponds or other SCMs that slow the water velocity. Resuspension can occur under some conditions and is particularly common in swales that experience a wide range of velocities. Therefore, provisions for periodic removal of accumulated sediment must be part of SCM routine maintenance.

Excess nutrients, a main focus of stormwater treatment, are contained in and released through decomposition by all organic material but are at much higher concentrations in fertilizers and reuse water applied to our lawns, public landscaped spaces, and agricultural areas. Sedimentation and filtration—the main treatment mechanisms of conventional stormwater treatment ponds do not remove dissolved form of nutrients. Chemical and biological processes are required to remove these dissolved nutrients.

PHOSPHORUS

Phosphorus (P) is often the growth-limiting nutrient in fresh surface water systems. Any increase in phosphorus concentration is likely to result in increased algal growth of macrophytic plants, phytoplankton, and algae. The higher concentrations of phytoplankton and algae decrease water clarity and limit sunlight penetration into waterbodies. Dissolved oxygen in the water is lowered as it is consumed by decomposers processing the plant matter as they die off. The resulting hypoxic conditions can harm or kill aquatic life, creating dead zones that are increasingly common in aquatic and coastal areas worldwide.

Phosphorus occurs in organic or inorganic forms and can be either dissolved or found bound to suspended particulates. Dissolved phosphorus can be at least partially removed by plants in contact with the water or by flowing through appropriate soil or media, and particulate phosphorus can be removed by sedimentation and filtration. However, the solubility of phosphorus varies with pH, temperature, and the availability of oxygen (e.g., a pH of 6.5 corresponds to maximum solubility). Changes in any of these conditions can convert previously settled particulate phosphorus into its dissolved state, and decomposing plant material can release formerly dissolved phosphorus again into the water. Either of these situations cause treatment ponds and wetlands to eventually act as a phosphorus source rather than as a sink, releasing the stored nutrient into the water column and potentially to downstream receiving waters. Therefore, the amount of phosphorus removed varies considerably in stormwater treatment systems and can vary in the same system over time. Periodic sediment removal and harvesting of plant growth is necessary to reliably remove phosphorus from stormwater. Forebays at the entrance points (inlets) to treatment ponds support sedimentation and allow simplified sediment removal.

NITROGEN

Nitrogen (N) exists in several forms in the environment: ammonia (NH_3), nitrite (NO_2), nitrate (NO_3^-), or nitrogen gas (N_2). Fertilizers (from urban users and agricultural applications), wastewater, and decomposing organic matter are sources of ammonia, which is broken down by microorganisms in the soil. If oxygen is available (aerobic conditions), ammonia will be converted to nitrite, and then into nitrate in a process called nitrification. Nitrification typically occurs in shallow water bodies, as well as in soil. Nitrate is highly soluble and not removed by sedimentation or sorption mechanisms, so excess nitrates can be carried into surface or groundwater.

Elevated nitrate levels are considered pollutants for several reasons. In humans, concentrations greater than 10 mg/l can cause serious health problems, especially for infants. Few places have nitrate concentrations high enough to cause health concerns, but increasing levels to much lower concentrations can cause significant problems in natural water systems. Because plants readily take up N in the nitrate form, aquatic plants and algae grow more readily when excess nitrates are present. The extra growth often clouds springs and contributes to eutrophication and harmful algal blooms. Nitrogen levels are often elevated by septic system effluent, reuse in fresh and salt water, runoff, agricultural wastewater and fertilizers – both urban users and agricultural applications.



Figure 3-1. Decomposing plants release nitrogen stored in their tissues.

Two primary processes remove nitrates from water: (1) uptake by plants in wetlands or other vegetated areas, and (2) denitrification. Absorption by plants, therefore, is an effective means of removing N before it can lead to unwanted aquatic growth downstream. However, aquatic vegetation must periodically be removed from treatment wetlands and ponds or other bioretention areas before it decomposes and releases its nitrogen back into the environment. Uptake is one of two primary processes to remove nitrates from water.

The second process to remove nitrates is termed denitrification, a chemical reaction that occurs under anoxic conditions in the absence of oxygen. During denitrification, nitrates are converted to nitrogen gas, primarily dinitrogen [N_2], although nitric oxide [NO] and nitrous oxide [N_2O] can also be formed by

specific types of bacteria under low oxygen conditions.⁴⁵ These conditions occur in deeper portions of retention stormwater ponds or other zones that remain saturated for extended periods. Denitrification is an important part of a treatment train design, as it is the only method of permanently removing nitrates from stormwater.

METALS

Metals also enter water through various everyday sources. Stormwater is the source of 80%–95% of heavy metals in Florida’s surface waters.⁴⁶ Most of these metals, including lead, zinc, cadmium, copper, and nickel, enter stormwater from our cars: degradation of tires, engine parts, and brake linings and leaks of motor oils, grease, and other lubricants. These substances are deposited on roadways as cars leak or tires wear down and are carried off by stormwater. Insecticides and fungicides also may contain copper and cadmium. Some wetland vegetation is effective at removing heavy metals. Heavy metals can also be removed through sorption by filtering stormwater through certain types of vegetative mats with high lignin content, such as alfalfa or aspen fibers.⁴⁷

ORGANIC POLLUTANTS

Organic pollutants such as oil, gasoline, and other hydrocarbons are usually removed and biodegraded during infiltration because they have a high affinity for soil and mulches. Hydrocarbons can also be degraded by sunlight and bacteria in standing water bodies.

If the major sources of nutrients or other pollutants at a site are identified, it may be possible to minimize their entry into the stormwater system and lessen the subsequent need for treatment. For example, regular street sweeping can remove sediment with adsorbed metals, reducing the amount entering storm drains. Education campaigns for property owners and landscaping companies to not over-use fertilizers and avoid spreading them onto paved areas, as well as to pick up grass cuttings, can prevent these nutrient sources from going into the stormwater system.

3.2. Site Resource Protection

Site resource protection is particularly important for greenfield development but has application for redevelopment in locations near water bodies and other natural features. In urban areas, stormwater management to protect significant buildings or historical locations may be needed.

⁴⁵ Blaszcak, J. R., Steele, M. K., Badgley, B. D., Heffernan, J. B., Hobbie, S. E., Morse, J. L., ... Bernhardt, E. S. (2018). Sediment chemistry of urban stormwater ponds and controls on denitrification. *Ecosphere*, 9(6), e02318. <https://doi.org/10.1002/ecs2.2318>

⁴⁶ Huang, X., Lin, Z., & Jia, Y. (2007). *Estimating the spatial distribution of stormwater best management practices in the St. Johns River Water Management District*. Palatka, FL: St. Johns River Water Management District. Retrieved from <ftp://secure.sjrwmd.com/technicalreports/SP/SJ2007-SP20.pdf>

⁴⁷Han, J. (1999, September). Stormwater filtration of toxic heavy metal ions using lignocellulosic materials selection process, fiberization, chemical modification, and mat formation. In A. Musy, L. Santos Pereira, & M. Fritsch (Eds.), *Emerging technologies for sustainable land use and water management: Proceedings of 2nd Inter-Regional Conference on Environment-Water*. Lausanne, Switzerland: Presses Polytechniques et Universitaires Romandes. Retrieved from <https://www.fpl.fs.fed.us/documnts/pdf1999/han99a.pdf>

3.2.1. Preserve natural areas, protect surface waters, and conserve significant lands and aquatic habitats

Not all sites contain natural areas that can be preserved, but where they exist, several established ecological principles should be considered when initially laying out development and setting aside open spaces.

- Reduce the length of edges between the development and natural area. Edges have greater disturbance, more predators, and poorer habitat for many species. The effective width of an edge varies for different species but can extend 150-300 feet into natural areas.
- Single, roughly circular shapes are preferable for natural areas, rather than the same total area divided into several smaller patches or spread into a long narrow strip of land.
- Patches with “soft” edges (gradual and undulating vegetation) are better than those with “hard” edges (straight and sudden; e.g., pavement or lawn up to a tree line)
- Where there are several patches of natural habitat, a wildlife corridor to connect them is desirable. This connectivity works to expand the functionality of natural areas for wildlife habitats.
- If a site contains wet and dry areas, both should be included in preserved areas.
- Preserve rare natural communities over more common ones using the [Florida Natural Areas Inventory](#) state and global rarity rankings.
- Tree canopies have the potential to intercept approximately 15-20% of rainfall on their leaves, making them important resources for stormwater source control. Existing canopies of native trees should be retained where possible, and plantings to develop future canopies are desirable. Native trees and other native vegetation are especially important to retain, as they tend to have better root systems and are better adapted to local climate extremes. Native plants also require less supplemental irrigation and fertilizer inputs, reducing nutrient loads into surface and groundwater.
- When existing trees are retained, protecting the critical root zone from grade changes is essential to avoid killing the tree. A change of even a few inches can have significant harmful effects. Similarly, soil compaction in the root zone of a tree collapses voids in the soil and greatly reduces



Figure 3-2. Avoid complete site clearing.



Retain trees where possible.

the amount of water that can infiltrate. This can deprive the tree of adequate water and oxygen it needs to survive.

If the site contains water bodies, karst features, desirable wildlife, or cultural areas that may be impacted by direct runoff into them, vegetated buffer strips should be used to protect them. Minimum buffer distances vary by the type of surface water: a minimum of 35 feet and an average of 50 feet should be used for waters less than 0.5 acre with no special designation, increasing to a minimum of 100 feet with an average of 150 feet for Outstanding Florida Waters. Properties bordering large manmade wet basins should have a minimum of 30 feet of non-turf native plantings on the water's edge.

Some Florida counties allow stormwater credit for natural areas if they remain undisturbed during construction and are protected by a permanent conservation easement that prescribes allowable land uses and prevents future development. This could apply to any areas of undisturbed vegetation preserved on the development site, including floodplains and riparian areas and stream, wetland, and shoreline buffers. The following guidelines⁴⁸ are recommended for areas to be designated as permanent conservation land:

- The natural area should be at least one acre in size; a group of smaller areas may be combined.
- The area must remain undisturbed, except for restoration operations or removal of exotic vegetation.
- Construction drawings must clearly show the limits of disturbance around each conservation area.
- A long-term vegetation management plan must be prepared to maintain the conservation area in a natural vegetative condition. Managed turf is not considered an acceptable form of vegetation management, and only the passive recreational areas of dedicated parkland are eligible for the credit (e.g., ball fields and golf courses are not eligible).
- A perpetual easement must be filed in the public records before construction begins.

3.2.2. Evaluate source control options

A good standard of practice for managing pollutant loads from any upland site is to start with source control. Typically, the least costly approaches to managing and mitigating land-based sources of pollution begin at the source: managing stormwater as far upstream as feasible with retention where possible.

ONSITE RETENTION

Any volume of stormwater that can be retained onsite and infiltrated into the soil or reused reduces the need for infrastructure to transport and treat stormwater as it moves downstream, as well as reducing the need for irrigation. Treatment through distributed retention is the most effective and perhaps the most cost-effective means of removing pollutants. It is possible to reduce the size of stormwater pipes and treatment ponds if adequate distributed retention can be provided through methods such as bioretention, infiltration cells, or pervious pavements.

⁴⁸ Wanielista, M. P., & Livingston, E. H. (2016, September). *Escambia County LID BMP Manual*. Retrieved from https://myescambia.com/docs/default-source/sharepoint-natural-resources-management/Water%20Quality%20Land%20Management/lid/escambia-county-lid-manual_final_9302016.pdf.

FLORIDA-FRIENDLY LANDSCAPING™

Developers and builders make landscaping decisions for the public that effectively determine not only the type of plants in their landscapes, but also often lock them into applying water, fertilizer, and pesticides for many years to maintain those landscapes. It is important for our future water quality that our landscapes change from requiring high levels of inputs to those requiring fewer resources. Native plants or those well adapted to the climate and soil conditions where they will be planted can save large amounts of irrigation water and fertilizer as well as time and expense for upkeep. Native plants also provide food for wildlife.

3.2.3. Maintain natural drainage pattern, hydrologic balance

Identify and maintain the predevelopment hydrology to the maximum extent possible. Consider predevelopment surface runoff or sub-surface flows, infiltration, and evapotranspiration and hydrologic assets of the site. Natural depressions should be maintained where possible to promote storage, infiltration, and treatment during typical stormwater events and to capture the “first flush” of stormwater during extreme events. The first flush is the initial runoff when rainfall begins. It usually has higher concentrations of pollutants that have accumulated on the land during dry periods.

Several questions should be considered at this point in the planning process.

- Does stormwater from adjacent properties enter the site or carry significant pollutant loads? Diversion of the flow or pre-treatment on the neighboring site may be options to consider.
- Is there potential for sinkhole formation or stream bank erosion? Although sinkholes are less common in Southeast Florida than much of the state, [they do occur](#) and are more likely to form when flow is concentrated in a small area. Increased pressure from the storage of large volumes of stormwater can also accelerate the process.
- Is there potential for erosion on the site? Both peak runoff rates and the total volume of runoff can contribute to erosion. Greater volumes of runoff can change the hydroperiods of streams and their aquatic communities.

3.2.4. Soils and infiltration

HYDROLOGIC SOIL GROUPS (HSG)

The USDA Natural Resources Conservation Service classifies soils into four broad categories that indicate their relative hydrologic function. Hydrologic Soil Groups (HSGs) are categorized according to the infiltration rate of water when the soils are thoroughly wet and receive precipitation from long-duration storms. Group A soils are generally well-drained, deep sands with high infiltration rates and low runoff potential. These soils also have a high rate of water transmission. Retention BMPs work very well on HSG A soils. Retention BMPs also work well on Group B soils that have a moderate infiltration rate and moderate rate of water transmission. Group C soils have a slow infiltration rate when thoroughly wet and consist primarily of fine textured soils with a slow rate of water transmission. Group D soils have very slow infiltration and water transmission rates. These soils generally have a high clay component and high runoff potential.

The classifications A/D, B/D, and C/D indicate that although the surface of the soil corresponds to the first letter designation, a barrier below the surface prevents longer term transmission, so when saturated they

behave like D soils. For example, the barrier may be a clay layer, but it more commonly indicates the presence of a high water table. Table 3-1 summarizes the characteristics of the HSG classifications.

Table 3-1. Characteristics of NRCS Hydrologic Soil Groups

Hydrologic Soil Group	Infiltration Rate		Water Transmission Rate	Runoff Potential
	When Dry	When Wet		
A	High	High	High	Low
B	Moderate	Moderate	Moderate	Moderate
C	Slow	Slow	Slow	High
D	Very Slow	Very Slow	Very Slow	Very High
A/D	High	Slow	Variable	High
B/D	High	Very Slow	Variable	Very High
C/D	Moderate	Very Slow	Variable	Very High

MINIMIZE SITE DISTURBANCE AND SOIL COMPACTION TO MAXIMIZE INFILTRATION

The fertility, infiltration capacity, extent of compaction and stability of native soils will constrain the landscape design and management plan to varying extents. All LID projects should attempt to minimize adverse impacts of development on soils. Preserving existing vegetated areas and protecting soils that will eventually have vegetation or other pervious materials covering them is important for maintaining infiltration of these areas.

Compaction can have a greater impact on hydrology than the hydrologic soil group classification, and calculations of expected stormwater runoff may be significantly underestimated if the effects of compaction are ignored. Construction equipment has been found to reduce infiltration rates of sandy soils between 80 and 99%.⁴⁹

Compaction of the top 6 inches is primarily related to tire pressure, and compaction of greater depths is related to the total weight of the equipment. This affects primarily the top foot of soil, but some compaction continues up to 3 feet (Figure 3-3). Repeated loading is not necessary for damage to occur, as up to 80% of the total compaction can occur during the first vehicle pass. However, regular traffic during wetting and drying of the soil during construction provides optimum conditions to maximize compaction. Vehicles left idling on the site also transmit vibrations into the soil, facilitating greater compaction. The degree of compaction varies with the soil type, the pH, the organic and mineral content, and the moisture level. The upper layers of soil can recover, but some soils with high clay content have taken more than 40 years to recover.⁵⁰

⁴⁹ Bean, E. Z. (2010). Evaluation of retention basins and soil amendments to improve stormwater management in Florida (Doctoral Dissertation). Retrieved from http://etd.fcla.edu/UF/UFE0042035/bean_e.pdf

⁵⁰ Mark Clark, Stormwater Considerations in Residential Developments, PowerPoint presentation 1-17-09

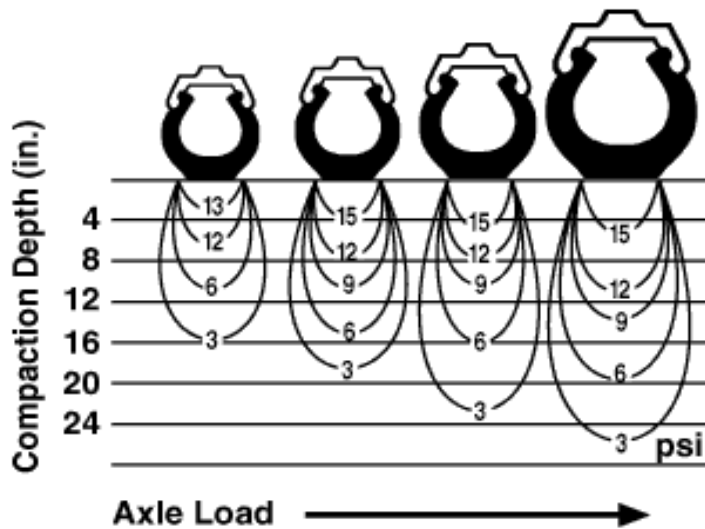

Figure 3-3. Depth of soil compaction varies with vehicle weight per unit area.

Trees and other vegetation struggle to survive if the soils in which they are planted have been excessively compacted. The ability for soils to accept and store water available for plants is reduced, and compaction limits root growth and the volume of soil from which plants can pull water. Although any compaction of soils that occurs during site preparation and construction should be mitigated through to restore some permeability and infiltration capacity, most soils cannot be returned to their natural state. However, conventional amending and compaction mitigation methods are generally limited to the top 6–12 inches of soil. **Avoiding compaction is far more preferable and less expensive. It is imperative that sites intended for infiltration SCMs be clearly designated and not traversed by heavy construction equipment.**

4. PLAN FOR STORMWATER CONTROL MEASURES

Initial site planning will document the scope of LID/GI features, functions, and opportunities on a site or for a specific project from multiple perspectives: asset retention and enhancement, pollutant-specific strategies, and treatment-train approaches (Chapter 3). Once this site canvas has been completed, the next phase is to plan the overall SCM design, which requires exploring the following questions:

1. *How can the concurrent yet potentially conflicting goals of flood control and water quality protection be satisfied through a suite of integrated SCMs (including non-structural design options, onsite stormwater capture, storage and infiltration; improving treatment capacity of conveyance mechanisms; and design tailored to “downstream” treatment requirements)?*
2. *What are the specific pollutant treatment processes that can be applied and leveraged to meet LBSP reduction and water quality protection goals?*
3. *What are the core elements of a treatment-train approach to stormwater management, and where do specific SCMs fit into the treatment train?*

Key principles applicable when planning for SCMs include:

- Use of ecological and non-structural designs approaches, such as cluster development; smaller lot sizes; vertical construction/multi-story buildings to reduce development footprint and avoid disturbing sensitive areas; street design to reduce road widths, length, and directly connected impervious areas; eliminating curb-and-gutter or use of curb cuts; and installing landscape vegetation that does not require supplemental irrigation and fertilizer beyond establishment to survive.
- Selecting SCMs with unit treatment processes (hydrologic, physical, natural disinfection, chemical, and/or biological processes) most effective at removing the pollutants of concern on the site and coupling these with volume control measures designed to capture the “first flush” of runoff from a storm event.
- Distributing and integrating SCMs across a site using a treatment-train approach that optimizes each phase in the treatment train: source controls, development or neighborhood-scale structural SCMs, lot-level structural SCMs, and use of “offline” treatment where feasible.

4.1. Drainage and Treatment Planning: Stormwater Management

Effective stormwater management must satisfy multiple goals: control runoff in a safe, effective manner while trying to mimic natural hydrology, improve water quality by removing nutrients and a range of other pollutants that may be present to protect human health and aquatic habitats, and continue to function efficiently within a set maintenance schedule.

4.1.1. Ecological non-structural SCM design

A few strategies can have a large impact on protecting or degrading water quality. These are simple, but they must be planned for at the earliest conceptual stages of a development proposal. Attempting to incorporate these design aspects after the plan has been developed would have limited benefit and potential.

CLUSTER DEVELOPMENT

Clustering development on a smaller portion of a site is a very effective pollutant source control that can be used anywhere, but it is most common for mixed use or residential developments. Clustering

decreases individual lot sizes but retains green space for the community, while the gross development density remains the same. This results in multiple benefits that significantly reduce the overall environmental impacts of a project. By lessening the overall site disturbance, there is an opportunity to maintain natural areas and wildlife habitat, which may reduce the amount of wetland fill (Figure 4-1). Cluster design typically reduces the total length of roads, and therefore transportation infrastructure and fuel costs as well. This can result in significant cost savings for infrastructure. The total impervious area can be greatly reduced, lessening the amount of stormwater generated and the area needed for stormwater management infrastructure.

Mixed use development has additional benefits for the community by decreasing the travel distance to reach shops, restaurants, and recreational areas. Compact, walkable town centers are popular features in many communities and add to real estate values and improve the residents' wellbeing.

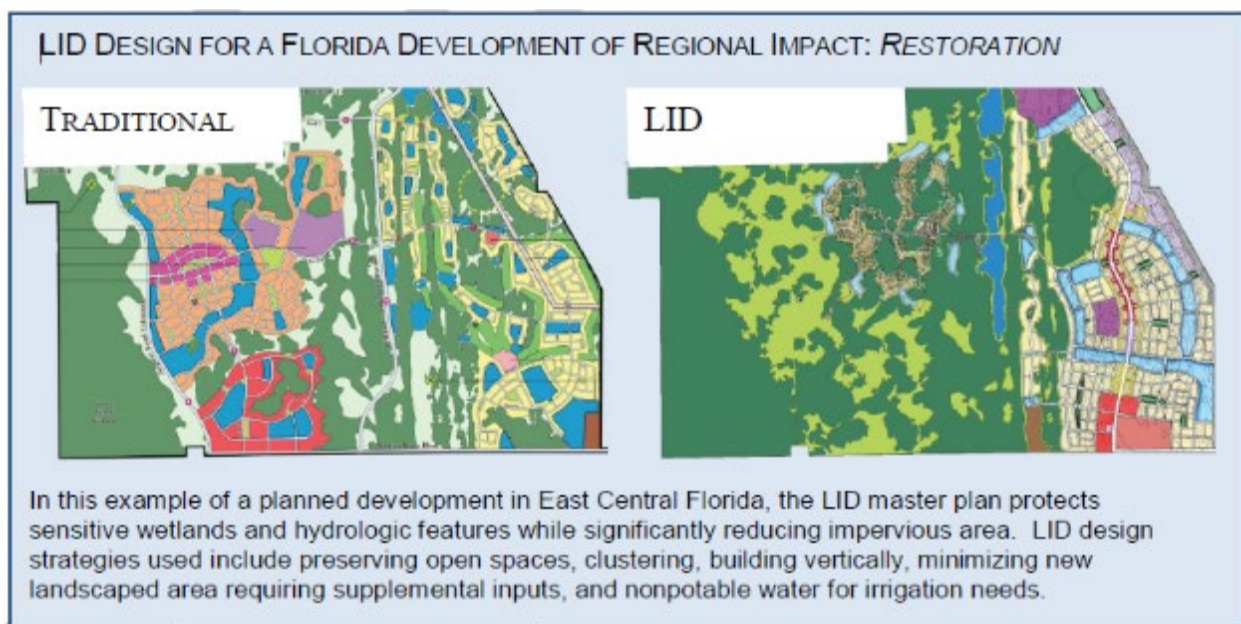

Figure 4-1. Traditional vs. LID designs for a large mixed-use community.

In commercial development, a form of clustering can be achieved by building multistory structures, reducing the overall footprint while retaining the same floor space as a more sprawling single-story building. The saved surface area can be left as a natural green space or it can be landscaped, creating an improved environment for all.

To encourage cluster development, zoning regulations based on gross density rather than lot sizes is needed. For example, clustering to increase density from 1 unit/acre to 4 units/acre, while maintaining the same total number of units, has been estimated to reduce the average annual stormwater runoff for the total site by 67%⁵¹. Total stormwater runoff from the entire site will be reduced, even though runoff from the more densely developed portion of the site may increase. Although homes in low-density

⁵¹ Richards, L. (2006). *Protecting Water Resources with Higher-Density Development* (No. EPA 231-R-06-001). U.S. Environmental Protection Agency's Development, Community, and Environment Division. Retrieved from https://www.epa.gov/sites/production/files/2014-03/documents/protect_water_higher_density1.pdf

developments may have large lawns, these areas have been disturbed, often regraded, and soils are usually compacted by construction that reduces their permeability. Retaining undisturbed land is the more effective option.

STREET DESIGN

Street layout can have a significant impact on the length of pavement needed, with grid patterns requiring the longest length while a design using loops and lollipops uses the shortest length. The difference (Figure 4-2) can be as much as a 26% savings in pavement, which will also reduce construction costs and the amount of stormwater runoff generated. Of course, these are not the only considerations, and walkable neighborhoods with shorter blocks that are created by connected streets are also desirable in urban areas. The pattern of a street network can affect safety, the distance travelled to reach a destination, and social connectedness of a community.⁵²

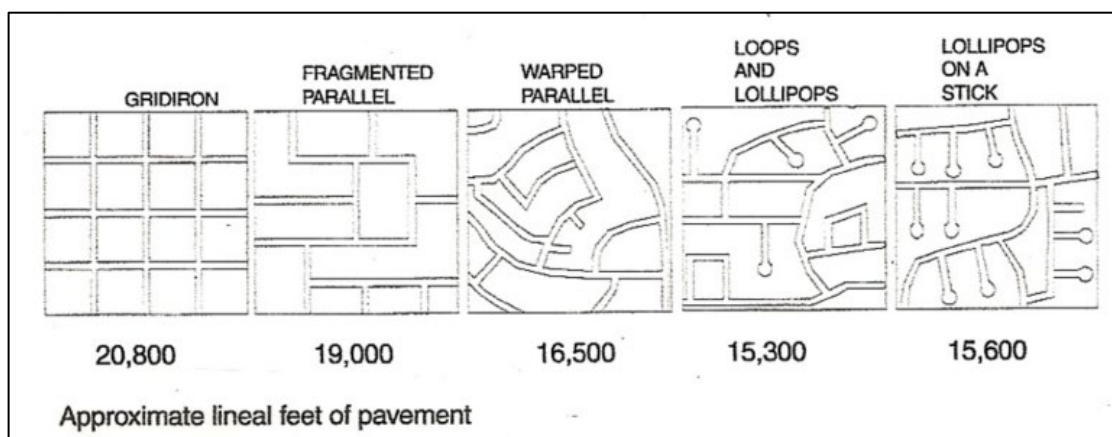

Figure 4-2. Pavement lengths with different road designs. (Graphic from Southworth, M. Ben-Joseph, E. (1997). *Streets and the Shaping of Towns and Cities*. McGraw-Hill.)

Pavement width is another consideration in street design. Impervious area may be reduced by narrowing street widths as much as possible. However, the need to accommodate the width and turning radiuses of emergency vehicles is a competing requirement that must be balanced. In some cases, additional width for emergency vehicle access and on-street parking can be met by incorporating pervious pavements on the outside of the main traffic lanes.

As with shorter lengths of roadway, narrower pavement widths generally reduce the amount of runoff, the volume required to treat the street runoff, and road construction costs. Narrow roads can be used for residential streets with traffic volume of 500 trips per day or less.

Finally, increased safety may be an ancillary benefit to narrower traffic lanes. While wider roads are often perceived to be safer and minimum widths may be required for emergency service vehicle access, narrower streets tend to cause drivers to slow down, as high speed increases the incidence rate of both pedestrian and vehicle accidents.

⁵² Zhang, Y., Wang, X., Zeng, P., & Chen, X. (2011). Centrality Characteristics of Road Network Patterns of Traffic Analysis Zones. *Transportation Research Record: Journal of the Transportation Research Board*, 2256(1), 16–24. <https://doi.org/10.3141/2256-03>

Curbs and gutters have long been standard features for roadways and parking lots, intercepting and directing runoff into drainage pipes in an efficient manner. However, they are often inconsistent with the goal of maintaining natural hydrology. Curbs concentrate runoff into faster flowing, more erosive streams of water. Simply eliminating curbs and allowing stormwater to drain in sheet flow from roadways onto vegetated areas or into swales slows runoff and reduces peak discharge rates (Figure 4-3). If used in conjunction with downstream infiltration BMPs, total stormwater volume is reduced.



Figure 4-3. Roadside swales replace curbs and gutters along a residential street. (Photo: UF PREC)

The first design decision is whether curbs are needed at all. If curbs are desired, eliminating stormwater inlets and piped conveyances can still be considered if runoff is directed to pervious areas through curb cuts. Curb cuts can be used in redevelopment and retrofit projects, as well. Whether gutters are required depends on how stormwater is being treated and managed downstream. Bioretention areas can be recessed into the center of cul-de-sacs.

LOT DESIGN

Impervious areas on individual building sites can be reduced by building vertically (2 or more stories) to decrease the building footprint, distributing floor space between two or more floors. Often, the width or length of driveways can be reduced, particularly if back alleys are used for vehicle access (Figure 4-4). In other locations, permeable pavement or pavers may be chosen for driveways and parking areas. However, permeable pavement is a structural SCM and requires regular professional maintenance, unlike the other passive measures described.



Figure 4-4. Small residential lots, multi-story buildings, and short driveways on back alleys reduce impervious areas.

SHARED COMMUNITY SPACES

Shared recreation facilities and community gardens are good alternatives to large individual residential lots. Residents may appreciate a greater variety of housing choices, the reduced maintenance needs of smaller lots, and the community atmosphere encouraged by shared facilities.

4.1.2. Understand site storage and conveyance opportunities and constraints

During initial site planning, several questions must be answered about the method of conveying and storing stormwater. Consider how stormwater will be moved across or through the site. Will it move as sheet flow or conveyed in swales or pipes? Can water be collected for onsite storage and detention? If so, what type of SCM is most suitable for storage? Where will high flows be discharged?

RETENTION/DETENTION

The terms retention and detention can be easily confused. With retention, the treatment volume is not discharged from the pond or other SCM to surface waters; it is retained and infiltrated into the ground, evaporates into the atmosphere, or is taken up by plants. Detention, on the other hand, holds back a certain volume of water for treatment but discharges it slowly to streams or other water bodies.

4.1.3. Identify receiving waters and determine treatment requirements

The type of treatment needed for a specific site will be dependent on water quality regulations, site land use, the pollutants present, the site's degree of imperviousness, soil type, space available for LID measures, and the designation of the receiving water body. Treatment train design starts with determining the total inputs and required final water quality, then sizing each SCM to meet the requirements.

Wet stormwater retention, dry detention ponds, and other traditional stormwater control measures have been permitted with a presumption of compliance, yet they often haven't solved water quality problems. Dissolved nutrients are particularly difficult to take out, since they are not removed with suspended solids and detention. LID SCMs place a greater emphasis on source control, biological removal, and

infiltration or treatment with reactive media that have the ability to remove greater amounts of dissolved nutrients.

4.2. Pollutant Treatment Processes

Pollutant treatment processes can effectively mitigate adverse water quality impacts. Controlling runoff is primarily accomplished by modifying a site's hydrology, that is, changing its response to rainfall, while the term "treatment" refers to improving the quality of stormwater runoff. A set group of unit processes underlie the ability to remove pollutants from water. These unit processes are found in all SCMs, often used in combination to treat stormwater.

4.2.1. Hydrologic processes⁵³

The most obvious effects of urban development on a region's hydrology are higher peak flow rates and increased total volumes of runoff that often lead to erosion and flooding downstream. The ubiquitous impervious surfaces of urban buildings, roads, parking lots, etc. prevent rain from soaking into the ground, and conventional drainage systems quickly concentrate it in gutters and pipes. To counteract this, dual hydrologic goals are to slow and retain runoff (where possible), often through storage at one or more locations.

FLOW ATTENUATION

Onsite water retention with controlled, slow-release discharge reduces peak flow rates. Ponds are the most common example, but many SCMs such as bioretention areas, pervious pavements, infiltration cells, vegetated swales, and green roofs are effective.

VOLUME REDUCTION

The total volume of runoff from a site is reduced through retention, infiltration, and evapotranspiration. Water is retained in most SCMs, but the magnitude is highly influenced by the soil permeability. Uptake by plants in rain gardens and trees in street tree boxes contribute to volume reduction, as does evaporation from vegetation, the surface of wet ponds, and from puddles on impervious surfaces. Stormwater harvesting also has the potential to reduce runoff volumes, depending on the magnitude of storage and how quickly it is emptied between storm events.

Although physically changing the amount of stormwater may seem to be separate from water quality, reduction of the volume of stormwater has a direct, proportional reduction in the pollutant loads discharged to surface waters. In other words, a 50% reduction in runoff volume automatically reduces the pollutant load discharged from the site by half.

4.2.2. Physical treatment processes⁵⁴

Physical treatment refers to any type of process that uses some form of physics, i.e., physical barriers or forces to remove pollutants. In practical terms, these processes include every type of treatment other than removal through biological or chemical means. The most common methods are screening, filtering,

⁵³ Huber, W., Strecker, E., Heaney, J., & Weinstein, N. (2005). *Evaluation of best management practices and low impact development for highway runoff control: user's guide for BMP/LID selection*. Prepared for National Cooperative Highway Research Program, Transportation Research Board and National Research Council. Retrieved from <https://www.coralreef.gov/transportation/manual.pdf>

⁵⁴ Huber et al. (2005). *Evaluation of best management practices*.

and sedimentation, but flotation, flocculation, and clarification or many types of solid-liquid separating devices also are used.

Physical treatment processes are used in potable water and wastewater treatment plants. The same unit processes are used in stormwater treatment, but they are not usually recognized as such. When considering the most appropriate means of treating stormwater for a pollutant(s), it is helpful to choose an SCM that uses a unit process that effectively removes the pollutant(s) and to understand the mechanism at work.

The major physical unit processes employed by SCMs are:

SEPARATION BY PARTICLE SIZE

Differences in particle sizes are used to physically separate substances as they flow through a media or object with openings smaller than the larger substances, which are removed.

1. Screening – removes large items, such as trash and tree branches, with a screen or grate.
2. Filtration – removes small solids that fit into the pore spaces of the filter medium. Graded gravel beds, sand, or a specialized media mix are examples of filtration.

DENSITY SEPARATION

Density separation employs gravity to separate substances in water that have higher or lower densities than the water. Two different terms are used for the unit processes.

1. Sedimentation – separates particles with a density that is greater than water. Any device that slows the flow of stormwater will achieve gravity sedimentation, as heavier particles settle and collect at the bottom of a pond or swale, etc. Re-suspension of sediment is a common problem in swales, and designs must plan to minimize it for the SCM to maintain its intended function.
2. Flotation – removes substances with densities less than water (usually trash or oil) by skimming them off the surface of water in a hydrodynamic separator.

VOLATILIZATION

In volatilization, a phase change occurs as solids or liquids convert to a gaseous form and break away into the atmosphere. Pollutants that do this under normal ambient conditions are volatile or semi-volatile organic carbons (VOCs or SVOCs), petroleum aromatic hydrocarbons (PAHs), gasoline oxygenates (MTBE), and some herbicides and pesticides. These carbon compounds are commonly found in roadway runoff; some are known or suspected carcinogens and can contaminate groundwater easily, as they can remain dissolved in water through infiltration processes. Fortunately, many SCMs allow for volatilization to occur naturally. Shallow ponds with large surface areas and exposure to sunlight are good choices. If enough slope is present, agitation of shallow flows over an irregular surface promotes aeration and volatilization. Plants can also take in volatile compounds and release them through pores in their tissues.

AERATION

Aeration is a process of mixing air through water to increase the amount of dissolved oxygen (DO) in the water as free O₂ molecules. Rainwater will be saturated with oxygen from exposure to the atmosphere, but as microorganisms break down compounds picked up as stormwater flows across land or urban surfaces, oxygen is consumed and can become depleted. When this happens, anaerobic bacteria create the foul-smelling runoff that most urban inhabitants are familiar with. If receiving waters have low DO levels, deliberate aeration of runoff should be planned into the SCMs. As warmer waters cannot hold as much oxygen as cooler water, southern Florida starts at a disadvantage compared to cooler climates.

Increasing salinity also decreases the diffusion rate of oxygen into water. Passive aeration through turbulence is preferable to avoid the expense of energy to operate equipment, but in some cases electric aerators may be needed, such as submerged diffusers or jets. Fountains in the center of residential or commercial stormwater ponds provide an aesthetic benefit as well as needed stormwater aeration. Individual solar powered installments may be a suitable, relatively low-cost option to power stormwater aerators and minimize long-term operational expenses.

4.2.3. Natural disinfection

Disinfection refers to the destruction or inactivation of pathogens. In potable water and wastewater, chemical disinfection or concentrated ultraviolet light are the most common means of disinfection, but these are not practical in the much larger volumes and lesser concentration of contamination found in stormwater. Several options exist for natural disinfection:

1. **Exposure to sunlight:** Sunlight has wavelengths in the ultraviolet light range capable of killing pathogens. Warmer temperatures also aid disinfection. High turbidity or plant growth that limit the range of sunlight penetration will reduce sunlight's ability to disinfect stormwater. Therefore, shallow detention ponds with forebays to capture sediment are among the most effective SCMs.
2. **Sedimentation:** Individual bacteria and viruses typically sorb to sediment particles and will often settle from the water column.
3. **Soil filtration:** Bacteria are removed from water bodies by filtering through the soil profile. Sand filters and septic systems utilize this method.
4. **Inhibition of growth and predation:** Several natural factors slow the growth rate of bacteria and/or increase mortality such as low temperature, low nutrient levels, low moisture, and natural predators (e.g., consumption by larger microbes).⁵⁵
5. **Ultraviolet light:** High energy light disrupts the genetic material within micro-organisms, inactivating them and rendering them incapable of reproducing. This happens to some degree naturally in open water, and manufactured UV systems are used for disinfecting wastewater. This may be an option for potable reuse of harvested rainwater, but otherwise it is too costly to employ for stormwater.

4.2.4. Chemical Treatment Processes

SORPTION

Sorption is a chemical process in which one substance becomes attached to another; it is divided into adsorption or absorption, depending on the specific form of the attraction between the substances. Adsorption involves a physiochemical bonding—an ion exchange between molecules on the surfaces of the two substances. Absorption refers to an interaction between substances in two different states (a liquid and a gas or a solid and a liquid). One is physically taken in by the other.

Adsorption applies to most stormwater pollutants, including nutrients, metals, pesticides, and polycyclic aromatic hydrocarbons (PAHs). Petroleum hydrocarbons (oils and greases) are attached through

⁵⁵ City of Santa Barbara. (2002). *Stormwater treatment options stormwater treatment options for reducing bacteria in arroyo for reducing bacteria in arroyo burro and mission creek watersheds burro and mission creek watersheds* (Condensed Version) (p. 49). Creeks Restoration and Water Quality Improvement Division. Retrieved from <https://www.santabarbaraca.gov/civicax/filebank/blobdload.aspx?BlobID=16739>

absorption. The distinction may not be a factor in many SCMs, but it should be considered if filter media is an option for pollutant removal.

PRECIPITATION/COAGULATION/FLOCCULATION

These three processes are distinct but occur simultaneously, and as such they can be thought of as a single treatment process. Precipitation refers to the chemical process by which a dissolved pollutant comes out of solution, forming a solid particle. Flocculation is the attraction between particles causing them to combine into larger particles known as flocs. Coagulation is the process where a separate substance accelerates the flocculation rate. The floc (sludge) formed must then be removed by sedimentation or filtration.

Coagulation is common in potable water treatment, but, since it requires the addition of chemicals to catalyze the process, it is usually too expensive and labor intensive to be considered for the relatively low concentrations of phosphorous in stormwater. However, coagulation is effective for removing phosphorous, fine colloidal particles, and dissolved metals and has been employed to treat stormwater for reuse or other special cases.

CHEMICAL DISINFECTION

Chemical disinfection relies on a highly reactive compound, either a form of chlorine or ozone, to damage or kill pathogenic microorganisms and render them harmless. It also is not commonly used for stormwater disinfection, other than stormwater harvesting, because it requires active intervention and the ongoing expense of chemicals. Chemical disinfection can be done in a small space and is very effective, if stormwater is to be reused in residential irrigation applications. There may be other instances where disinfection is necessary and natural disinfection is not a viable option due to space requirements, and chemical disinfection may be preferred. If it is to be used, organic material should be minimized before the chemicals are added to reduce the amount needed and, if chlorine is used, to avoid creating chlorinated byproducts.⁵⁶

ELECTROCHEMICAL DISINFECTION

Electrochemical oxidation is a relatively new option for disinfecting stormwater for reuse. The process uses anodes made of either boron doped diamond or titanium dimensional stable anodes. It has previously been used for wastewater disinfection but is now being investigated for rainwater harvesting systems. The mechanism of disinfection with both anodes is chlorine, but it requires only a very low level of chlorine and uses very little energy input. Anode deterioration has been variable in tests to date, and more work is needed to optimize the process for stormwater.⁵⁷

4.2.5. Biological Treatment Processes⁵⁸

Living organisms, whether macro-scale plants or micro-scale algae and bacteria, need nutrients found in stormwater for growth and conveniently will take them in when in contact with the water. They may also take in or oxidize other chemicals and pollutants in the process.

⁵⁶ Huber et al. (2005). *Evaluation of best management practices*.

⁵⁷ Feng, W., McCarthy, D. T., Wang, Z., Zhang, X., & Deletic, A. (2018). Stormwater disinfection using electrochemical oxidation: A feasibility investigation. *Water Research*, 140, 301–310. <https://doi.org/10.1016/j.watres.2018.04.059>

⁵⁸ Huber et al. (2005). *Evaluation of best management practices*.

MICROBIAL MEDIATED TRANSFORMATIONS

Microbes (bacteria, algae, and fungi) live in stormwater, in soil, around plant roots, and on vegetation in contact with the water. In soil, most live near the surface, declining after a depth of about one foot. They use a variety of chemical reactions to transform organic pollutants and inorganic pollutants. Organic molecules may be metabolized for energy or use a process called mineralization to change the form of minerals bound in organic compounds to forms that are more available for use by plants and other microbes. Mineralization converts elements such as nitrogen, phosphorous and sulfur to support growth.

Microbes also transform inorganic pollutants as they oxidize or reduce metals during respiration (the process of obtaining energy from food sources). In stormwater, some microbes take in nitrogen in the form of ammonia (NH_4) and convert it to nitrate (NO_3), the form that is readily accessible to all plants and algae and the overabundant fuel driving eutrophication and algal blooms in surface and coastal waters.

Large surface areas and long residence times promote microbial transformations. Retention ponds, wetlands, and swales are SCMs that most effectively use these processes. However, when they are used, this first treatment step should be followed by a step that promotes denitrification to prevent excessive nitrates from moving downstream. Anaerobic or low oxygen conditions are essential to denitrification. Combinations of emergent and submerged wetland plants in surface aerobic zones and anoxic/anaerobic zones in deeper areas can provide nitrification and denitrification to remove dissolved nitrogen as well as phosphorus from stormwater.

UPTAKE AND STORAGE

Plants, algae, and other microbes take in essential nutrients (nitrogen and phosphorous) to support their growth. In the process, other pollutants are taken in and may bio-accumulate as they are stored in their tissues. These compounds include petroleum hydrocarbons, herbicides, pesticides and chlorinated solvents.

The relative amount of nutrients and associated compounds taken in by plants is dependent on soil conditions, evapotranspiration rates, and individual plant physiology. If an SCM is being designed to remove a specific pollutant, research into the most appropriate plant species may be helpful.

The ability of plants and other organisms to take in metals depends on a factor termed bioavailability, which is broadly broken into three categories. Readily bioavailable metals are cadmium, nickel, zinc, arsenic, selenium, and copper. Iron, manganese, and cobalt are considered moderately bioavailable, and lead, chromium, and uranium are not easily bioavailable. Some plants, called hyper-accumulating, can take in 100 times as much metal as most other plants.⁵⁹ Therefore, choosing the best plants for a known metal contaminant is very important if that contaminant is to be removed effectively.

A summary of the various treatment processes and the SCMs that employ them can help guide the selection process (Table 4-1).

⁵⁹ Huber et al. (2005). *Evaluation of best management practices*.

Table 4-1. Water treatment processes associated with BMP options, pollutants removed, and description.

Treatment Process	BMP Options	What is Removed?	How Does It Happen?
Flotation	Skimmers Oil/water separators Density separators	Oil and other hydrocarbons Trash	Substances lighter than water are removed with units specifically designed for this purpose.
Settling / sedimentation	Bioretention wetlands Wet or dry ponds Tree boxes Cisterns	Suspended solids Metals Particulate phosphorus Organics	Suspended particles settle by gravity, along with pollutants adhered to them. Forebays must capture and facilitate periodic removal of sediment. Avoid re-suspension of sediment.
Filtration	Sand / gravel filters Natural / amended soil Green roofs Infiltration tanks Horizontal wells	Suspended solids Metals Phosphorus Organics	Stormwater passes through a porous material, mechanically removing anything larger than the pore openings.
Sorption (adsorption / absorption / ion exchange)	Any BMP employing infiltration thru soils or other media, especially organic material or clay.	Dissolved nutrients Metals Bacteria	Contaminants adhere to irregularities in the surface of vegetation, to clay particles in soil, or are attached to other molecules by chemical bonds
Biological removal	Bioretention Enhanced ponds Floating islands	Nitrogen Phosphorus Organic molecules	Microorganisms and plants take in nutrients needed for their cell growth and break apart large organic molecules.

4.3. Treatment Train Approach

LID techniques for stormwater management are small and distributed throughout a catchment area. Any one technique generally does not function to control or treat all runoff by itself. Therefore, designs should use several LID techniques (e.g., bioretention basins and swales) in a development to create a stormwater treatment train. LID projects should have a minimum of two LID structural features in a treatment train series, as well as upstream source control measures. Selecting the most appropriate techniques depends on the volume of runoff that must be treated, the expected pollutant load, soil permeability, the wet-season depth to groundwater, as well as the lifetime costs (Table 4-2).

4.3.1. Source controls (stormwater control methods)

Source controls are simply protective and preventative methods, also termed “” control methods. They minimize the area disturbed, changes to the natural hydrology and the amount of impervious areas.

These steps reduce the amounts of nutrients and other pollutants that enter stormwater runoff. Source controls must be considered at the very earliest stages of design, as they effect the basic layout of a new development. Other source controls employed during the design phase include clustering development, retaining natural areas on a site, the use of Florida-Friendly Landscaping™ to reduce the need for fertilizers, and avoiding soil compaction on pervious areas. During normal operation (post-construction), source controls focus on limiting pollutants entering the environment.

Impacts to the natural hydrology and water quality that remain after source controls are implemented must be managed through other SCMs.

4.3.2. Development/neighborhood/street-scale controls (structural stormwater control methods)

Street- or community-scale controls serve to slow, retain, and treat stormwater, similar to non-structural methods. In addition, they connect individual sites together and may detain and transport stormwater, provide retention, or water quality treatment on a larger scale. Common examples include vegetated swales, parking lot islands, tree boxes or other forms of bioretention, pervious pavement on streets, and enhanced stormwater ponds. These are generally owned and maintained by homeowner’s associations, property managers or management companies, or local government.

Street- or neighborhood-scale projects may combine elements of shared community green spaces, traffic calming, and increased walkability with stormwater management to promote social cohesion and residents’ health, particularly in town centers and mixed use neighborhoods.⁶⁰ The second phase of Miami’s Wagner Creek Restoration project is one example: it proposes GI to manage and treat stormwater in conjunction with providing parks and urban beautification to improve community wellbeing.⁶¹

⁶⁰ Jehollow. (2018, November 7). *San Francisco, California: public utilities commission green infrastructure projects*. Retrieved from <https://sustainability.asu.edu/urbanresilience/2018/11/07/san-francisco-california-public-utilities-commission-green-infrastructure-projects/>

⁶¹ Jehollow. (2018, November 13). *Miami, Florida: Wagner Creek restoration*. Retrieved from <https://sustainability.asu.edu/urbanresilience/tag/community-wellbeing-and-quality-of-life/>

Table 4-2. Functional aspects of LID techniques.

Stormwater Control Measure	Infiltration	Runoff Minimization	Runoff Reuse	Water Quality Improvement	Reduced Maintenance & Water Usage	Construction Timing
Amending disturbed or compacted soil	Dark Grey	Light Blue	Light Blue	Light Blue	Light Blue	Late
Permeable pavement (often with storage under pavement), mulch, gravel	Dark Grey	White	White	White	White	Middle
Grassy or vegetated swales on uncompacted soil (includes curb cuts)	Dark Grey	Light Blue	Light Blue	Light Blue	Light Blue	Early to middle
Dry wells or exfiltration tanks	Dark Grey	White	White	White	White	Middle
Bioretention (rain garden)	Dark Grey	Light Blue	Light Blue	Dark Grey	Light Blue	Middle to late
Tree boxes and tree filters	Dark Grey	White	White	Dark Grey	White	Middle to late
Vegetated Natural Buffers (VNB)	Dark Grey	Light Blue	Light Blue	Dark Grey	Light Blue	Early
Tree canopy retention and drip line root protection	White	Dark Grey	White	White	White	Very early
Neighborhood design	Light Blue	Dark Grey	Light Blue	Light Blue	Light Blue	Very early
Reducing Directly Connected Impervious Areas (DCIA)	White	Dark Grey	White	White	White	Early
Green roofs (vegetated roofs)	Light Blue	Dark Grey	Light Blue	Dark Grey	Light Blue	Middle
Minimization of site disturbance and/or construction footprint	White	Dark Grey	White	Dark Grey	White	Early
Cisterns and rain barrels	Light Blue	Light Blue	Dark Grey	Light Blue	Light Blue	Middle to late
Stormwater reuse ponds	White	White	Dark Grey	White	White	Middle to late
Florida-Friendly native landscaping	Light Blue	Light Blue	Light Blue	Light Blue	Dark Grey	Late
Drip irrigation	White	White	White	White	Dark Grey	Late

4.3.3. Site controls (structural SCMs)

Site-level controls are generally measures to slow, retain, and treat stormwater on a building or lot scale. They can be termed “structural” stormwater control measures, although some require only minimal modification to design or construction plans, such as disconnecting impervious areas (primarily discharging roof downspouts to vegetated areas) or converting parking lot islands to bio-retention measures by adding curb cuts and lowering their grade level. Measures such as rain gardens, use of pervious pavement for driveways, and green roofs are also site controls.

Site-level controls are typically owned and maintained by the individual property owners, although some communities take over maintenance on private property. When local governments lack ultimate control over maintenance, there may be a reluctance to credit volume reduction or treatment benefits. However, there are documented examples of communities making site controls work well, and as they become more common, they may be easier to install and credit in the regulatory process. Long-term maintenance must be planned and carried out for all SCMs to ensure their effectiveness.

4.3.4. Online vs. offline treatment

Most treatment train SCMs are organized sequentially, where all runoff flows through the system in a straight line, with excess volume from one SCM flowing through an overflow outlet or spillway. This is what is meant by online treatment. Runoff from a site might flow into a vegetated swale, then into a treatment pond with an overflow that discharges to a receiving stream or canal. All of the upstream flow enters each SCM sequentially, and all excess volume overflows downstream.

In contrast, offline treatment has a side branch where the first quantity of runoff (equal to the needed treatment volume) is captured, held, and infiltrated or otherwise discharged. Excess runoff above the treatment volume bypasses the side branch and continues downstream into other SCMs or a receiving water as before. This configuration fully retains the first flush of runoff without mixing it with any following runoff. As the first-flush generally carries higher concentrations of pollutants, setting it aside for infiltration or treatment keeps a greater proportion of pollutants from flowing into receiving water bodies. This type of design requires a diversion box to direct the flow, first into the treatment pond and then overflow into the primary flow path. Figure 4-5 shows a schematic diagram of an offline treatment system.⁶² Although this diagram has a second pond that fills after the treatment pond, the same principle can be used with a single pond in situations where greater detention for flood control is not needed.

Required treatment volumes are generally a half inch of runoff from the contributing area if retention is provided offline, but double (one inch) if treatment is provided online.⁶³ Other design criteria are discussed in Section 5-2.

⁶² Livingston, E. H., & McCarron, E. (n.d.). *Stormwater management: a guide for Floridians*. Florida Department of Environmental Regulation. Retrieved from http://www.pinellas.wateratlas.usf.edu/upload/documents/Stormwater_Guide_for_Floridians.pdf

⁶³ Escambia County. (2016). *Escambia County LID manual*.

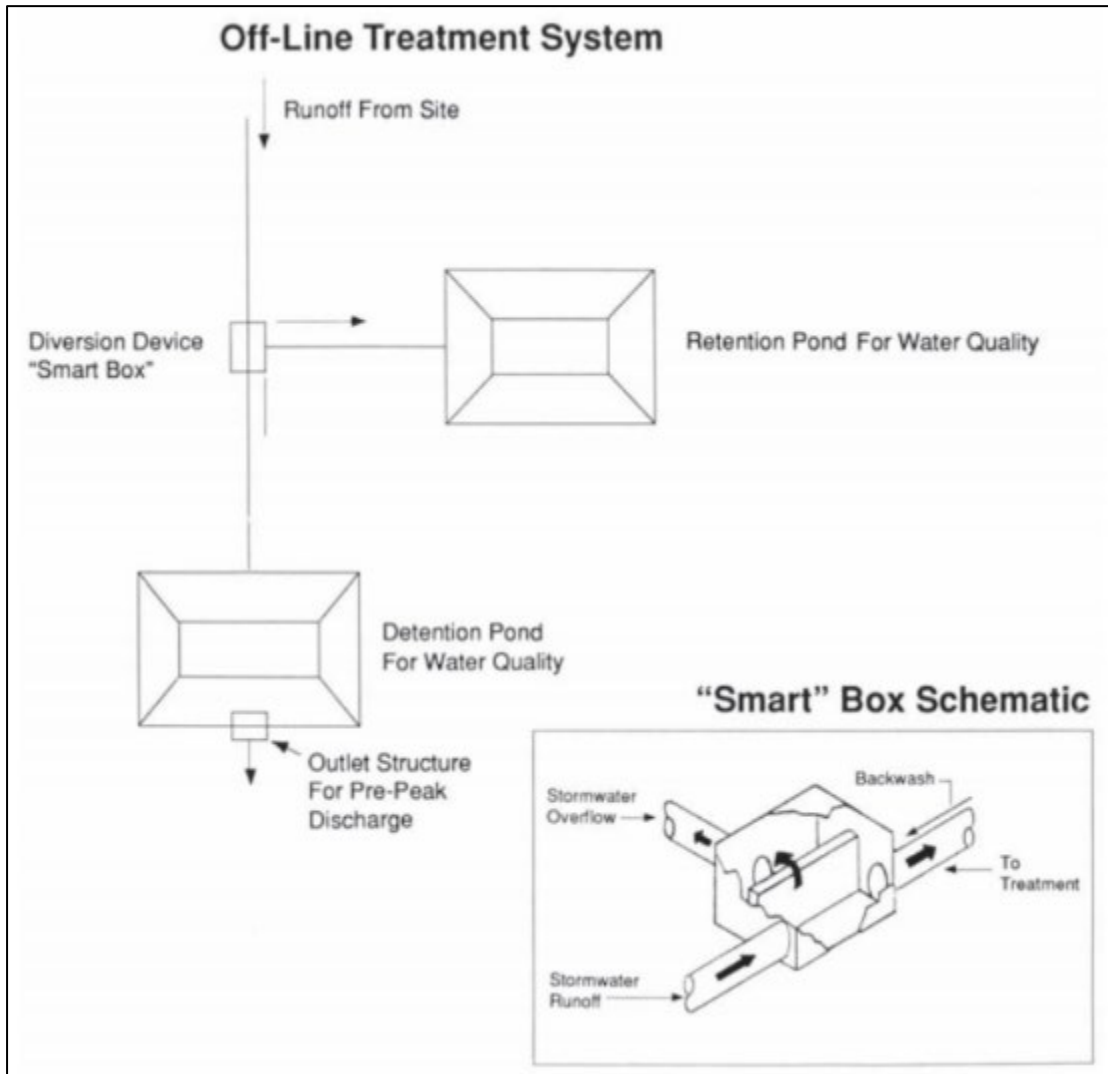

Figure 4-5. Schematic of "dual-pond" offline treatment system.

5. LOW IMPACT DEVELOPMENT STORMWATER CONTROL MEASURES

Once a comprehensive plan for integration of LID/GI SCMs has been developed, ideally configured as a treatment train, the next step is to understand the range of SCMs available for application, their primary treatment and/or volume control mechanisms, and the site-specific criteria and conditions within which optimal performance can be achieved. This chapter begins with a broad introduction to SCMs within the context of this manual (Section 5.1), a description of the most common categories of non-structural SCMs and, a discussion of the attributes that distinguish them from structural SCMs (Section 5.2), and a listing of key design criteria applicable to structural SCMs (Chapter 5.3). Each subsequent section (5.4 through 5.23) provides detailed information for a specific SCMs or subcategories of SCMs that share common functions or features. Each subchapter provides insight to the following questions:

1. *What are the key elements or components of the stormwater control measures (SCMs)?*
2. *Why should a particular SCM be considered? What are the potential benefits associated with it?*
3. *Where/under what conditions is the SCM most applicable/potentially beneficial to meeting a project's source control, water quality, and/or stormwater management goals?*
4. *What unit processes does the SCM use or apply to assimilate or remove pollutants of concern?*
5. *Are there design criteria unique to the SCM that must be adhered to and/or are broadly applicable across a range of Southeast Florida conditions, sites, and management applications?*
6. *What is the modeled performance or expected pollutant removal capacity of the SCM?*
7. *Are there examples of the SCM being used in Southeast Florida both successfully and with limited success?*
8. *Are there new trends or recently established standards for the SCM?*

Specific LID SCMs discussed in Sections 5.4-5.23:

- Soil Amendments
- Green Roofs
- Cisterns & Rainwater Harvesting
- Underground Storage & Exfiltration
- Permeable Pavement
- Infiltration/Exfiltration Trenches & Dry Wells
- Bioretention Cells
- Buffer Strips
- Infiltration Planters & Tree Box Filters
- Vegetated Swales
- Flow Control Devices
- In-stream Bioreactors
- Filter Systems
- Basin Inserts
- Nutrient Separating Baffle Boxes
- Infiltration Basins
- Enhanced Stormwater Ponds
- Floating Wetlands
- Onsite Wastewater Treatment Options
- Living Shorelines

5.1. Introduction

This list of SCMs consistent with LID covers those most applicable to Southeast Florida, although not all will be appropriate for all locations.

5.2. Non-structural Low Impact Development Stormwater Control Measures

Most non-structural LID techniques must be considered early in the conceptual design of a project, and several have been discussed in Section 4.1.1 as part of the initial planning process. Other measures primarily related to lot designs are described in this section.

The SFWMD credits source controls as protective measures as part of an Environmental Resource Permit (ERP) application for discharges to an OFW or an impaired water body. Appendix E of their ERP Applicant's Handbook, Volume II lists source controls as "reduced turf coverage; native landscape plantings; stormwater harvesting and recycling; rooftop runoff management and recycling; pervious pavement; and vegetated non-turf buffers around detention/retention ponds,"⁶⁴ but other measures will also be considered. Specific stormwater pollutant load reduction credits are not quantified for non-structural measures, but may be estimated when calculating pre- and post-development stormwater volume, especially if the calculations are based on the percent directly connected impervious area (DCIA) and the non-DCIA curve number (CN), as in the [Harper methodology](#).

5.2.1. Reduce impervious areas

DESCRIPTION AND APPLICABILITY

Two types of strategies are available for reducing impervious areas. The first is just to make impervious areas smaller. This includes cluster design, building vertically (obtaining floor space with multiple stories to reduce a building's footprint), minimizing road pavement lengths and widths, and shortening driveway lengths (covered in Section 4.1.1). Parking lots may also be larger than required and could be decreased in size.

The second type of strategy to reduce impervious cover is to replace portions of the needed hardscape with pervious materials. Pervious concrete, asphalt, permeable pavers, or reinforced turf systems are options for many urban locations, such as pedestrian areas, residential driveways, and on-street parking lanes or parking lots. Green roofs are another example of replacing impervious with pervious material. These are covered individually as structural SCMs.

BENEFITS

By just minimizing the amount of impervious cover on a site, lower volumes of stormwater runoff are generated. This allows smaller structures to be used for further stormwater management and saves space as well as construction and maintenance costs. Replacing some impervious surfaces with pervious SCMs reduces both runoff volumes and pollutant loads to the degree provided by the alternative SCM. Urban heat island effects are reduced by additional green spaces, reducing the energy needed for cooling buildings and increasing human comfort.

EFFECTIVENESS

The reduced volume of stormwater will be proportional to the amount of impervious area reduced or replaced and the infiltration capacity of the soil. Nutrient and other pollutant concentrations in stormwater runoff can be expected from increased pervious areas, whether from infiltration in undisturbed land or as calculated based on the type of SCM employed as a replacement.

⁶⁴ South Florida Water Management District. (2016). *Environmental resource permit applicant's handbook*.

5.2.2. Disconnected impervious areas

DESCRIPTION AND APPLICABILITY

When impervious areas such as roofs, parking lots, and pedestrian areas drain stormwater directly into inlets and storm sewers, runoff is removed from the site and quickly concentrated at some receiving point downstream. Almost all rainfall becomes runoff (no infiltration or transpiration occurs, and there is minimal surface evaporation). Peak flow rates are much higher than in undeveloped conditions. By simply inserting a vegetated area or storage SCM between large impervious surfaces and a piped stormwater collection system, peak flow rates and runoff volumes can be decreased close to their source. Other techniques to disconnect impervious areas include the elimination of curb and gutters, where runoff from roads, sidewalks, and driveways is directed into vegetated swales. The use of curb cuts to direct flow from parking lots into vegetated islands is another example.

These techniques are applicable in most suburban and many urban developments. Parking lot disconnections and divided highway median strips are reasonable options for redevelopment projects. In many low- to medium-density residential areas, private property owners can easily redirect roof runoff from downspouts onto landscaped areas or lawns. Constructing raingardens or exfiltration trenches to treat a greater volume of stormwater may be feasible for multifamily, commercial, or public buildings. Municipalities may offer reduced stormwater fees for private landowners that participate in programs to disconnect impervious areas by redirecting flow from paved surfaces.

BENEFITS

Disconnecting impervious areas allows the runoff response to be attenuated with delayed and reduced peak flows and usually a reduction in runoff volumes. If the practice is used consistently, the size of downstream stormwater infrastructure may be reduced. Slower runoff velocities also decrease erosion.

5.2.3. Curb elimination and curb cuts

DESCRIPTION AND APPLICABILITY

Some local ordinances require curbs and gutters in most residential areas, and they are often desired to maintain proper traffic patterns in commercial and other public areas. Tire stops can also serve this purpose. Where curbs are going to be used, the elimination of stormwater inlets and piped conveyances can still be considered if runoff is directed to pervious areas through curb cuts. Whether gutters are required depends on how stormwater is being treated and managed downstream. Periodic inspections are required to check that runoff is flowing as intended; that curb cuts are not blocked by sediment, vegetation, or debris; and that the downstream, vegetated area is not eroded.

DESIGN CRITERIA

Factors to consider when designing the number, placement, and design of curb cuts include:

- Openings of at least 18 inches wide are recommended to reduce the potential for clogging.
- The sides of the cuts can be vertical or at 45-degree angles.
- The bottom of the curb cut must slope away from the pavement.
- A 2-inch drop is recommended between the pavement and the vegetated area.
- Consider whether a concrete pad or gravel area is needed to dissipate energy and prevent erosion at entry points to rain gardens or parking lot islands.

5.2.4. Fertilizer reduction strategies

DESCRIPTION AND APPLICABILITY

Excessive use of fertilizers on urban landscapes is a contributing source of nutrient pollution to Florida surface water and groundwater. Excess nitrogen and phosphorus from fertilizers that are not taken up by plants are often washed away by stormwater or move into the groundwater. The FDEP developed a model ordinance to require Florida-Friendly fertilizer use on urban landscapes. Florida Statute 403.9337 requires local communities that contain watersheds of waterbodies impaired for nutrients to adopt it as a minimum. Other communities interested in limiting nitrogen to surface water and groundwater are encouraged to adopt similar ordinances.⁶⁵ The FDEP also promotes the use of Florida-Friendly landscaping and fertilizers through the BMAP process, which allows for load reduction credits for total nitrogen and phosphorus in calculating BMAP loads if local governments have ordinances requiring their use.⁶⁶

Landscape ordinances may reduce the amount of turf in residential landscapes. Shrubs and landscaped beds require much less fertilizer than turf; therefore, simply reducing the percentage of turf can have a significant effect on the amounts of fertilizer applied in new residential areas. Programs that subsidize the cost of homeowners replacing a portion of their existing turf with alternative landscapes have also been used in Florida. Irrigation ordinances may also reduce nutrient loads if they result in fewer homes overwatering, leaching nutrients, and washing excess fertilizers into the stormwater system.

Public education is a third strategy that local governments can employ to reduce nitrogen loads. The Florida Yards and Neighborhood (FYN) program is one example of such public education. In addition to educating participants on appropriate fertilizer usage, the FYN program has components about Florida-Friendly landscaping, efficient irrigation, managing yard waste, reducing stormwater runoff, and protecting waterfronts (including wetlands ponds and canals).⁶⁷

⁶⁵ Florida Legislature. (2018). *Section 403.9337. Model ordinance for Florida-friendly fertilizer use on urban landscapes*. Retrieved from http://www.leg.state.fl.us/statutes/index.cfm?App_mode=Display_Statute&Search_String=&URL=0400-0499/0403/Sections/0403.9337.html

⁶⁶ Florida Department of Environmental Protection. (2018). *Statewide best management practice (BMP) efficiencies for nonpoint source management of surface waters - draft*. Florida Department of Environmental Protection. Retrieved from <https://floridadep.gov/sites/default/files/BMP%20Efficiencies%20July%202018.pdf>

⁶⁷ University of Florida/IFAS Extension Service, Florida Department of Environmental Protection. (2015). *The Florida*

BENEFITS

Reduced nitrogen concentrations in stormwater runoff can be expected from these strategies, although the effects are difficult to quantify.

UNIT PROCESSES

Reducing fertilizer application is a source control that prevents excess nutrients from entering the environment rather than treating pollution.

EFFECTIVENESS

The effectiveness of fertilizer reduction strategies will vary depending on the communities' initial usage and compliance with reduction requirements. Areas with large numbers of homes using commercial landscape maintenance may see the greatest benefit. However, as an estimate of effectiveness fertilizer reduction strategies, in a 2018 BMAP, the FDEP allowed a credit of 0.5% decrease in nitrogen loads to groundwater each for fertilizer, landscape, and irrigation ordinances. Participation in the Florida Yards and Neighborhoods (FYN) program was allowed a 3% credit, and other public education programs were each allowed a 1% credit.⁶⁸

DESIGN CRITERIA

Fertilizers applied to golf courses are another source of nitrogen in stormwater. The FDEP estimates that, on average, golf courses apply 3.24 lbs. of nitrogen per 1,000 square feet of turf annually. In the absence of more specific measurements of initial use, this rate may be useful for estimating load reductions.

EXAMPLES

Fertilizer ordinance: Martin County has adopted a fertilizer ordinance that has been widely used as a model by other communities bordering the Indian River Lagoon.⁶⁹ Some of its requirements are:

- No phosphorus content is allowed in fertilizers (the middle number on a bag must be 0), unless a soil test has indicated a phosphorous deficiency.
- The nitrogen in fertilizers must be at least 50% slow release.
- During the summer months, June 1 through September 30, use of fertilizers containing nitrogen or phosphorus is not allowed.
- The public should not fertilize when rain is forecasted to prevent fertilizer washing away into the groundwater and waterways.
- A 25-foot, fertilizer-free buffer is required around all water bodies.
- Deflector shields should be used to keep fertilizer granules away from all impervious surfaces, fertilizer-free zones, no-mow zones, and water bodies.

Yards & Neighborhoods Handbook. University of Florida. Retrieved from https://ffl.ifas.ufl.edu/materials/FYN_Handbook_2015_web.pdf

⁶⁸ Division of Environmental Assessment and Restoration Water Quality Restoration Program. (2018). *Santa Fe River Basin Management Action Plan* (p. 96). Florida Department of Environmental Protection. Retrieved from <file:///C:/Users/ljarrett/Documents/LID%20SE-FL/Santa%20Fe%20Final%202018.pdf>

⁶⁹ Martin County, Florida. (2019). *Fertilizer ordinance information*. Retrieved from <https://www.martin.fl.us/Fertilizer>

- Grass clippings and vegetative material must be kept away from streets, storm drains, and water bodies.

Public education: The Coral Reef Conservation Program publishes a brochure to educate the public on the effects of fertilizers and pesticides on coastal waters and coral reefs.⁷⁰

5.2.5. Street sweeping

DESCRIPTION AND APPLICABILITY

Street sweeping is done periodically on urban streets for aesthetic reasons—to remove visible trash and debris—as well as for stormwater pollutant minimization. Sediment, leaves, rocks, and small amounts of solid wastes are typically collected during routine street cleaning and maintenance. On-street parking will greatly reduce the benefit of sweeping, as the majority of sediment and debris collects along curbs.

The most common type of sweeping truck is a mechanical broom sweeper. Older models are effective for removing larger solids, but they leave behind fine particles and have limited benefits for nutrient reduction. Newer technology encloses the brooms and collects material with a filtered vacuum fan. Regenerative air sweepers and vacuum-assisted sweepers use suction to pick up solids and are likely to be more effective for minimizing nutrients in stormwater. Water is generally sprayed to control dust generated by the sweeping.

The material collected from sweeping may be combined with sediment collected in stormwater catch basins and/or treatment ponds for disposal or beneficial use. They typically contain small amounts of metals that can leach into soil and groundwater (Table 5-1).⁷¹ They can be disposed of in Class I or II landfills or waste-to-energy facilities, or, when there is low concern of contamination, in a Class III landfill, but not with construction and demolition debris.

BENEFITS

Solids from roadways are collected near their source, removing them before they enter water bodies. Street sweeping solids contain metals such as arsenic, barium, copper, chromium, lead, aluminum, and iron along with nutrients, petroleum, and organic pollutants. These loads are reduced in proportion to the amount of solids collected.

UNIT PROCESSES

Street sweeping is a source control that physically removes pollutants associated with sediment and other solid materials.

EFFECTIVENESS

The type of equipment used for street sweeping may have a major impact on their effectiveness for sediment and nutrient removal. In the Chesapeake Bay area, weekly cleaning with mechanical broom

⁷⁰ Florida Department of Environmental Protection. (n.d.). Protect Florida's coral reefs [Brochure]. Retrieved from https://floridadep.gov/sites/default/files/LBSP_24_Fertilizer.pdf

⁷¹ Department of Environmental Protection Solid Waste Section. (2004). *Guidance for the management of street sweepings, catch basin sediments and stormwater system sediments* (p. 19). Retrieved from https://floridadep.gov/sites/default/files/GuidanceSt-Sweep_05-03-04_0.pdf

sweepers was found to remove, at best, about 1% of sediment, while trucks employing suction cleaning methods removed about 16% of sediment.⁷²

Florida-specific research on nutrient loads from solids looked at material collected during street sweeping and solids removed from catch basins and other stormwater SCMs designed to trap sediment (such as hydrodynamic separators). The study found that N and P loads removed could be predicted from measuring dry particulate matter, given the source of recovered solids, i.e., street sweeping, catch basins, or sedimentation basin, from any type of SCM and the general category of land use, namely commercial, residential, or highway. The median cost to remove TN and TP through street sweeping was found to be considerably less on a per pound basis, than the cost of removing nutrients in sediment collected in either catch basins or in an SCM treatment train (Table 5-1).⁷³

Table 5-1. Median TP and TN loads and unit removal costs measured in recovered sediment from 14 Florida locations.

TP (mg/kg)	Street Sweeping	Catch Basin	Any SCM
Commercial	381	301	296
Residential	375	423	383
Highway	350	537	514
Median Cost (\$/lb. P)	\$257	\$1,656	\$32,600

TN (mg/kg)	Street Sweeping	Catch Basin	Any SCM
Commercial	430	467	602
Residential	832	773	1169
Highway	546	785	939
Median Cost (\$/lb. N)	\$165	\$1,016	\$935

DESIGN CRITERIA

The frequency will vary by location and season of the year. During wet summer months, there may be little time for solids to accumulate on roadways. At these times, efforts may be better focused on removing sediment from structural SCMs. Central city streets and streets near waterbodies are likely to

⁷² Chesapeake Bay Program. (2018, August 10). *BMP reference sheet d-9: street cleaning (street sweeping)*. Retrieved from https://www.chesapeakebay.net/documents/BMP-Guide_D.9_Street-Cleaning-Street-Sweeping_.pdf

⁷³ Sansalone, J. J., Berretta, C., Raje, S. (2011). *Quantifying nutrient loads associated with urban particulate matter (PM), and biogenic/litter recovery through current MS4 source control and maintenance practices* (p. 77). Florida Stormwater Association Educational Foundation (FSAEF). Retrieved from <https://www.florida-stormwater.org/assets/FSAEF/Research/MS4/ms4%20assessment%20project%2011%20final%20report.pdf>

need sweeping most frequently—up to twice weekly—followed by commercial and industrial areas. Residential streets may only be swept a few times per year. Infrequent sweeping will reduce the water quality benefits.⁷⁴

5.3. General Structural Stormwater Control Method Design Criteria

5.3.1. Crediting pollutant load reductions

Required retention and detention treatment volumes will dictate the design volume and credit accorded to SCMs that employ these techniques. For other SCMs, specific stormwater pollutant load reduction credits are not quantified by SFWMD, but designs are credited on a case-by-case basis when supporting documentation of reasonable treatment efficiencies is provided by the applicant.

For an ERP application discharging to an OFW or an impaired water body, the SFWMD credits three types of strategies involving structural SCMs as protective measures (Appendix E, ERP Applicant’s Handbook, Volume II), including:

- An increased hydraulic residence time – to a minimum of 21 days;
- Conveyance and pretreatment BMPs – filter strips, vegetated swales and inlets, baffle boxes and other structures that trap sediment, and pretreatment with dry retention or detention; and
- Water quality treatment enhancement – specifically constructed wetlands used as a polishing cell after primary treatment or upstream of an outfall structure; littoral berms, settling basins, or phyto-zones (vegetation removes nutrients) within a wet detention pond; or increased effective treatment time within a detention pond achieved through an increased flow path created with internal berms and/or changed locations of inflow and outflow structures.



Figure 5-1. Stormwater ponds with and without littoral zone plantings. (Photos: UF PREC)

- This is not an exclusionary list; other protective measures are considered by the SFWMD, if documentation is provided to “demonstrate reasonable assurance that water quality standards will not be violated during construction and during long term operation.” Two measures that are excluded from consideration are harvesting algae from wet ponds and using natural wetlands for stormwater treatment. Treatment trains may be permitted, assuming the overall treatment

⁷⁴ Wanielista, & Livingston. (2016, September). *Escambia County LID BMP Manual*.

efficiency is calculated correctly, recognizing the load reductions that occur in upstream treatment at the influent of subsequent SCMs.⁷⁵

- Although SFWMD does not suggest specific methodologies for calculating pollutant removals by SCMs, the FDEP does provide some guidance for calculating Total Phosphorous (TP) and Total Nitrogen (TN) treatment efficiency for BMAPs. Note, the water management districts approve ERPs for most urban developments, but these methodologies may be suitable for other ERPs, as well. Their guidance is provided in the FDEP's July 2018 draft document, [Statewide Best Management Practice \(BMP\) Efficiencies for Nonpoint Source Management of Surface Waters](#), with tables of suggested percentage nutrient/pollutant removals, equations or other methodologies to calculate removals for many LID SCMs. It is a working document that the FDEP intends to update as needed when new information is available. However, these are not guaranteed credits, as the SFWMD must review the specifics and approve each application on a case-by-case basis.

Some common design criteria for various structural stormwater SCMs are listed below. Additional requirements or modifications to these criteria are noted with the discussion of each SCM. These lists are not intended to cover all necessary design considerations, but rather they highlight some key areas, especially those that may affect the siting or choice of the most appropriate SCM. Local government regulations must be consulted in addition to the full SFWMD requirements.

5.3.2. Required treatment volume and recovery⁷⁶

For all SCMs, treatment volumes must meet the minimum treatment required by the SFWMD, or the local government requirements if they are more stringent. The SFWMD sets the following minimum treatment volumes for stormwater systems (Section 4.2.1 of the [ERP Applicant's Handbook Volume II](#)), for a single SCM or multiple SCMs if a treatment train is used:

- **Wet detention** - Must provide a volume equivalent to the first inch of runoff from the total developed area, or 2.5 inches of runoff from the impervious area, whichever is greater
- **Dry retention** - At least 75% of the volume that would be required for wet detention must be provided.
- **Retention** – Treatment volumes must be at least 50% of the calculated wet detention volume. Evidence of long-term ability to sustain infiltration and an operations and maintenance guarantee is required.
- **Outstanding Florida waters (OFW)** – If direct discharge is made to an OFW, an extra 50% treatment volume is required.
- **Pretreatment** – At least an additional 0.5 inch of pretreatment, in either dry detention or retention, is required for:
 - all commercial or industrial projects; and

⁷⁵ South Florida Water Management District. (2016). *Environmental resource permit applicant's handbook*.

⁷⁶ South Florida Water Management District. (2016). *Environmental resource permit applicant's handbook*.

- projects with >40% impervious area that discharge directly into OFW, Class I, or Class II waters, or to other specified receiving waters ([Section 4.2.2\(b\)](#)).
- **Retrofits** – The required water treatment volume of existing stormwater ponds are evaluated on a case-by-case basis, but as a general practice, they must provide extra water quality treatment.
- **Credit for inlets in grassed areas** – Systems can receive up to 0.2 inches of the wet detention treatment volume based on the ratio of impervious to pervious areas. A 10:1 ratio earns full credit, reduced proportionally for higher impervious areas.
- **Minimum drainage rate** – Residential projects must be able to discharge to surface water or through infiltration at least 3/8 inch per day, and the full stored volume is discharged within 12 days. Commercial and industrial projects must comply with Section 3.9 (b).
- **Recovery of treatment volume** – For gravity controlled discharges, the maximum design discharge is ½ inch of the required treatment volume in 24 hours. This remains the same whether discharge is to surface waters for detention SCMs or through soil infiltration for retention SCMs.
- **Detention bleed-down mechanisms** – Gravity discharges can be made through V notch weirs with a maximum angle of 20 degrees or through openings with a cross section area of at least 6 inches and a minimum dimension of 2 inches. Pumped discharge is to be 20% of the detention volume per day.
- **Mounding analysis** - A recovery analysis that accounts for the mounding of groundwater beneath retention SCMs is required. More information about mounding analysis and supporting soil testing are provided in the [SFWMD Environmental Resource Permit Applicants Handbook](#).

5.3.3. Rainfall and abstractions⁷⁷

DESIGN STORM

The design storm for offsite discharges should be assumed to be a 25-year return frequency, 3-day rainfall event unless the water management district or local governments require more stringent criteria. Flood protection for roads and parking lots use a 5-year, 1-day design storm, unless an exfiltration system is used where a 5-year, 1-hour storm is specified.

EVAPOTRANSPIRATION DESIGN RATES

The SFWMD allows the following evapotranspiration rates to be estimated from soils based on the depth to groundwater table.

⁷⁷ South Florida Water Management District. (2016). *Environmental resource permit applicant's handbook*.

Table 5-2. Estimated evapotranspiration rate, relative to groundwater depth.

Groundwater depth (ft)	Evapotranspiration rate (in/day)
0 – 1'	0.3
1' – 2.5'	0.2
2.5' – 4'	0.1
>4'	0

5.3.4. Soil characteristics

INFILTRATION RATES

For retention SCMs, the minimum infiltration rate through vegetation and soil must be at least one inch per hour or two inches per hour for soil underlying pervious pavement systems.

DEPTH TO GROUNDWATER

The seasonal high groundwater table must be at least two feet beneath the bottom of all retention SCMs unless the applicant demonstrates, based on plans, test results, calculations, or other information, that an alternative design is appropriate for the specific site conditions.

SOIL STORAGE CAPACITY

The maximum amount of water storage available in soil above the water table can be estimated from the following table.⁷⁸

Table 5-3. Water storage available in soil above the water table.

Depth to water table (ft)	Cumulative water storage (in)
1'	0.6
2'	2.5
3'	6.6
4'	10.9

5.3.5. Other requirements

PRE VS. POST FLOWS

Post-development peak flow rates generally should not exceed pre-development rates for greenfield sites. In cases of redesign, the pre-development rate may not be applicable, and the standard may

⁷⁸ South Florida Water Management District. (2016). *Environmental resource permit applicant's handbook*.

require that existing conditions be maintained or improved. Calculations may include storage provided by any SCM present, including depression storage.

TAILWATER ELEVATIONS

Tailwater elevations need to be considered in stormwater management systems design so that receiving waters do not limit effective flow or storage within the SCM. Peak stages under the project design storm must be used, unless it can be shown that SCM flows would arrive prior to maximum stages in the receiving water.⁷⁹

ELEVATION OF NEARBY ROADWAYS

The control elevation of an SCM near a roadway should be at least two feet lower than the minimum crown elevation of a nearby roadway.

DISTANCES TO POTABLE OR WASTEWATER SYSTEMS

SCMs are not be constructed within 75 feet of a public or private potable water supply well or within 15 feet of an onsite wastewater disposal and treatment system.

PERMANENCE OF VEGETATED BUFFERS

Permanent protection of the vegetated buffer in its natural state must be afforded through an easement or other legal instrument. Legal access for maintenance must also be ensured.

PROJECTS WITH LARGE PAVED AREAS

Projects such as shopping centers, large highway intersections, and high-density development must provide for oil, grease, and sediment removal.

5.4. Structural Stormwater Control Methods

5.4.1. Soil amendments

DESCRIPTION AND APPLICABILITY

Soil amendments are substances added to soil to change its physical and/or chemical properties. They may be used in a variety of SCMs for several different purposes. Amendments such as compost may be used to increase porosity and water holding capacity in soils, particularly to restore infiltration in compacted soils. Other types of amendments are recommended for bioretention SCMs to reduce nitrate loads discharged into the groundwater. Amendment characteristics, therefore, must be matched to their intended function.

The soil's pH affects the chemical form and availability of nutrients and the type of microbes present. Coastal soils formed from limestone, marl, or seashells are generally alkaline, while soils in pine flatwoods are acidic. Concrete or stucco residue left from building materials can also make soils around homes alkaline. Acidic soils reduce the availability of potassium, calcium, and magnesium, all of which are needed for healthy plant growth. The availability and mobility of metals such as aluminum, iron, and zinc are also increased at lower pH levels.

If plants are to be grown in an amended soil, the pH must be suitable for the plants being used. To raise the soil's pH, either lime (calcium carbonate) or pelletized dolomite (calcium magnesium carbonate) can be used. Testing must be done before they are added, however, to determine the buffering capacity of

⁷⁹ South Florida Water Management District. (2016). *Environmental resource permit applicant's handbook*.

the soil and calculate how much is needed. Healthy plants can naturally further improve soil quality, increasing soil porosity, infiltration rates, and groundwater recharge.

UNIT PROCESSES

Compost removes phosphorus through ion exchange and sorption processes. Other types of amendments may have different characteristics. Increased organic material promotes biological activity and aids plant uptake of nutrients.

DESIGN CRITERIA

The quantity and type of soil amendment needed will depend on its intended application, the contributing pollutant sources, and the water quality goals at a particular site. Resources are available from suppliers to assist in design.

EFFECTIVENESS

Compost is the most common soil amendment. In addition to increasing infiltration rates, it increases the soil's water holding capacity and reduces erosion of sandy soils. It gradually releases nutrients that can be easily absorbed by plants and supports helpful microbes in the soil. Compost added to compacted sandy soils has been shown to increase porosity by 41% to 48%, in turn increasing infiltration rates by factors of 1.5 to 10 over compacted soil. Total phosphorous was reduced by 70% and total nitrate was reduced by 7%. However, compost may initially leach nutrients until the soil stabilizes.⁸⁰



Figure 5-2. Compost for soil amendment. (Lifesoiils)

Where soils are sandy with low organic content, amendments with compost under turf grasses and landscape beds can noticeably improve the health of the landscape, with the potential to reduce water and fertilizer usage and resultant nutrients into surface and groundwater.

Some amendments may be suitable in specific types of soil, such as clays. Although clay is not common in Southeast Florida, it does occur in the marl (calcium carbonate "mud") found in low lying areas in south Florida. It has a high pH (generally between 7.4 and 8.4), high concentration of calcium carbonate, and is very poorly drained. Gypsum (hydrated calcium sulfate) can be added to clay soils to increase porosity, as it reacts with clay to create larger granules and, therefore, larger spaces around the particles. Gypsum also increases calcium and sulfur levels in the soil and removes sodium salts, reducing hardpan, without changing the pH.⁸¹

A mix formulated by the University of Central Florida Stormwater Academy containing peat, sawdust, tire crumb, crushed limestone, crushed oyster, and wood chips was found to be very effective at removing nutrients. In tests, three soil types were amended: sandy loam, loamy sand, and sandy clay loam, and with a residence time of five hours, the total phosphorus removal exceeded 99% for influent concentrations between 0.5 and 5.0mg/L. The important components for phosphorus removal were

⁸⁰ Low Impact Development, Center, Inc. (n.d.). *Soil amendments: watershed benefits*. Retrieved from http://www.lid-stormwater.net/soilamend_benefits.htm

⁸¹ Low Impact Development Center, Inc. (n.d.). *Soil amendments*.

believed to be tire crumb, limestone, and fine clay particles. Nitrate removal ranged from 95% to 65% at 0.5 mg/l to 5.0mg/L influent concentrations. While this is just one possible mix, it illustrates that a combination of substances amended to soil or incorporated with other SCMS has the potential to achieve high levels of nutrient removal.⁸²

Other proprietary soil amendments are available, including “Bold and Gold” mixes developed by the University of Central Florida’s Stormwater Management Academy. Their biosorption activated media composed of sand, clay, and recycled tire crumb have shown removal rates of up to 75% of nitrogen and up to 95% of phosphorus and suspended solids, with an expected life of up to 30 years.⁸³

NEW DEVELOPMENTS/TRENDS

Biochar is a promising soil amendment similar to activated carbon that can be created from a variety of materials, including several that are readily available in Southeast Florida, such as sugarcane bagasse, horse shavings, palm fronds, and yard waste. The feedstock is heated in a low or no-oxygen environment, breaking it down into a hydrogen-rich gas that can be burned for fuel and a high carbon residue, the biochar. The quality and performance of the product can vary greatly depending on the type of feedstock and process temperature; however, it has been found to be more effective than other organic materials used to amend soil in reducing many contaminants found in stormwater.⁸⁴ Research is ongoing to optimize the process for various feedstock types and applications, and proprietary mixes are being marketed.

The mechanisms for pollutant removal vary depending on many factors, and not all are currently understood. For example, ammonia N is adsorbed, but the nitrate N removal process is unclear. In addition to pollutant removal, biochar was found to increase the hydraulic performance of vegetated swales by retaining larger volumes of stormwater and allowing extended time for infiltration.⁸⁵

Biochar can be used in LID applications using bioretention (swales, filter strips, treatment ponds, constructed wetlands, and infiltration planters) or filtration (sand filters, underdrains, catch basin inserts). It has potential to be an effective and relatively low-cost alternative to remove contaminants, including nitrogen, phosphorous, heavy metals, organic compounds, and E. coli bacteria from stormwater.

5.4.2. Green roofs

DESCRIPTION AND APPLICABILITY

Green (vegetated) roofs are used in conjunction with cisterns to reduce stormwater volume and peak discharge rates. They may be credited as stormwater retention systems; however, their stormwater benefits may be ancillary to the energy savings and extended roof life offered by green roofs. They are

⁸² Program for Resource Efficient Communities. (2011, September 30). *Alachua County Draft LID Manual*. University of Florida IFAS Extension.

⁸³ Environmental Conservation Solutions. (2018). Enhance nutrient reduction in BMPs. Retrieved from <https://ecs-water.com/stormwater-management/bold-and-gold-stormwater/>

⁸⁴ Jehangir, H., & Bhadha, S. J. (2018, April 5). *Producing biochar using a custom designed Top-lit Updraft (TLUD) gasifier*. Retrieved from <http://edis.ifas.ufl.edu/ss626>

⁸⁵ Tian, J. (2016). *Biochar addition to stormwater treatment media for enhanced nitrogen removal and hydraulic performance*. Retrieved from <http://biochar-us.org/presentation/biochar-addition-stormwater-treatment-media-enhanced-nitrogen-removal-and-hydraulic>

primarily applicable in dense urban areas where green spaces may be lacking. Public, commercial, and office buildings, as well as multi-family housing, are all potential sites for green roofs.

BENEFITS

Green roofs with cisterns have multiple functions; they attenuate peak flows, reduce runoff volumes, and provide filtration and retention to decrease annual pollutant loads. They may either store filtered water for non-potable reuse, or the filtrate may be discharged to another SCM as part of a stormwater treatment train. In addition to the stormwater functions, green roofs insulate the building and reduce interior energy use. They also reduce urban heat island effects and extend the life of the roof. Most commonly used on public or commercial buildings, access to extensive green roofs can provide green spaces for the building occupants. However, they are expensive to construct, the roof strength must be sufficient to support the extra weight, and there are operation and maintenance concerns to consider.

The retention capacity of green roofs and cistern systems determines their available treatment volume, but some extra capacity must be provided to supply irrigation to the roof during dry periods. For locations that discharge to impaired waters or those with an adopted TMDL, the treatment volumes to achieve a variety of load reduction efficiencies can be determined based on the percentage of directly connected impervious area (DCIA) and the weighted curve number for non-DCIA areas. Appendix E of the 2010 Draft Statewide Stormwater Applicant's Handbook has tables calculating mean annual mass removal efficiencies for specific rainfall amounts based on these variables. South Florida is considered as Meteorological Zone 5. Design examples are also provided in Section 23 of the Handbook.⁸⁶

Based on an analysis of 55 years of rainfall records in Miami, about 42% of the annual rainfall would be expected to be retained by a green roof without a cistern. With a cistern, the relationship between storage volume (measured in inches over the area of green roof) and the percent of annual retention is given by a best-fit equation (Figure 5-3).⁸⁷

⁸⁶ Messer, N. (2010, March). *Draft environmental resource permit stormwater quality applicant's handbook*. Department of Environmental Protection and Water Management Districts. Retrieved from https://fdotwww.blob.core.windows.net/sitefinity/docs/default-source/content2/roadway/drainage/files/stormwaterqualityapphb-draft.pdf?sfvrsn=579bf184_0

⁸⁷ Messner. (2010, March). *Draft environmental resource permit stormwater quality applicant's handbook*.

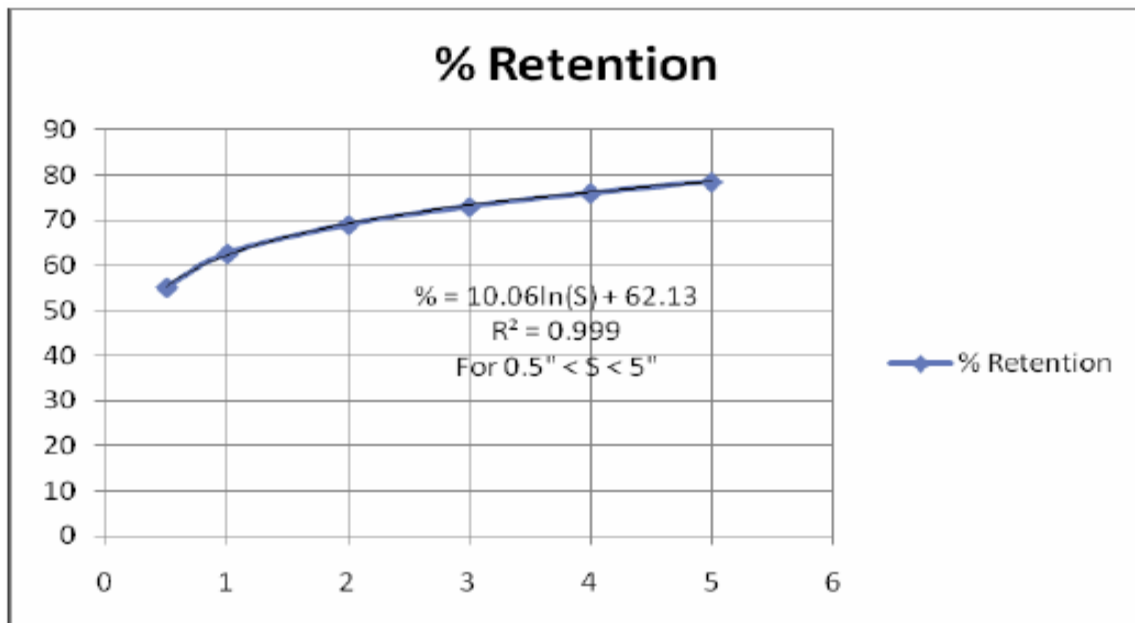

Figure 5-3. Percent annual runoff retention for given cistern storage volume, in inches over green roof area.

DESIGN CRITERIA⁸⁸

The two types of green roofs, extensive (Figure 5-4) or intensive (Figure 5-5), have slightly different design criteria. An extensive green roof is shallower (growth medium and pollution control layers combined are 6 inches or less), supports smaller plants, and is not intended for public access. Intensive green roofs have root zone depths greater than 6 inches and require an additional protection layer.

- **Waterproof membrane** - The waterproof membrane layer can be made of various materials, but must be rated as providing root protection, and it must be installed according to the manufacturer's installation instructions.
- **Drainage layer** - The drainage layer can be constructed of aggregate with no more than 7% fines (smaller than #200 sieve) by mass, or geo-synthetic drainage mat or other material, provided it allows lateral movement of the filtered water, provides adequate support to the media layers, and the water's resulting pH remains between 5.5 - 8.5.
- **Separation fabric** - A separation fabric of a non-woven geotextile material covers the drainage layer to prevent the pollution control media filling its voids and clogging it. The fabric must have a hydraulic conductivity greater than 1.5 inches per hour.

⁸⁸ Wanielista, & Livingston. (2016, September). *Escambia County LID BMP Manual*.

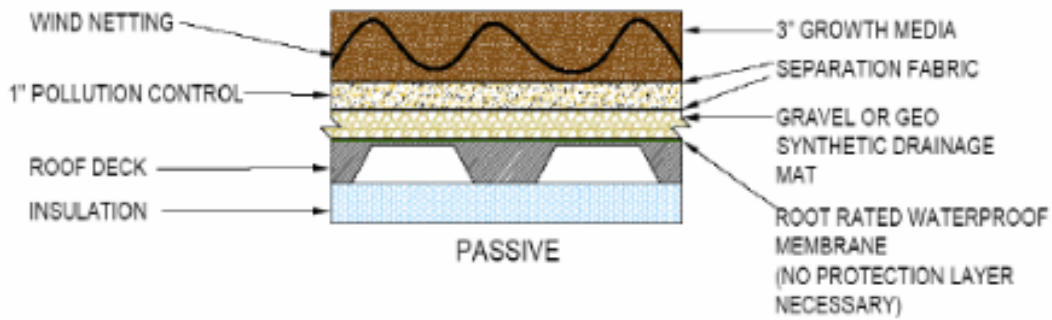

Figure 5-4. Section view of an extensive green roof (usually no public access and minimal management).

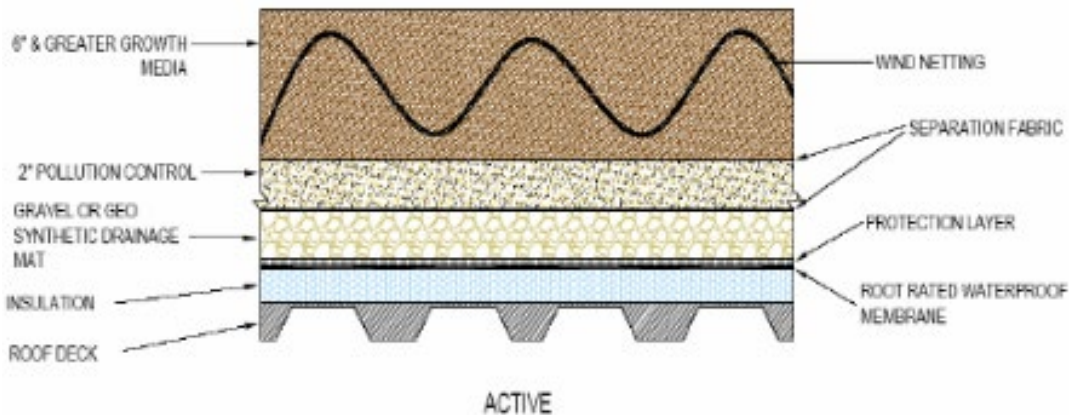

Figure 5-5. Intensive green roof section (usually active function).

- **Pollution control media** – The following criteria is used by Escambia County for pollution control media. Some variation in media content may be advisable to adsorb pollutants present at a specific location.
 - The layer must be at least 1 inch deep
 - The media must have 5% fines or less
 - Water holding capacity is at least 30%, as measured by porosity
 - Permeability is at least 1.5 inches per hour
 - Dry unit weight must be 45 pounds per cubic foot or less
 - Organic content is no more than 10% by volume
 - pH between 6.5 and 8.0
 - Soluble salts must be less than 3.5 g (KCL)/L
 - Sorption capacity must exceed 0.005 mg OP/mg media
- **Growth media** – The growth media rests on top of the separation fabric and must meet the same criteria as the pollution control media, with the following changes:
 - The layer must be at least 3 inches deep
 - The media must have 10% fines or less
 - All other criteria are unchanged from the pollution control media
- **Plants** – Native plants are generally recommended, but they must also be tolerant of drought, high heat, and direct sunlight. Salt tolerance may also be required near the coast. Within one

year of planting, coverage of the roof should be 80% or more. A few examples that have been used successfully include: Beach Sunflower, Blanket Flower, Butterfly Weed, Perennial Peanut, Sunshine Mimosa, and Snake Weed.

- **Irrigation** – Drip irrigation is used. Pumps should have rain sensors and an alarm to indicate mechanical malfunction. A flow meter is needed to record the irrigation frequency and volume.
- **Roof drain** – An interior drain or gutter can empty to an above- or below-ground cistern for irrigation water storage. A secondary overflow is also required as a backup in case the first drain becomes clogged.
- **Cistern** – The cistern volume must accommodate the irrigation needs of the roof at a minimum and may store extra water for reuse onsite. Excess filtrate water drains to other SCMs. Above-ground cisterns must be UV-stable and be placed away from direct sunlight to prevent overheating of the water.

UNIT PROCESSES

Green roofs function primarily as detention/retention systems, rather than for removal of pollutants. They can buffer acid rain, although this is not a significant problem in Florida.

EFFECTIVENESS

The effectiveness of green roofs in reducing pollutant loads is directly related to the volume of stormwater that is retained and reused, either taken up by vegetation, transpired or evaporated, or stored and reused elsewhere for irrigation. Excess filtrate may also be discharged to other SCMs as part of a treatment train. Green roofs also attenuate peak runoff rates.

If not amended by suitable media, nutrient concentrations in filtrate from green roofs are generally increased over levels from standard roofs due to fertilizers and organic matter in the soil, so fertilizer use should not be excessive.

EXAMPLE

The Miami-Dade Children’s Courthouse has areas of an extensive green roof (Figure 5-6).



Figure 5-6. Views of the green roof at Miami-Dade Children's Courthouse.

NEW DEVELOPMENTS/TRENDS

Blue roofs are not vegetated, but they use trays or other methods to retain water, which is released slowly into a cistern or a bioretention area. Many of their benefits are similar to green roofs if stormwater is discharged to bioretention, but they avoid the plant maintenance of green roofs.⁸⁹

5.4.3. Cisterns and rainwater harvesting

DESCRIPTION AND APPLICABILITY

The term “rainwater harvesting” most commonly refers to water collected from roofs or other impervious surfaces that is stored in either above-ground or below-ground vaults or cisterns and reused as non-potable water. Rain is a free source of relatively clean, soft water; however, as rain falls onto surfaces such as concrete, pavement, and grass, it is likely to pick up more contaminants than it would from contact with roofing materials. Harvesting rainwater is an easy, inexpensive way to disconnect impervious surfaces and capture water before it has contacted potential contaminants.

The purpose of capturing and reusing stormwater is to replace the use of potable water. Usually, harvested rainwater is used for outdoor irrigation, but it can be used for a variety of activities, ranging from outdoor irrigation and car washing to indoor toilet flushing, clothes washing, and irrigation for indoor planters. With appropriate treatment, it may also be used for potable use. The cost of harvested rainwater in new developments has been estimated to be about 5%–25% of the cost of potable water.

Harvesting rainwater requires a cistern, pump, flow meter, and some type of filtration system, depending on the intended use for the water. It is appropriate for use in areas ranging from rural to moderately high densities, as cisterns can be located above or below ground if space is limited.

BENEFITS

Capturing rainwater and storing it for use reduces the volume of stormwater discharged to the treatment system and may allow smaller pond volumes, with associated land and cost savings. Peak flow rates may also be reduced. Roof capture of rainwater avoids contaminating of that portion of the runoff, eliminates the need to treat it elsewhere, and increases overall treatment effectiveness. Rainwater harvesting reduces demand for potable water and avoids the expense of treating and transporting potable water for irrigation and other non-potable purposes. Finally, it provides groundwater recharge if used for irrigation.

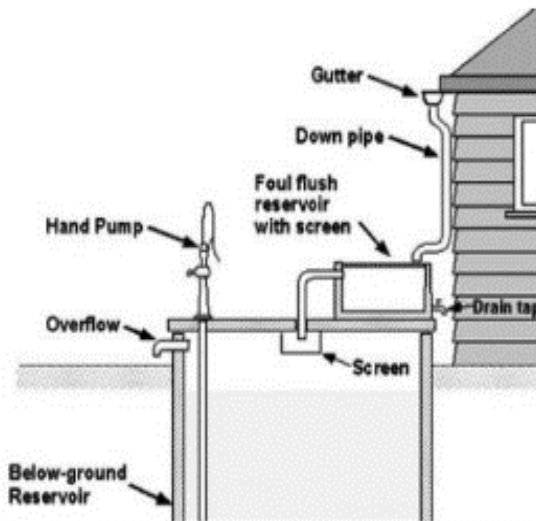

Figure 5-7. A cistern for storing rainwater.

⁸⁹ NOAA Office for Coastal Management. (2015). *Green infrastructure options to reduce flooding, definitions, tips, and considerations*. Retrieved from <https://coast.noaa.gov/data/docs/digitalcoast/gi-econ.pdf>

UNIT PROCESSES

Because rainwater harvesting doesn't pick up pollutants from the ground surface in the same way that other stormwater does, it may not need any treatment beyond filtration. Depending on the type of reuse, disinfection may be required. If the water is to be used as potable water, precipitation, coagulation, and flocculation may also be used to remove suspended solids.

EFFECTIVENESS

Depending on the size of the cistern, rainwater harvesting provides moderate to high volume and pollutant reduction.

DESIGN CRITERIA

Approximately 600 gallons of water can be collected per inch of rainfall per 1,000 square feet of roof area. However, the "first flush" of runoff from each storm is likely to have higher levels of pollutants. To capture this, the first 10 gallons per 1,000 square feet from each storm is diverted to landscaped areas. This may sound like an insignificant amount of runoff, but for small amounts of rainfall, the proportion of discarded first flush runoff will be relatively large, and some storms may not produce enough runoff to have excess stored in the cistern. For small rainfall totals, the diverted amount will be 8.3% of 0.2 of an inch or 33% of 0.05 of an inch. Large storms that produce more runoff than the cistern capacity will need to bypass excess runoff. Over a year, the amount able to be harvested is estimated to be about 75% of the total rainfall.

Rain barrels (typically ~50 gallons) are not considered to be cisterns, as their individual volume is too small to make a significant difference in runoff volume or water quality. However, their use is encouraged, as they generally increase awareness and can slightly reduce potable water use.

- **Initial screen** - A screen must be provided to remove any debris or sediment before water enters the cistern.
- **Cisterns** – The following criteria must be met:
 - UV-stable and able to inhibit algal growth without adding biocides or toxic substances to the water. An opaque tank can serve this purpose.
 - Access must be provided for inspection and cleaning, but humans or animals must be prevented from entering the cistern.
 - Very large cisterns may need to have an OSHA Confined Entry permit and meet other safety criteria.
 - If underground, must be designed to resist buoyant forces from high water tables. (Septic tanks may be converted to cisterns after being disconnected from previous use.)
- **Greywater systems** - For use in toilet flushing and laundry:
 - Extra filtration and disinfection are required. Particles should be removed to a level between 5 and 20 microns through two-step filtration, pre-filtering before water enters the cistern and fine filtering between the pump and the indoor plumbing system.
 - A backflow preventer is required.
 - Roofs covered with asphalt shingles or cedar shakes are not suitable for graywater use, as they can leach toxic chemicals into the water.
- **Equipment** - A pump system and flow meter are needed for harvested rainwater.
- **Overflow drain** - An overflow drain should pass a 100-year, 24-hour design storm discharge.

EXAMPLES

A car wash in New Hope, Minnesota will use rainwater harvesting and water reuse to offset their water use. It is expected to save millions of gallons each year, in the range of 50%–90% of their total usage. Separate cisterns, with a total volume of 100,000 gallons, will store harvested rainwater and captured wash-water for reuse. The cost of \$50,000 for the system is expected to be recouped through reduced water and sewer expenditures.⁹⁰

Nocatee, a master planned community in Duval and St. Johns counties, began harvesting stormwater in 2010. They withdraw water to irrigate 308 acres from 14 wet retention ponds, supplemented with reclaimed wastewater. The current system is estimated to save about 182 million gallons of groundwater each year and there are plans to double the size of the system.⁹¹

NEW DEVELOPMENTS/TRENDS

The potential for rainwater harvesting is vast and has been rarely considered in most development. It is widely used in other parts of the world but is uncommon in the United States. Concern for water purity and dependable supply volumes are impediments, as is the cost to retrofit systems in existing buildings. However, where potable water supplies are scarce or treatment costs escalate, rainwater harvesting systems are sustainable alternative sources.

5.4.4. Underground storage and exfiltration

DESCRIPTION AND APPLICABILITY

Underground storage and exfiltration systems capture stormwater in an underground storage system, where it is held until it can infiltrate into the underlying soil. They may be called underground tanks, vaults, or chambers, and many commercial models are available. Generally, these systems consist of lightweight, high-strength modular units with “open” bottoms to allow for soil infiltration (Figure 5-8).

BENEFITS

Relatively large volumes of stormwater may be stored and infiltrated into the soil, and downstream pollutant loads are reduced through volume reduction. The land above the storage tanks is available for other uses, such as parking lots or pedestrian areas. Exfiltration tanks require suitable soil and sufficient depth above seasonal high groundwater to allow infiltration.

⁹⁰ New Hope, Minn., Car Wash Implements Rainwater Harvesting. (2019, January 14). Retrieved January 29, 2019, from <https://www.estormwater.com/rainwater-harvesting/new-hope-minn-car-wash-implements-rainwater-harvesting>

⁹¹ St. Johns River Water Management District, Stormwater harvesting GIS Tool. (n.d.). Retrieved February 26, 2019, from <https://www.sjrwm.com/data/stormwater-harvesting/>

UNIT PROCESSES

Physical filtration of pollutants is provided by soil particles, and microbial activity reduces dissolved nutrients. Metals, hydrocarbons, or bacterial contaminants are also removed through adsorption to soil particles or microbial breakdown of the compounds.

EFFECTIVENESS

All pollutants in the volume of infiltrated stormwater are removed from downstream surface flow, although there is potential for groundwater contamination if insufficient soil depth is available for effective treatment.

DESIGN CRITERIA

- The following criteria should be followed:
- The storage capacity must be able to contain the treatment volume without considering soil storage.
- Inspection ports or observation wells are necessary to monitor their performance after rainfall.
- Vaults may not be located under buildings or in locations where access is not possible or within 50 feet of a well supplying potable water.
- Trash screening and a sedimentation chamber are needed immediately upstream of an underground retention system to minimize interior clogging.
- Projects using underground vaults must be owned by a single owner or have full time maintenance staff to operate them.

EXAMPLE

The FDOT captures stormwater runoff from bridges over Southeast Florida estuaries in underground vaults. One of these is the Flagler Memorial Bridge in West Palm Beach.

5.4.5. Permeable pavements

DESCRIPTION AND APPLICABILITY

Permeable or pervious pavements are modified versions of standard pavements that allow water to flow through the surface. These include asphalt, concrete, concrete pavers, structural turf, or various other designs, but all provide both storage and treatment of stormwater in the graded layers beneath the surface pavement. After passing through, water can infiltrate into the ground or be collected and discharged to another part of the stormwater system.



Figure 5-8. Installation of underground exfiltration media, Madera subdivision, Alachua County, Florida. [Photo, UF-PREC]

Permeable pavement systems are generally made up of up to five material layers: 1) permeable pavement, 2) bedding coarse, 3) choker coarse, 4) reservoir base coarse (combined base and reservoir subbase layers), and 5) soil subgrade. Systems designed for managing stormwater runoff generally have a common profile below the pavement surface (Figure 5-9).

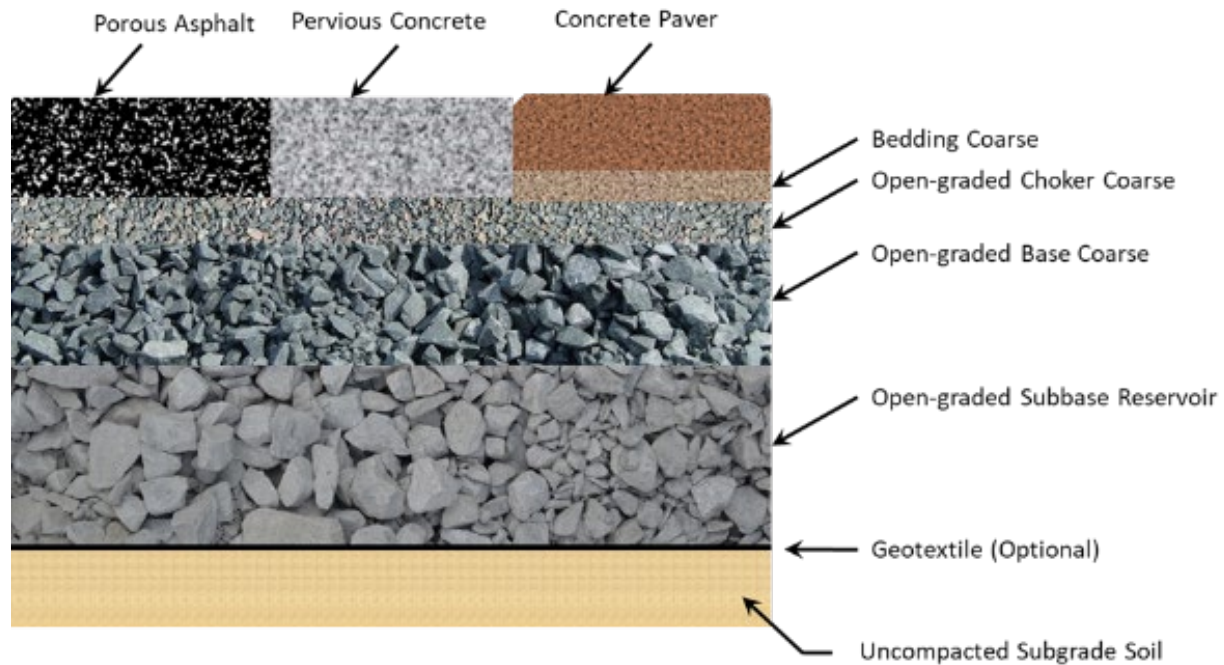

Figure 5-9. Typical cross section of permeable pavement.

Permeable pavements are most applicable to areas receiving light duty traffic loadings, with infrequent heavy vehicular traffic. This includes residential feeder streets, low-intensity commercial parking lots, roadway shoulders, pedestrian and bicycle paths, and on-street parking stalls. In addition, areas where vehicles must frequently turn should avoid permeable pavement materials, as these can shift, crack, or spall.

Permeable pavements can be used for treatment where subsurface conditions are not compatible with infiltration when an underdrain system is added. A perforated pipe under the storage reservoir collects treated stormwater and discharges it. It can also be suitable for multi-family, commercial, etc. parking in dense developments where land is not available for large-scale ponds.

Mulched landscaped beds should not be located immediately adjacent to permeable pavements to reduce the risk of debris being transported onto the surface, causing clogging. Trees that drop a lot of leaves and/or flowers should also be avoided in close proximity for the same reason.

BENEFITS

If they are correctly designed, constructed, and maintained, permeable pavements provide effective removal of most stormwater pollutants. They also attenuate peak runoff rates and reduce the total volume if infiltration is used. Where conditions are not suitable for infiltration, permeable pavements can be used with an underdrain system. Though these options are more expensive than standard pavement,

they offer stormwater management without the need for additional land area. They also can help reduce the urban heat island effect.

UNIT PROCESSES

Pollutants are removed through physical entrapment in the pavement, as well as by absorption and adsorption. If an underdrain system is not used, pollutant loads and runoff volume are reduced through infiltration.

EFFECTIVENESS

Permeable pavements provide effective removal of nutrients and metals. The credited load reductions will depend on the volume of stormwater retained at a specific site. Without retention, they can provide detention and some nutrient reductions. They are used in conjunction with other SCMs in a treatment train.

DESIGN CRITERIA

A pervious pavement system has two major components: structural and hydraulic. It must be able to support the traffic loading and, equally important, must function properly hydraulically. This section does NOT discuss structural designs of pervious pavement systems. Some of the specifications and recommendations to sustain good hydraulic function in the pavement system are listed below.

- **Minimum depth to groundwater** - The seasonal high groundwater table must be at least two feet beneath the bottom of the pervious pavement system, unless an alternative design can be demonstrated as being more appropriate for the specific site conditions based on plans, test results, calculations, or other documented information. The “system” is defined as the pervious pavement itself, the underlying storage reservoir, if used, and the geo-fabric that wraps the underlying storage reservoir.
- **Vertical hydraulic conductivity** - The minimum vertical hydraulic conductivity of all layers in the system must be 2 inches per hour or greater if specified in the design.
- **Distance to potable wells** - Pervious pavement systems must be at least 50 feet away from any potable water supply well.
- **Redevelopment projects** - If pervious pavements are proposed within redevelopment projects, any existing pavement section and its compacted base must be removed, and the underlying soils scarified to at least 16 inches. The site must be re-graded, filled with hydraulically clean soils (if applicable), and proof rolled to a maximum compaction of 92%–95% Modified Proctor density (ASTM D-1557).
- **Maximum slope** - The maximum slope for pervious pavements is 1/8 inch per foot (although zero percent slope is preferred) unless the pavement is for a walkway, bicycle path, or driveway ingress or egress areas. Steeper slopes must be justified to demonstrate that they are appropriate for the site conditions and that they provide equivalent treatment and protection. The primary concern is to maintain the hydraulic ability of the system to percolate stormwater into the underlying sub-soil.
- **Perimeter barrier** - The horizontal movement of water can cause scour failure at the edge of a pervious pavement system, or it may mask the hydraulic failure of the system if the deeper voids in the pervious pavement or aggregate reservoir become plugged. To prevent this, a hydraulic

barrier is needed around the perimeter of pervious pavements, extending at least eight inches below the bottom of the pavement.

- **Allowed ponding depth** - To provide an indicator that the pervious pavement system has failed or needs maintenance, the system must be designed to allow a minimum ponding depth of one inch and a maximum ponding depth of two inches prior to down-gradient discharge with the exception of pervious walks and bicycle paths.
- **Overflow provision** - An overflow must be provided at the nuisance ponding elevation to the down-gradient stormwater treatment or attenuation system or outfall.
- **Contributing landscaped areas** - Runoff from adjacent landscaped areas must not be directed onto pervious pavements if it will increase the potential for clogging the pervious pavement. The design must reduce the likelihood of plugging the pavement void spaces with silts and sands.
- **Embedded Ring Infiltrometer Kits (ERIK)** - One or more ERIK is required to be installed (except on walkways and bicycle paths) to monitor the hydraulic function of the pervious pavement system. Their location(s) must be shown on construction plans, and documentation must be provided on their construction and post-construction testing.
- **Vacuum sweeping** - For proper maintenance of most pervious pavement systems, periodic vacuum sweeping is recommended. It is required at least annually or when infiltration performance declines so that the vertical hydraulic conductivity rate falls below the permitted rate or is less than 2.0 inches per hour, or when nuisance ponding occurs. Vacuum sweeping also will be required for areas that are subject to wind transported soils (for example, near sand dunes) or other places where excessive soil or debris deposition is expected.
- **Remediation plan** - A remediation plan is required and must be implemented if vacuum sweeping fails to sufficiently improve the pavement's performance (a vertical hydraulic conductivity rate greater than 2.0 inches per hour and equal to or exceeding the permitted design percolation rate, and any nuisance ponding is resolved). Maintenance records must be kept as part of the required O&M re-inspections and certifications.
- **Water quality credit** - Credit for pervious pavement walks and bicycle paths may be allowed to encourage their use. For soils with SHGWT depths of 0 inches to 18 inches below the bottom of the pervious pavement system, 80% of the pervious pedestrian walk and bike path areas can be subtracted from the total contributing area when computing the project's required treatment volume. The total area can also be subtracted if SHGWT depths exceed 18" below the bottom of the pervious pavement system.
- **Walkways and paths** – Perimeter hydraulic barriers, vacuum sweeping, remediation plans, and ongoing O&M re-inspections and certifications are not (normally) required.

EXAMPLE

Permeable pavements were used at a [PNC Bank branch](#) in Ft. Lauderdale and are being incorporated as part of multiple LID measures for water quality treatment and stormwater volume reduction in several drainage basins by the city.

NEW DEVELOPMENTS/TRENDS

A national standard, [ASCE/ANSI 68-18 Permeable Interlocking Concrete Pavement \(PICP\)](#), has been released by the American Society of Civil Engineers Transportation & Development Institute (ASCE T&DI) covering design of PICP in areas with saturated subgrade soils. PICP may be suitable for application in many areas of Southeast Florida.

5.4.6. Exfiltration/infiltration trenches and dry wells

DESCRIPTION AND APPLICABILITY

Exfiltration or infiltration trenches, tanks, and dry wells are subsurface retention and infiltration systems made up of perforated storage pipes or modular tanks embedded in aggregate. The volume of the pipes or tanks and pore spaces in the aggregate function to store runoff until it can be infiltrated into underlying soils. They reduce the volume and peak discharge rate from a site by storing a significant volume that can be infiltrated at a slow rate into the ground. They function like small, underground retention ponds.

While the terms exfiltration and infiltration are opposites, in stormwater management they both refer to water soaking into the ground, with the point of view as the major difference. A rock-filled trench in which water enters from the surface might be termed an infiltration trench, while an exfiltration trench is fed through a pipe entering the middle of a trench and is focused on the flow of water out of the trench (as it infiltrates into the soil). Functionally, there is little difference between the two.

The trenches may be normally dry if sufficient depth above groundwater is available, or they may be periodically or constantly wet if the seasonal high groundwater table intersects the bottom of the aggregate reservoir beneath the distribution pipe or tank. If they are wet, a larger surface area is needed to achieve the same storage volume within the aggregate.

Exfiltration trenches are suitable to convey and distribute captured runoff from sites ranging from large commercial parking lots to individual residences. Modular units can be located under residential lawns. Soils must have sufficient permeability for the design infiltration. Pipes and tanks can be made of concrete or lightweight plastic; the entire trench area is lined with a geotextile fabric.

BENEFITS

Exfiltration trenches reduce stormwater volume and remove pollutants as runoff percolates into underlying soils. They are good for removing treatment volumes and are calculated to meet a specific percent removal efficiency based on the project's percentage of directly connected impervious area (DCIA) and the weighted curve number for non-DCIA areas. Exfiltration trenches must be designed to have the capacity to retain the required treatment volume without discharging to ground or surface waters.

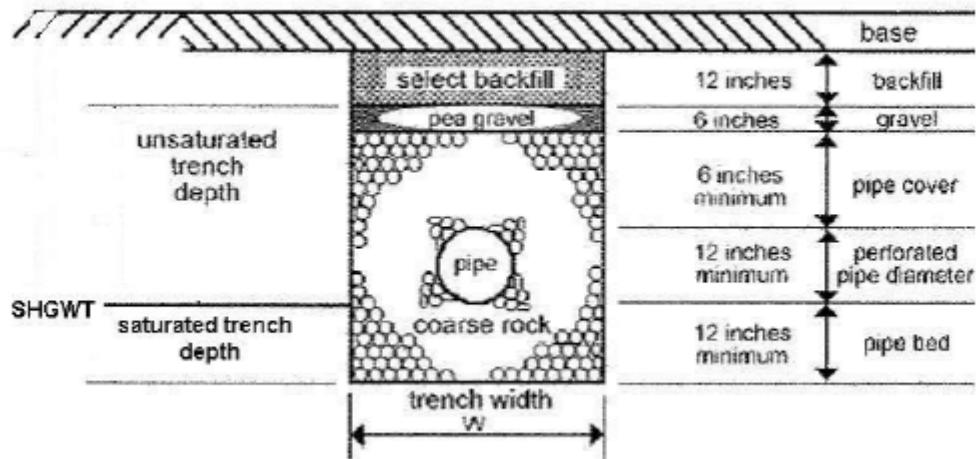

Figure 5-10. Typical wet infiltration trench.

UNIT PROCESSES

Filtration is the primary treatment process. It removes suspended solids, metals, phosphorus, organics, dissolved nutrients and bacteria. In many cases, sedimentation is needed by another SCM prior to stormwater entering the trench to remove large solids and prevent clogging in the trench media.

EFFECTIVENESS

Exfiltration trenches' effectiveness will depend on the design volume reduction. SFWMD requires onsite test data to credit subsurface exfiltration, which must show the ability to recover the treatment volume as specified. They recommend test procedures from the Dade County Department of Environmental Resource Management and Florida Department of Transportation.

DESIGN CRITERIA

The following design criteria should be followed:

- **Recovery of treatment volume** – Trenches must be able to recover the treatment volume in one hour, with a safety factor of two.
- **Ownership** – Generally, exfiltration trenches are only permitted for projects operated by single owners or entities with full-time maintenance staffs.
- **Treatment volume** – The aggregate reservoir and perforated pipe are sized to hold the required treatment volume. The available storage volume in the aggregate reservoir must be calculated using the sustainable void spaces. Aggregate void space must be the larger of 35% of aggregate volume or 80% of the measured testing lab values for the selected aggregate(s).
- **Trench dimensions and specifications** – The following are the proper dimensions and specifications for trenches:
 - Trench width is usually a minimum of 3 feet.
 - Perforated pipe diameter must be a minimum of 12 inches.

- A maintenance sump, at least 24 inches deep, should be provided to collect trash and other inflow debris on all system inlets and manholes. A screen or other feature is also needed to prevent trash, debris, or oil/grease from entering the trench.
- The material used in the aggregate reservoir should be washed to assure that no more than 5% of the materials pass through a #200 sieve.
- A permeable filter fabric should surround the aggregate reservoir on all sides to exclude neighboring soil. The permeability of the filter fabric must be greater than the permeability of the adjacent soil.
- **Relationship to water table** – Invert elevations of dry exfiltration trenches must be at least two feet above the seasonal high groundwater table elevation to assure recovery of the Required Treatment Volume (RTV). Alternative designs can be approved on case-by-case basis if appropriate for the specific site conditions.
- **Wet exfiltration trenches** – These are allowed only within Miami-Dade County because of their unique aquifer characteristics.
- **Monitoring access** – Suitable access is needed to inspect the storage media and perforated pipe to ensure that the system is functioning as designed, i.e., maintaining the design infiltration rate and storage volume. The type of access may vary, but systems commonly have one of three options:
 - The end of a perforated pipe or storage area terminates in an accessible drainage inlet or manhole.
 - An inspection port at least eight inches in diameter is installed at the terminal “dead end” of a perforated pipe or storage area.
 - An observation well is provided.
- **Distance to potable water** – Exfiltration trenches cannot be constructed within 50 feet of a public or private potable water supply well.

EXAMPLE

By 2014, the [City of Fort Lauderdale](#) had about 16 miles of exfiltration trenches throughout the city on both public right of ways and on private property.

5.4.7. Bioretention cells

DESCRIPTION AND APPLICABILITY

“Bioretention systems are shallow, landscaped depressions with soil and vegetation that are typically smaller in size and frequently distributed throughout a contributing area.”⁹² It is a flexible approach that can be located in many settings, with a common function that bioretention receives runoff from impervious areas and treats stormwater primarily through infiltration and plant uptake of nutrients, metals, hydrocarbons and bacterial pollutants.

⁹² Horsley Witten Group. (2018). *Boynton Inlet Contributing Area Watershed Management Plan* (p. 88). Palm Beach County, Florida: NOAA Fisheries Service. Retrieved from <http://www.horsleywitten.com/wp-content/uploads/2017/03/BoyntonICAWatershedMgmtPlan.pdf>

Bioretention is suitable for use in natural or existing low areas, allowing minimal reshaping of the site. It is a good decentralized method of source control for stormwater in residential developments but can also be used in parking lot islands or landscaped areas in commercial or public areas.

Rain gardens are small, shallow retention basins that are integrated into a site's landscaping and are planted with deep-rooted Florida-Friendly or native plants. They slow down the rush of water from impervious surfaces by containing the water for a short period of time, thereby allowing it to naturally infiltrate into the ground or evaporate. Provisions must be made for high flows to drain into a swale or piped system. Rain gardens are generally used only when the contributing drainage area is less than three acres, and they are not recommended in areas where slopes are 10% or greater.

Bioretention can be used in curb bump-outs or medians along city streets, as well as in parking lot islands. Infiltration planters and tree boxes are other types of bioretention, but those are discussed separately. Bioretention is not suitable if there is less than two feet of separation between the seasonal high water table and the bottom of the bioretention area, unless an alternative design can be shown to be appropriate for the specific site. Where infiltration rates are below 0.1 inches per hour, bioretention must be designed with underdrains or soil augmentation to improve function.

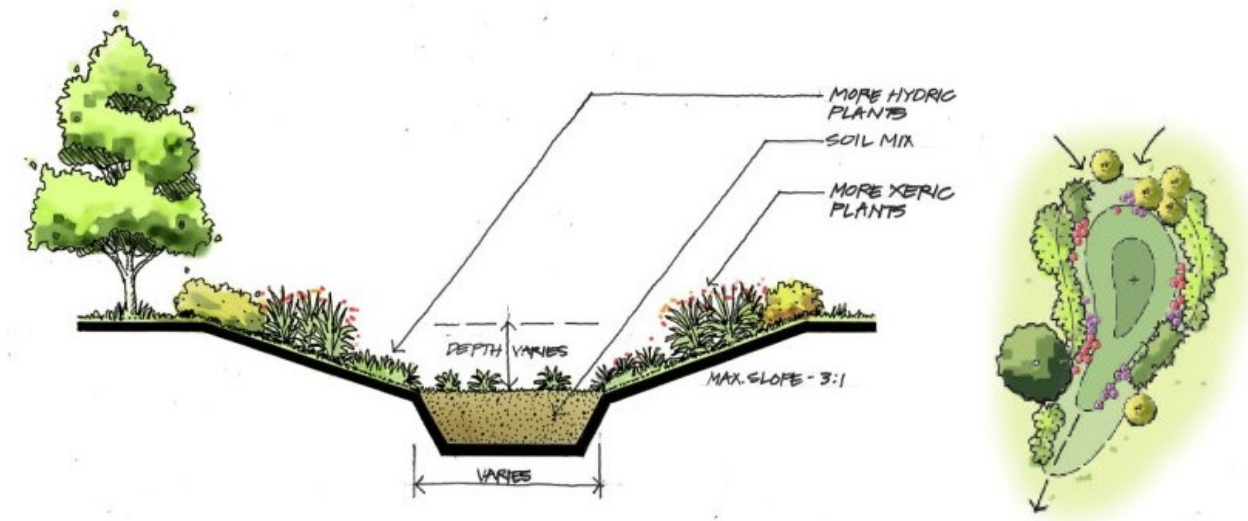

Figure 5-11. Typical cross-section of a bioretention area. Plan view of a rain garden.

BENEFITS

Benefits include pollutant removal, site runoff reduction, reduced irrigation for planting beds, increased biodiversity in the landscape, benefits to wildlife, aesthetic benefits to neighborhoods, increased property values, and psychological benefits of green spaces to urban residents.

UNIT PROCESSES

Design of bioretention may provide sedimentation in a shallow forebay of a pond or at the entrance to smaller bioretention areas. The combination of soil, microbes, and vegetation provide filtration, adsorption, ion exchange of solids and metals, as well as biological absorption and decomposition of

organics and nutrients present in the stormwater. Pathogens are removed by a variety of chemical and biological processes as well as through disinfection from ultraviolet radiation.

DESIGN CRITERIA

Bioretention areas should have screenings for trash and debris, and often a small influent area is designed to trap larger particles and allow for easy sediment removal during maintenance. Soil amendments are also recommended in most locations.

EFFECTIVENESS

As a retention SCM, the volume of stormwater retained and whether the SCM is located online or offline will determine the specific level of treatment. Soil amendments may enhance pollutant removal.

5.4.8. Buffer strips

DESCRIPTION AND APPLICABILITY

A buffer strip is a vegetated area that stormwater flows across before it enters a water body (either natural or another SCM) to filter some pollutants ahead of the downstream water. They are typically 25–50 feet wide and may be used above natural wetlands or in conjunction with permeable pavements or exfiltration trenches. If being used for retention, the SFWMD allows credit for up to 0.2 inches of storage.

BENEFITS

Buffer strips protect downstream water bodies by reducing suspended solids and nutrient loads. They also may provide natural vegetation for wildlife habitat, reduce heat island effects, and improve air quality.

UNIT PROCESSES

Filtration and nutrient uptake occur as stormwater passes through a vegetated strip. Some biological treatment and infiltration also take place on plant surfaces and in their root zones.

DESIGN CRITERIA

Buffer strips design criteria include the following:

- The area within the buffer strip must contain existing natural vegetation suitable for infiltrating stormwater and soil stabilization.
- Requirements for the minimum width of buffer strips around wetlands and other sensitive lands will differ by the type of land being protected and may vary between different local governments. The SFWMD requires a minimum 25 feet upland buffer around wetlands.
- Buffers should be uniformly graded with flow distributed evenly across the surface to allow sheet flow through the buffer. The contributing area should not exceed a width of 300 feet, and the buffer width should not be greater than 100 feet, also for the purpose of maintaining sheet flow through the buffer.
- Native or Florida-friendly plants should be used within the buffer.
- Buffer strips may require permanent legal protection from development.

EFFECTIVENESS

Buffer strips have been estimated to remove about 20%–25% of nutrients and 50% of suspended solids.

5.4.9. Infiltration planters and tree box filters

DESCRIPTION AND APPLICABILITY

Infiltration planters and tree boxes are a small-scale variation of bioretention areas and are known by a variety of names: flow-through planters, tree box filters, and street tree wells. Typically, a planter consists of a concrete vault containing zones for soil and mulch in which the vegetation is planted, aggregate for stormwater storage, and an underdrain system with inlet and outlet to collect treated runoff and/or bypass excess flow.

Stormwater from surrounding impervious areas is directed into planters, treated as it flows through, and stored temporarily until it is discharged. If the bottom of the planter is open, then discharge is through infiltration to the surrounding soil. If the box is closed, then filtered stormwater can flow into an underdrain system and be discharged to either another LID BMP or a piped system. The planter functions as a filter and either a detention or retention BMP.

Many configurations are possible: boxes may have open sides or open floors, and adjacent catch basins may overflow into the box below the surface. Inlets can be from gutter openings, catch basins, or piped drains from roofs, parking lots, or other areas. Pretreatment can be provided with the addition of biochar or other specialized media for removing pollutants in the soil or in entry pipes or sumps that empty into the infiltration boxes/trenches. Proprietary products are available for tree boxes or smaller plants, marketed as “urban rain-gardens.”

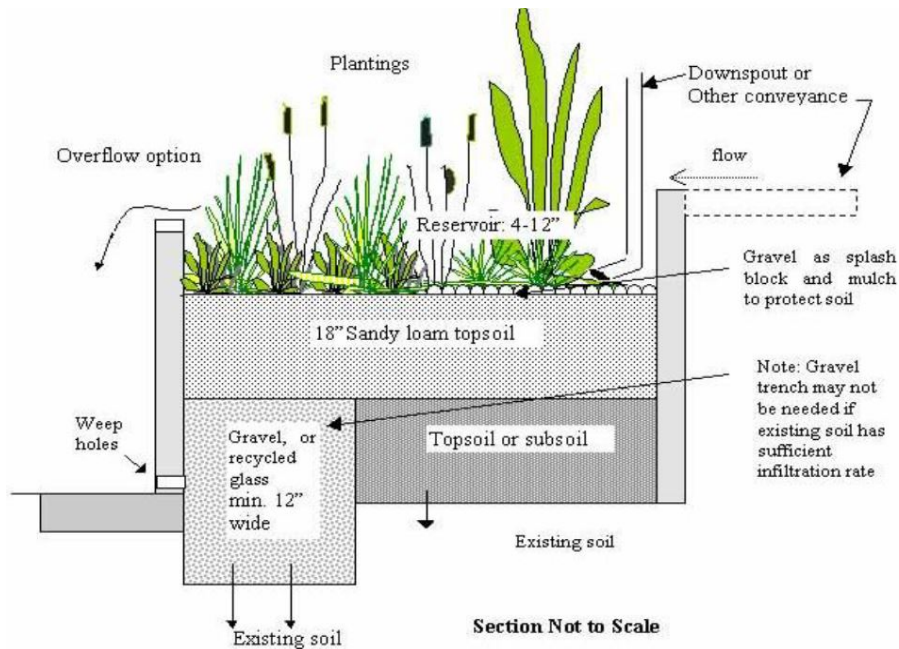

Figure 5-12. Sample design for an infiltration box.

Infiltration planters and tree boxes are appropriate for new projects or can be retrofit into existing stormwater systems. If a perforated pipe is added to the design to collect treated stormwater, these planters can be used in areas with high groundwater or where soils are not suitable for infiltration. The composition of soil both in and under the planter/box must be evaluated; an amendment with compost

or other media is usually recommended to improve moisture retention and microbial action. Other soil amendments may be required to increase removal of hydrocarbons and metals or other specific pollutants.

If trees are to be planted, the volume of soil provided must be carefully considered and must be adequate for root development. Otherwise, the tree's health may be impacted. Growth of street trees may also be limited by the smaller volume of soil available. Trees should have high resistance to wind and be tolerant of periodic inundation. In areas that could be subjected to storm surge or saltwater intrusion, trees must also be salt tolerant.⁹³ The SFWMD publishes a list of trees that may be considered in south Florida landscapes.⁹⁴

BENEFITS

The flexibility and compactness of vegetated planters are adaptable to many locations. They reduce runoff volume and peak flow rates from the site by storing a portion of the flow, which can be taken up by the vegetation.

Sediment, nutrients, and other pollutants are removed by vegetation and micro-organisms in the soil and media. Air quality is improved, and the heat island effect is lessened. In addition, infiltration planters are a desirable aesthetic amenity. On the downside, they may require more frequent inspection and care of plants than some other stormwater SCMs.

UNIT PROCESSES

The combination of soil, microbes, and vegetation provide filtration, sedimentation, adsorption, ion exchange of solids, and metals as well as biological absorption and decomposition of organics and nutrients present in the stormwater

EFFECTIVENESS

Infiltration planters and tree boxes are capable of capturing suspended solids and heavy metals carried by stormwater. In one study, a 20% reduction in stormwater volume resulted in 80% or more reduction in TSS.⁹⁵ Some nutrients are also removed by filtration and biofilms within aggregate storage reservoirs.

NEW DEVELOPMENTS/TRENDS

Innovative designs are incorporating infiltration planters into many different urban locations with structures modified to fit varied shapes and architectural styles, creating amenities in public areas (Figure 5-13). Tree trenches connect several boxes



Figure 5-13. Sidewalk infiltration planter box.

⁹³ Black, R. J. (2003). *Salt-tolerant plants for Florida*. University of Florida IFAS Extension. Retrieved from [https://www.capecoral.net/Salt tolerant Plants for Florida.pdf](https://www.capecoral.net/Salt%20tolerant%20Plants%20for%20Florida.pdf) (Originally published in 1985)

⁹⁴ South Florida Water Management District. (n.d.). *Below the surface, an in-depth look at storm wise south Florida landscapes*. Retrieved from https://www.sfwmd.gov/sites/default/files/documents/bts_stormwise_landscapes.pdf

⁹⁵ Geronimo, F. K. F., Maniquiz-Redillas, M. C., & Kim, L.-H. (2013). Treatment of parking lot runoff by a tree box filter. *Desalination and Water Treatment*, 51(19–21), 4044–4049. <https://doi.org/10.1080/19443994.2013.781099>

underground to allow a larger area for roots and stormwater retention. Collection and underdrain piping may be simplified. Modular, pre-fabricated units are available, and specialized filters or soil amendments may be used to target particular pollutants if needed.

In urban locations with very limited space, structural soil can be used to allow tree roots adjacent to roadways to grow under pavement and prevent compaction of the soil from traffic above. These typically are composed of about 80% crushed rock and 20% soil. Other techniques to serve the same purpose are structural cells or suspended pavement. These use proprietary structural cells or concrete pillars to support the pavement and prevent compaction of underlying soil from heavy vehicles.⁹⁶

5.4.10. Vegetated swales

DESCRIPTION AND APPLICABILITY

Swales are shallow channels used to collect and transport stormwater (conveyance swales), most frequently along roadways, but they may be used on any site where adequate space is available. Vegetated swales are planted with suitable, stabilizing vegetation that acts to slow runoff and promotes infiltration as well as improve water quality through sedimentation and filtration as the flow moves through the swale. They should only contain standing or flowing water for short periods after a rainfall event.

Vegetated swales can function primarily for transporting stormwater to a downstream SCM (conveyance swales), acting to slow runoff and allow some infiltration. However, if check dams are added, then they function as a series of narrow bio-retention basins, sometimes called a linear retention system. They are then designed using the same requirements as other retention SCMs. Raised driveway culverts can function as check dams with no additional expense.

BENEFITS

Swales reduce stormwater volume, peak discharge rate, pollutant loadings, and heat island effect. Depending on the design, swales may also provide sedimentation, infiltration, and limited dissolved nutrient removal. They allow groundwater recharge and enhance site aesthetics. In many cases, they can be integrated into landscaping. By replacing standard curb and gutter and piped systems, they slow peak



Figure 5-14. Vegetated swale at the University of Florida's SW Recreation Center.

⁹⁶ Minnesota Pollution Control Agency. (2018, September 25). *Tree trenches and tree boxes combined* - Minnesota Stormwater Manual. Retrieved from https://stormwater.pca.state.mn.us/index.php?title=Tree_trenches_and_tree_boxes_combined

flow rates, even where retention is not an option. However, due to their width requirements, they are not suitable for dense urban areas.

UNIT PROCESSES

Biological removal of dissolved nutrients occurs through the action of microorganisms as well as direct uptake by vegetation. Sorption of metals, bacteria, and nutrients occur as stormwater infiltrates through soil or other media. Suspended particles are removed through sedimentation, although resuspension during subsequent high flows is possible, particularly if check dams are not present.

EFFECTIVENESS

Swales typically can remove up to 85% of total suspended solids, about 40%–75% of metals, and approximately 30%–40% of total phosphorus and 20%–40% of total nitrogen. Re-suspension of sediment can lower these percentages, however.

DESIGN CRITERIA

Design criteria for swales includes the following:

- **Swale dimensions** - A top width-to-depth ratio of the cross-section is typically equal to or greater than 6:1 horizontal to vertical, or side slopes equal to or flatter than 3:1 horizontal to vertical. The bottom width is usually 2-8 feet.
- **Water quality depth** - Design water quality depth about 4 inches.
- **Vegetation** - Suitable plants should cover the bottom and sides of the swale, stabilizing the soil stabilization and affording high rates of nutrient removal.
- **Soils** - The site must have appropriate soil and SHGWT conditions for infiltration and amended soils are recommended under the infiltration surface area.
- **Underdrain system** - If soils are poorly drained, then an underdrain system composed of a perforated pipe in a ¾-in gravel base over a filter fabric can be used for treatment before discharge to a piped collection and treatment system.
- **Location restrictions** - Swales should not be constructed within 75 feet of a public or private potable water supply well or within 15 feet of an onsite wastewater disposal and treatment system. Swales are not appropriate on sites with potential hazardous or toxic materials.
- **Other design considerations** - The soil erodibility, soil percolation, slope, slope length, and drainage area should be considered to prevent erosion and reduce pollutant concentration of any discharge.

Infiltration and nutrient uptake are enhanced if a series of check dams or swale blocks are added. The swales then function as a series of narrow bro-retention basins, as described in Section 5.14.1.

EXAMPLE

- The University of Florida's SW Recreation Center features a vegetated swale across the front of the site. The steeper sections have narrow gravel section along the channel invert, and the sides are planted with grasses and wetland plants. In addition to providing a functional stormwater path, the swale includes sculptural elements.

5.5. Flow Control Stormwater Control Methods

Flow control devices modify the path of stormwater runoff or its velocity as it moves into an SCM. They may hold water back, separate first flush flow from the main flow path, or dissipate energy and slow the velocity. Four types are described here, each serving different functions. Other options are also possible.

5.5.1. Check dams

DESCRIPTION AND APPLICABILITY

Check dams are used to detain small volumes of stormwater to allow sedimentation and infiltration as well as to reduce the velocity of flow through a channel or basin. They may help to reduce peak flow rates from low to moderate intensity storms.

A common use of check dams is in vegetated swales, where they are placed in a series producing a chain of small detention/retention basins. In residential areas with roadside vegetated swales, raising the invert elevations of driveway culverts by 6–12 inches above the swale base elevation at each point will allow each culvert to act as a check dam. Check dams may be constructed of any stable material, such as stone or concrete, with a central weir and energy dissipating measures on the downstream side to prevent erosion. A larger check dam at the entry point to a stormwater treatment pond can create a forebay at to provide pretreatment by slowing the flow and facilitating sedimentation.

BENEFITS

Check dams slow runoff and attenuate peak flows. They create opportunities for longer detention and infiltration in swales that would otherwise mostly function to transport stormwater.

UNIT PROCESSES

Check dams slow stormwater velocity, allowing particulates to settle by gravity.

EFFECTIVENESS

Check dams in swales are credited based on the amount of retention volume they provide. Note that swales without check dams have been credited for one-half of this volume.⁹⁷

5.5.2. Flow splitter boxes⁹⁸

DESCRIPTION AND APPLICABILITY

Flow splitter boxes are used ahead of offline SCMs to control the flow of stormwater into the SCM. They are open to the offline SCM so that all initial flow goes directly into it. However, after the water level in the downstream SCM reaches the design treatment volume level, a weir inside the splitter box lets additional runoff overflow into a bypass pipe, where it rejoins the main drainage flow path (Figure 5-15). Variations on the design are possible.

⁹⁷ State Erosion and Sediment Control Task Force. (2013, July). *Erosion and sediment control designer and reviewer manual*. Florida Department of Transportation and Department of Environmental Protection. Retrieved from https://fdotwww.blob.core.windows.net/sitefinity/docs/default-source/content2/roadway/drainage/files/erosion-sediment-control.pdf?sfvrsn=719d1965_0

⁹⁸ Massachusetts Department of Environmental Protection. (n.d.). *BMP factsheets: flow splitter*. Retrieved from <http://pri.geosyntec.com/npsmanual/flowsplitter.aspx>

BENEFITS

By directing the first flush to an offline retention SCM, what is usually the highest concentration of pollutants are captured and retained for removal. Bypassing additional stormwater prevents short circuiting and resuspension of settled solids.

UNIT PROCESSES

If the design includes a stilling chamber, then some sedimentation occurs within the splitter box. Otherwise, they are pass-through structures.

EFFECTIVENESS

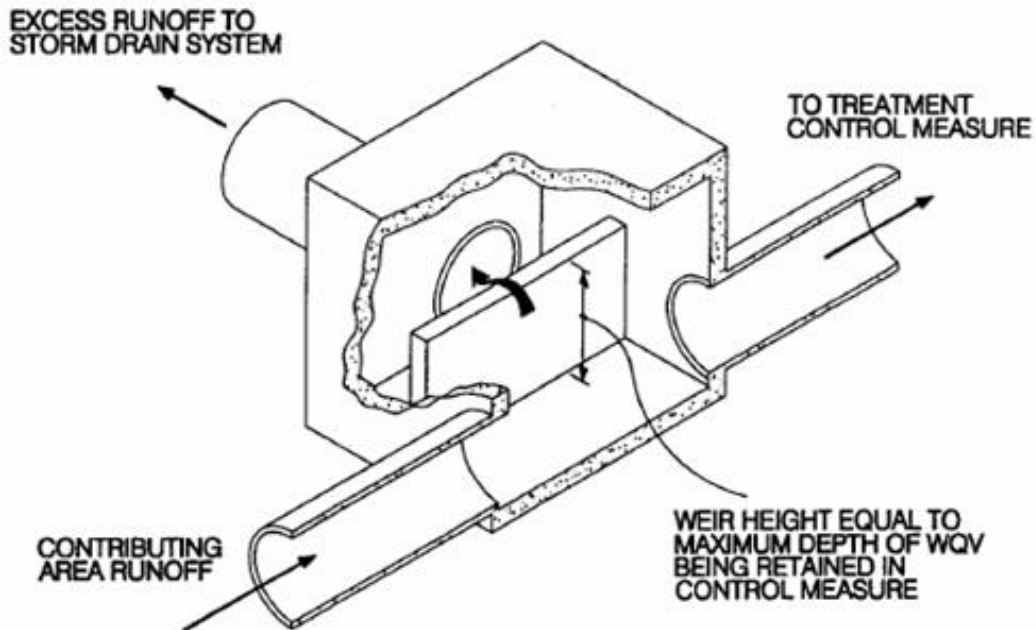

Figure 5-15. Diagram of a simple flow splitter box. (Source: Massachusetts Clean Water Toolkit)

Splitter boxes do not provide any stormwater treatment themselves beyond limited sedimentation. However, they improve the performance of a subsequent retention SCM by separating the required treatment volume to an offline process and enabling the first flush of runoff to be retained.

5.5.3. Flow spreaders

DESCRIPTION AND APPLICABILITY

Flow or level spreaders are used to distribute stormwater evenly across a surface to create sheet flow. There are two main functions and many variations in spreader designs. They may be used to direct influent flow to another stormwater SCM, for instance to spread stormwater across a buffer strip for pretreatment before it enters a stormwater pond, protected wetland, or pervious pavement. In order to direct influent flow into a vegetated slope, a shallow sill or berm (made of earth, concrete, PVC pipe, or other suitable material) is constructed lengthwise across a slope (Figure 5-16). Water backs up behind it and overflows evenly onto the vegetated surface below. In a variation for sub-surface infiltration, stormwater overflows into an aggregate filled infiltration trench. Water is dispersed through the trench and infiltrates into the soil, primarily through the bottom and downstream side of the trench.

Flow spreaders may also be used to redistribute concentrated outflow from an SCM to prevent erosion. Impervious areas are sloped so that stormwater drains to one point where it is collected and directed to an inlet leading to a perforated distribution pipe. Flow is then distributed across a vegetated area for treatment. An aggregate filled infiltration trench may be part of the design, located immediately before the spreader lip. A level spreader lip

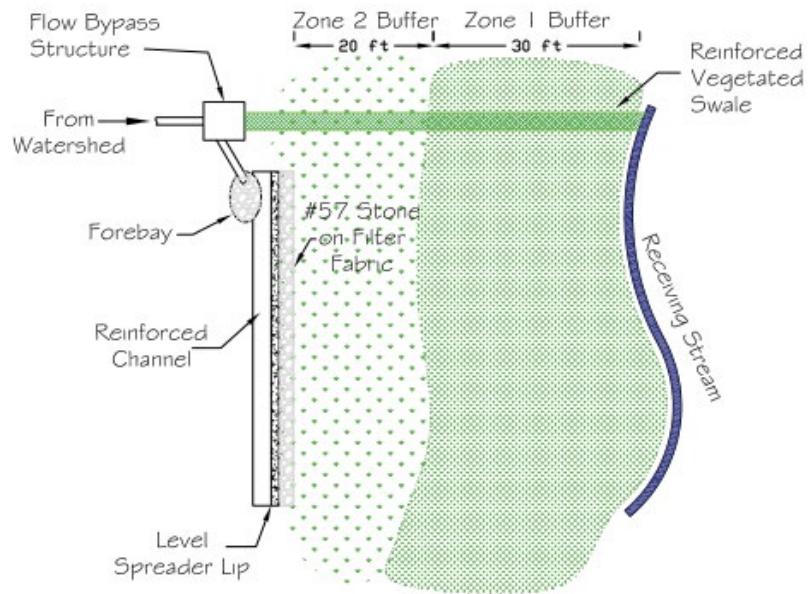

Figure 5-16. Level spreader distributing stormwater to buffer strip.

BENEFITS

Flow spreaders reduce flow velocities and prevent erosion and short-circuiting that often occur from more concentrated flows across the ground surface. They reduce peak flow rates and may provide sedimentation. If the design incorporates an infiltration trench, some volume reduction may also occur.

UNIT PROCESSES

If present, forebays allow particles to settle by gravity. Infiltration, which may be minimal or significant depending on the design, provides physical filtration, and biological processes in the soil reduce contaminants.

EFFECTIVENESS

The effectiveness of treatment will depend on the volume of water that may be infiltrated if the design includes an infiltration trench.

DESIGN CRITERIA

Whether they are above-ground sills or perforated pipes embedded in shallow aggregate filled channels, spreaders must be level across the slope to provide uniform flow. Spreaders should be sized to carry a 10-year design storm or as required by the permitting authority. The length of the distribution pipe will vary by site location, but multiple inlets and spreaders are likely to provide a more even flow distribution than would be attained with a single longer spreader pipe.⁹⁹ Although many design variations are workable, some general recommendations¹⁰⁰ include:

⁹⁹ Bureau of Watershed Management. (2006). Chapter 6.8.1 BMP Level Spreader (No. 363- 0300-002). In *Pennsylvania stormwater best management practices manual* (p. 642). Pennsylvania Department of Environmental Protection. Retrieved from <http://www.depgreenport.state.pa.us/elibrary/GetFolder?FolderID=4673>

¹⁰⁰ Hathaway, J. H., & Hunt, W. F. (2006). *Level Spreaders: overview, design, and maintenance* (Urban WaterWays No. E07-45839) (p. 7). North Carolina Cooperative Extension. Retrieved from <http://chesapeakestormwater.net/wp-content/uploads/downloads/2012/01/LevelSpreaders2006.pdf>

- The lip of a spreader must not be an erodible material, and its ends must connect with higher elevations to prevent flow bypassing around the spreader.
- A design rule of thumb for the spreader length is 13 feet per cubic foot per second (cfs) stormwater flow rate to prevent erosion from high velocities, but this may be adjusted depending on the erodibility of downstream vegetation and the amount of infiltration expected.
- Vegetation receiving flow downstream of a level spreader must be well-established and stable before operation begins.
- A forebay lined with aggregate may be incorporated in the design to capture sediment if needed. If present, it should be sized to hold 0.2% of the runoff from the contributing impervious area.

5.5.4. Splash blocks at pipe outlets

DESCRIPTION AND APPLICABILITY

Splash blocks or riprap are used to dissipate the energy of rapidly moving water at influent locations for bio-treatment SCMs. They are primarily used with swales, ponds, and bioretention islands, but are appropriate at any point where excess velocities may occur.

BENEFITS

Splash blocks prevent scour or resuspension of accumulated sediment at influent points to stormwater SCMs or where steep slopes or changes in slope could lead to erosion.

DESIGN CRITERIA

Splash blocks may be constructed of natural stone, concrete, or other durable material.

5.6. Flow-through SCMs

5.6.1. In-stream bioreactors

DESCRIPTION AND APPLICABILITY

In-stream bioreactors are structural water quality treatment systems that are incorporated into waterways and rely on physical and chemical processes to improve water quality. These structures were first applied in agricultural settings in the mid-west to treat agricultural drainage water with high nutrient concentrations, but more recently they have been incorporated into perennial and ephemeral streams in piedmont and coastal plain settings to treat base flows with high nutrient concentrations.

This type of system can be designed to remove nitrogen and/or phosphorus. They are best sited in channels with low energy that constantly hold water to saturate the bioreactor. Slow flow rates are ideal, as they allow for longer residence times within the bioreactor leading to greater nutrient removal.

BENEFITS

In-stream bioreactors can treat low, chronic nutrient concentrations in slow velocity settings. They can be incorporated into a channel, canal bed, or bank. They provide passive treatment without any energy inputs.

UNIT PROCESSES

Nitrogen removal is typically accomplished through denitrification by providing an organic (wood chips) material with a high C:N ratio. When the material is continuously saturated, the water will become anoxic, and the nitrogen-limited media will force bacteria to remove NO₃ from the water column,

converting it to a gas, typically N₂. Incorporating bioreactors into the channel bed promotes continuous saturation and anaerobic conditions.

Phosphorus removal is typically driven by adsorption to Fe or Al oxides on the surface of media in the bioreactor. Anaerobic conditions can cause P to be released if Fe and or AL are reduced. Denitrifying media and adsorptive media need to be replaced over time as they are consumed or saturated, respectively.

EFFECTIVENESS

In-stream bioreactors have not been tested in south Florida waterways and are still an emerging technology. However, similar treatment systems that rely on baseflow through an engineered treatment media, such as Regenerative Stormwater Conveyance, have shown promising effectiveness at reducing nutrient loadings.

DESIGN CRITERIA¹⁰¹

In-channel bioreactors are designed to have baseflow through the bioreactor while allowing storm flows to pass without significant scour or sedimentation. Following the design of Robertson and Merkley (2009), the reactor is typically slightly narrower than the channel bottom. Most bioreactors are approximately 66 feet long and 3 feet deep. The channel bottom is excavated based on the bioreactor dimensions.

- Approximately 80% of the volume is filled with coarse permeable wood chips. The remaining 6-8 inches on the upstream half is filled with ½ – 1 inch of gravel over the upstream half of the reactor, while the lower end is filled with a low conductivity silt or finer soil to limit vertical flow.
- A 4-inch perforated PVC pipe is aligned width-wise across the end of the bioreactor and connected to outlet pipe that discharges downstream of the reactor.
- At the end of the bioreactor, just above the outlet pipe, a 12-inch deep cobble berm is installed to back water up and force a driving head through the upper end of the gravel media. Adjusting the elevation of the outlet pipe controls the flow rate and residence time of flow in the bioreactor.

The anaerobic conditions should facilitate denitrification of nitrate in the stream flow. Hydraulic analysis should be performed to determine the size of cobble and the likelihood that flows will exceed thresholds for transport and scour. To remove phosphorus, amend the upstream gravel with iron or aluminum particles to bind phosphate. This region should remain aerobic to prevent a reduction in iron or aluminum and phosphate release.

NEW DEVELOPMENTS/TRENDS

In-stream bioreactors are an emerging technology that could be well suited for treating nutrients in south Florida's extensive canal system.

5.6.2. Filter systems

DESCRIPTION AND APPLICABILITY

Filter systems, particularly up-flow filters, are most often employed following detention systems to

¹⁰¹ Robertson, W. D., & Merkley, L. C. (2009). In-stream bioreactor for agricultural nitrate treatment. *Journal of Environmental Quality*, 38, 230–237. DOI:10.2134/jeq2008.0100

remove additional pollutants. They may be used with wet detention ponds, green roofs, storage vaults, or permeable pavements in locations where infiltration is not an option. Because they have a compact footprint and can be located underground, they are suitable for use in high-density urban areas.

A typical filter has a settling chamber for influent stormwater, with flow passing over a wall or weir then up through a submerged filter before being discharged through an effluent pipe. If the filter follows a previous detention SCM, then most sediment would already be removed, but the entry chamber provides extra protection to reduce clogging of the filter.

BENEFITS

Moderately high levels of pollutant removal can be achieved for most pollutants, which would not be possible where onsite flow retention is not an option due to high groundwater or unsuitable soils. Flexible design geometry, possible underground placement, and relatively compact volume requirements mean they may be used in many urban locations.

UNIT PROCESSES

As the name indicates, the process of filtration removes suspended solids and adhered pollutants from stormwater. If media other than sand is included, sorption processes remove specific dissolved pollutants depending on the properties of the media.

EFFECTIVENESS

Effectiveness will vary with the type of media, influent concentrations, and residence time in the filter. The BMPTRAINS program can be used to estimate overall effectiveness for alternative designs. As an example, removal rates of 50%–70% for total nitrogen and 74%–90% for total phosphorus have been reported for the combination of a wet pond (21-day residence time) and an up-flow filter using Bold & Gold media, depending on the filtration rate.¹⁰²

DESIGN CRITERIA

Design criteria for filter systems include the following:

- Media materials may include sand, wood chips, mulch or fibers, limestone, clay, coconut coir, tire crumb, pumice or many proprietary blends.
- A depth of 30 inches or more is recommended.
- Typical filtration rates are approximately 20 inches per hour, but slower rates increase residence time and may improve nutrient removal.
- For denitrification, the bottom portion of the filter must remain wet with anoxic conditions.
- A high flow bypass route must be provided.
- A flow meter is used to help schedule regular filter maintenance.

¹⁰² Wanielista, & Livingston. (2016, September). *Escambia County LID BMP Manual*.

5.6.3. Basin inserts

DESCRIPTION AND APPLICABILITY

Basin inserts function as in-line filters that remove particulates as stormwater passes through. They are typically installed within catch basins to filter storm water runoff before it enters a storm sewer system. They are typically made of filter fabric or metal screening that traps coarse particles and allows water to drain through. Absorbent material can often be incorporated into a basin insert to remove oil and grease. Due to their effectiveness for addressing oil, grease, and particulates, they are most applicable for catch basins within parking lots. Basin inserts can be an effective retrofit practice for existing storm drain systems. They require periodic replacement or clearing as they fill with sediment and debris. The frequency of replacement will depend on the material load draining to the catch basin inlet, and inserts should be checked regularly to evaluate their maintenance. Special equipment such as a forklift or front-end loader is often necessary to lift a filled fabric insert from a catch basin due to the weight of the accumulated material. Metal screen systems may be cleared via vacuuming.

BENEFITS

Basin inserts provide several benefits relative to other stormwater control measures:

- Sediment and particulate trapping.
- Absorption of oil and grease.
- Simple integration into existing infrastructure.
- No additional volume or area required for installation.

UNIT PROCESSES

The unit processes of basin inserts rely primarily on filtration and trapping of particulates. As the filter accumulates material, the weight in the center of the insert forces an inverted pyramid geometry. As water flows into a catch basin, particulates are filtered out as they settle to the bottom of the insert. Excess water flows through the filter fabric material primarily above the section where material has accumulated, although some flow is expected through the bottom. However, as material accumulates and traps finer and finer particulates, the flow is expected to decline over time.

Removal of oils and greases occurs by absorption. Absorbent media is typically integrated around the top of the basin insert so that the first volume of runoff can flow over and through this material, providing the greatest interaction between the runoff and the media's surface area. Hydrophobic oils and greases absorb to the absorbent media rather than remaining in an aqueous environment of runoff. The media eventually requires replacing as it becomes saturated from oil and greases over time.

EFFECTIVENESS

Basin inserts primarily trap sediment and other gross solids that may enter storm sewer systems. Incorporating absorbent media can also trap oils and greases very effectively. Dissolved contaminants, such as nutrients, metals, and bacteria are not typically removed with consistent efficacy by these measures. Further, trapped organic particulates, such as grass clippings and tree leaves, can break down during dry out periods between storm events. This has the potential to release organics and nutrients into the storm sewer system as dissolved contaminants. Thus, the inserts should be frequently maintained to remove this material from the storm sewer system.

DESIGN CRITERIA

Basin inserts are typically sized by vendors based on the geometry of standard-sized catch basin inlets.

5.6.4. Second generation (nutrient separating) baffle boxes

DESCRIPTION AND APPLICABILITY

Baffle boxes are typically underground flow through devices that are installed in-line with stormwater pipes and are designed to trap sediments and particulates and remove oils and greases from stormwater runoff. Vertical baffles separate the box into different sections. There are typically two to three sections within a box. Second generation (or nutrient separating) baffle boxes include a screen that intercepts stormflow as it enters the box and before it flows into the sedimentation sections, retaining organic debris. This prevents mobilization and export of nutrients from saturated organics within the box (Figure 5-17).

BENEFITS

Baffle boxes are installed in-line with stormwater pipes and, except for manholes, are completely underground. Though they can be included with new construction, they are ideal as a retrofit to address sediments and organics due to their minimal footprint and subterranean installation. Boxes can be maintained (cleaned out) using a vacuum truck to remove accumulated sediment and debris.

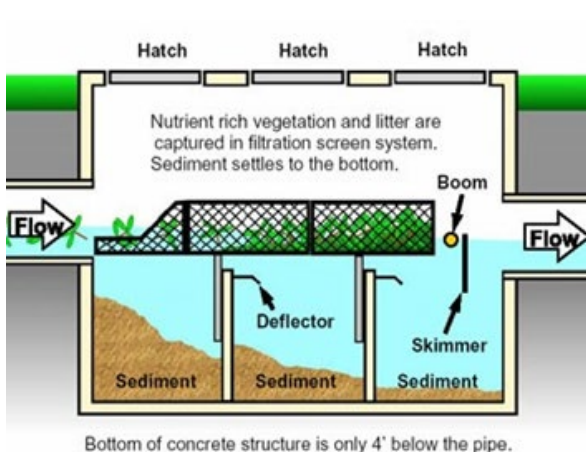

Figure 5-17. Second generation baffle box schematic and installation.

UNIT PROCESSES

Gross solids and organic debris, such as leaves and grass clippings, are retained on the screen as flow and smaller particulates flow through. Between stormflows, the water level within second generation baffle boxes falls below the screen elevation, limiting organic breakdown and nutrient export.

Stormflow then enters the first sedimentation section behind the first baffle. This allows coarse solids to settle out. Excess stormwater overflows into a subsequent sedimentation section to allow additional sedimentation to occur.

EFFECTIVENESS

Baffle boxes are most effective at removing sediments, though performance will vary across different site characteristics. Third-party evaluation studies have tended to report sediment removal rates of 60%–80%. Nutrient removal efficiencies are generally lower, typically <20%. However, effectiveness is highly dependent on regular maintenance of the system and quality characteristics of storm inflows.

DESIGN CRITERIA

Baffle box designs are based on the anticipated stormflow rates and inlet pipe sizes.

5.7. Off-lot Stormwater Control Methods

5.7.1. Infiltration basins

DESCRIPTION AND APPLICABILITY

Infiltration basins are normally dry retention ponds. They retain and treat stormwater through volume reduction and pollutant removal in the underlying soil. Basins are shallow and often blend into the landscaping of a site. The bottom and sides must be covered with stable vegetation; this is often turf grasses, but other ground covers can be used (Figure 5-18).

The desired treatment volume and infiltration rate are the primary factors that determine the basin size, and the basin must be able to infiltrate the volume within the specified recovery period (generally 72 hours with a safety factor of two). A mounding analysis is needed to ensure that infiltration will not be impeded by locally high groundwater.

Infiltration basins need permeable natural or amended soils and sufficient depth above groundwater—at least two feet above the SHGWT. Because a permanent pool is not required, dry infiltration basins require less volume than a wet bioretention pond to treat the equivalent amount of stormwater, but the land requirements may still be too large for some urban areas. They are appropriate for parks and campuses with open green space or common areas in residential developments. In areas where space is available but seasonal groundwater levels are high, the design may be modified to infiltrate through amended soils and collect stormwater in an underdrain system. Infiltration to groundwater is not appropriate for stormwater that may contain toxic substances.

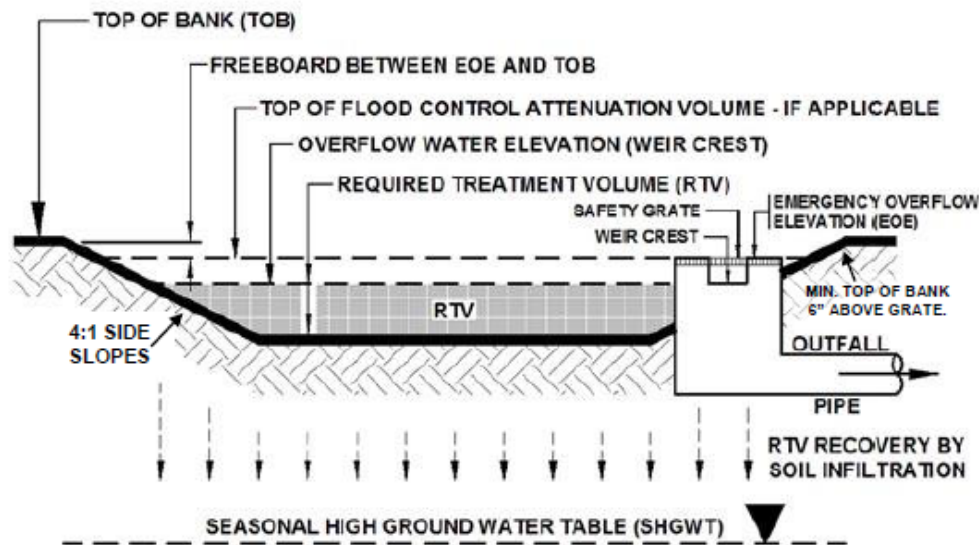

Figure 5-18. Typical cross-section of an infiltration basin.

BENEFITS

Infiltration basins decrease nutrient and other pollutant loads to downstream waters and effectively remove pathogens; however, dissolved nitrogen levels to groundwater may remain high, as significant denitrification may not be achieved. Maintenance needs are not intensive.

UNIT PROCESSES

Soil filters solids from the stormwater, while microbial action and sorption processes reduce other pollutants.

EFFECTIVENESS

Pollutant loads in the retained treatment volume are fully removed from surface runoff. There is potential for untreated pollutants migrating into groundwater if insufficient unsaturated depth is available below the basin.

DESIGN CRITERIA

- Design criteria for infiltration basins include:
- Side slopes are generally 4:1 horizontal to vertical.
- Basins may include flood control volume to detain high runoff volumes in excess of the treatment volume to be infiltrated.
- The maximum basin depth is controlled by a weir, overflowing to a high-flow bypass.
- The general design criteria for retention systems apply to infiltration basins as well.

5.7.2. Enhanced stormwater ponds

DESCRIPTION AND APPLICABILITY

Stormwater ponds are the mainstay of stormwater treatment in Florida. Standard treatment ponds can be normally wet or dry. Dry retention ponds have no permanent pool of water, but they are designed so

that the stormwater treatment volume is stored until it can infiltrate into the ground. Inflow larger than this is discharged through an overflow structure. The basin does not hold any water after drawdown has been completed, thus the system is normally “dry.” Underlying soil permeability and water table conditions must be such that the required treatment runoff volume can percolate the within a specified time following a storm event.

Wet detention ponds have a permanent pool and provide long residence times for treatment. Sedimentation removes particulate matter and most metals, but dissolved pollutants are not removed unless vegetation is present. They are used where water tables are high or where soils have poor infiltration capacity.

However, wet detention ponds have evolved from simple rectangles with grassed slopes to provide more effective treatment with shoreline vegetation, varying depths, and sedimentation forebays. They may contain multiple cells with varying depths creating a range of habitats such as hardwood swamps, shallow freshwater marshes, and deep water ponds. Enhanced stormwater ponds are multi-functional, incorporating physical design characteristics with vegetation to improve water quality treatment and create natural habitats in urban areas, as well as retaining the hydrologic benefits of standard treatment ponds. They are suitable for retrofits of existing stormwater ponds, as well as for construction in new developments.

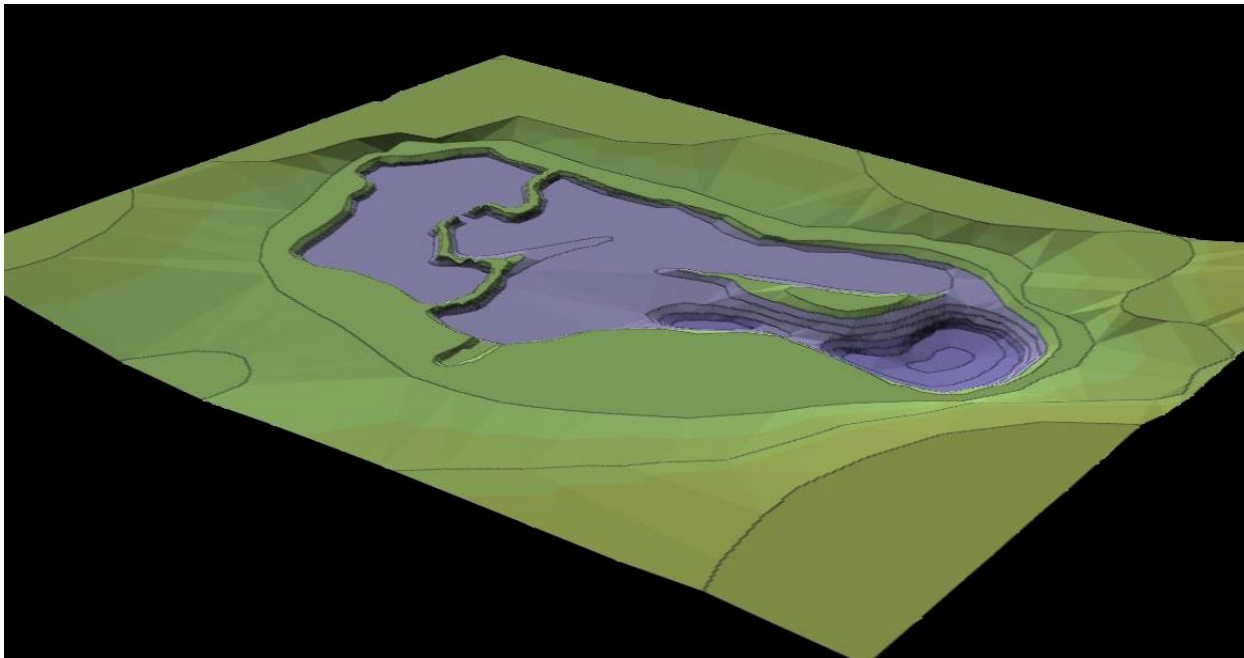

Figure 5-19. 3-D topographic plan for an enhanced stormwater pond. (Photo: UF PREC)

BENEFITS

The benefits of all types of retention basins include peak flow attenuation and a reduction of the total stormwater volume, thereby reducing the annual pollutant loads that are discharged downstream.

Sedimentation removes pollutants attached to suspended particles as runoff percolates through the soil profile.

The hydrologic diversity and vegetative biodiversity of enhanced stormwater ponds increases the viability of the basins and their ability to optimize natural processes. Denitrification, where soil microbes convert excess nitrate or nitrite to inert nitrogen gas, may be enhanced in deeper sections of the ponds with anaerobic conditions, or in areas with subsurface saturated zones. Carbon sequestration can occur with greater plant growth and microbial activity. Soil amendments can also be used to enhance pollutant removal. Enhanced stormwater ponds can provide multiple wildlife habitats and serve as community focal points and recreational amenities. They have demonstrated effective water quality treatment and increased biodiversity for a wide range of plant and animal species.

UNIT PROCESSES

A combination of physical, chemical, and biological processes remove pollutants from the permanent pool. Infiltration, evaporation, and transpiration combine to reduce the influent volume.

EFFECTIVENESS

Enhanced stormwater ponds are designed to retain or detain stormwater with similar effectiveness at removing solids. However, they are generally more effective at removing dissolved nutrients than standard retention ponds.

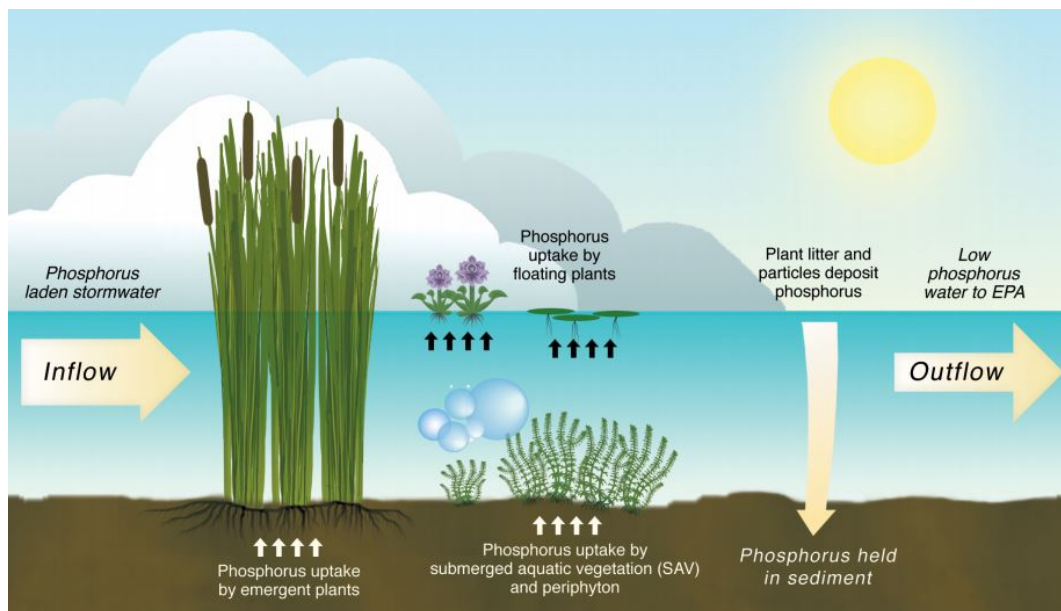

Figure 5-20. Phosphorous cycle in enhanced stormwater ponds.

DESIGN CRITERIA

There are many criteria for effective enhanced stormwater ponds:

- **Forebays** - For all types of stormwater ponds, shallow forebays are recommended for sedimentation as water enters the pond and to facilitate easy periodic sediment removal. They are typically sized to be about 10% of the treatment volume. Designs should dissipate the initial energy of inflows to avoid turbulence and resuspension of previously deposited sediment.
- **Side slopes** - Side slopes should be no steeper than a 3:1 ratio.
- **Depth** - Varying pond depths accommodate a wider range of plant species, and deep sections promote de-nitrification. Typical permanent pool depths average about 4 feet; maximum depth should not exceed 12 feet.
- **Flow paths** – Longer flow paths slow velocities and increase residence times.
- **Littoral zone** – Should extend from the top of the treatment volume to below the permanent pool elevation, with a slope not steeper than 6:1, planted with emergent and submerged aquatic vegetation. About 20% of the total surface area is recommended to be littoral zone.
- **Vegetation** – Careful selection of appropriate plants is important. They should be replaced if healthy growth does not occur within the expected establishment period. Invasive or exotic plants should not exceed 5% of the total vegetation. Accumulated vegetation should be harvested and removed from the area after approximately 50% of the open water surface is covered.

EXAMPLE

The Stormwater Treatment Areas (STAs) located south of Lake Okeechobee have used combinations of emergent and submerged wetland plants to successfully remove phosphorus from water entering the Everglades, reducing concentrations from 170 parts per billion (ppb) about 20 years ago to levels as low as 11 ppb in 2018.¹⁰³ While the STAs are considered constructed wetlands rather than enhanced stormwater ponds and are much larger than any urban stormwater treatment area, they also contain cells with varying depths and vegetation suited to each aquatic habitat. The pollutant removal processes provided by wetland plants are the same.

NEW DEVELOPMENTS/TRENDS

Optimizing the design of stormwater ponds to achieve greater nitrogen removal is an evolving area for research. The best method for achieving denitrification without the potential for associated increases in greenhouse gases (nitrous oxide and methane) is being investigated. Fluctuating between anaerobic and aerobic conditions or the creation of saturated soil zones, rather than fully saturated subsoil, appears to be beneficial.¹⁰⁴ The addition of soil amendments is another option to enhance stormwater treatment and target particular pollutants.

¹⁰³ South Florida Water Management District. (n.d.). *Water quality improvement*. Retrieved June 11, 2019, from <https://www.sfwmd.gov/our-work/wq-stas>

¹⁰⁴ McPhillips, L., & Walter, M. T. (2015). Hydrologic conditions drive denitrification and greenhouse gas emissions in stormwater detention basins. *Ecological Engineering*, 85, 67–75. <https://doi.org/10.1016/j.ecoleng.2015.10.018>

5.7.3. Floating wetlands

DESCRIPTION AND APPLICABILITY

Floating wetlands are more formally known as Managed Aquatic Plant Systems (MAPS). Aquatic plants attached to floating mats or other support material take up dissolved nutrients from the water, functioning like an extended littoral zone. Periodically, plant growth is harvested and removed from the pond for disposal. Various proprietary systems are available for supporting wetland vegetation.

BENEFITS

Dissolved nutrients are removed by vegetation through a low-cost, relatively low-maintenance method and are prevented from re-entering the system when plants die off and breakdown. They also create habitats for aquatic life, birds, turtles, and other wildlife.

UNIT PROCESSES

Biological removal by microorganisms in biofilms attached to vegetation and nutrient up-take by aquatic plants provides additional removal of dissolved nutrients beyond standard detention/retention ponds.

EFFECTIVENESS

The FDEP allows a 10% credit for both nitrogen and phosphorous reductions when floating wetlands are used as part of a BMAP with a 5% pool area coverage.

*DESIGN CRITERIA*¹⁰⁵

The design criteria include:

- **Area** – The floating mats typically make up at least 5% of the total surface area of a treatment pond.
- **Protect plant roots** – Netting may be used around roots to protect them from fish, turtles, or other animals that may feed on them.
- **Establishment of plants** – Within 6 months, plants should be well-established, covering about 90% or more of the surface, with no more than 10% being exotic or nuisance species.
- **Schedule maintenance** – An operation and maintenance plan should be provided to ensure adequate inspection and replacement of plants, if necessary. Vegetation is often harvested annually, but harvesting may be required more frequently depending on various factors.

¹⁰⁵ Escambia County. (2016). *Escambia County LID manual*.

EXAMPLE

Floating wetlands were installed in Tumblin Creek Stormwater Park in Gainesville, FL to remove nutrients. The photo shows healthy growth three months after installation (Figure 5-21). Plants such as pickerel weed, bulrush, and canna have performed well here.¹⁰⁶



Figure 5-21. Floating wetlands in Tumblin Creek Stormwater Park.
(Photo: K. Songer)

5.8. Other Treatment Systems

5.8.1. Onsite wastewater treatment options

DESCRIPTION AND APPLICABILITY

Onsite sewage treatment and disposal systems (OSTDS), more commonly known as septic systems, provide primary treatment in tanks. This effluent discharges into drainfields, which rely on filtration and microbial action in unsaturated soils to treat the remaining nutrients and bacteria. Design criteria mandated by Chapter 64E-6, Florida Administrative Code and administered by the Florida Department of Health, call for a minimum of two feet between the bottom of a drainfield and the seasonal high-groundwater level (SHGL). However, before 1972, Florida regulations required only 12 inches for treatment zone above the SHGL. Minimum lot sizes allowed for septic systems are currently 0.5 acre per dwelling unit, but again, neighborhoods that were platted before 1972 may have homes that do not meet this standard.

Conventional types of onsite treatment systems include:

- **Standard** – uses gravity flow and the top of the drainfield aggregate has at least six inches of soil cover.
- **Filled system** – the drain pipes are placed at or slightly above the natural ground, and the drainfield aggregate is partly above and partly below the level of the undisturbed native soil.

¹⁰⁶ ACF Environmental. (2010, April 27). *TMDL credits, TMDL reductions are possible with floating wetlands - managed aquatic plant systems - Florida and the Eastern US*. Retrieved from <http://floatingwetlands.blogspot.com/2010/04/tmdl-credits-tmdl-reductions-are.html>

- **Mound systems** – the complete drainfield is raised above the level of the undisturbed ground.
- **Dosing systems** – wastewater is pumped from the tank into the drainfield.

Filled or mound systems are used where the soil below the drainfield is too shallow above the water table or a confining layer. The soil in these systems can more easily be amended to improve treatment.

Low pressure dosing pumps are required for filled and mound systems where gravity flow is not possible, but it may also be chosen for its other benefits. Pressure dosing provides more even distribution throughout the drainfield and the soil is able to infiltrate more effectively with pauses between the dosing cycles. These systems have fewer problems with clogging than gravity flow drainfields.

Alternative onsite treatment systems include:¹⁰⁷

- Advanced aerobic (secondary) treatment units (ATUs) with drip irrigation disposal, which are a performance standard for onsite wastewater treatment units and may be paired with simple drip irrigation systems rather than underground drainfields.
- In-ground nitrogen-reducing biofilters (INRB).

Standard septic tanks may be replaced with any unit capable of treating wastewater to secondary treatment standards or better for CBOD5 and TSS. Drip irrigation through perforated hoses may then be used for effluent disposal. There are several types of systems that can meet this standard, including the passive nitrogen reduction systems (PNRS) described below under “New developments.”

In-ground nitrogen-reducing biofilters use standard septic tanks but achieve higher levels of nitrogen removal by passing effluent through two layers: an 18-inch deep sand fill layer and a 12-inch deep media layer. The bottom of the media layer must be at least 6 inches above the SHWT. A [list of products](#) meeting these requirements is available from the Florida Department of Health.

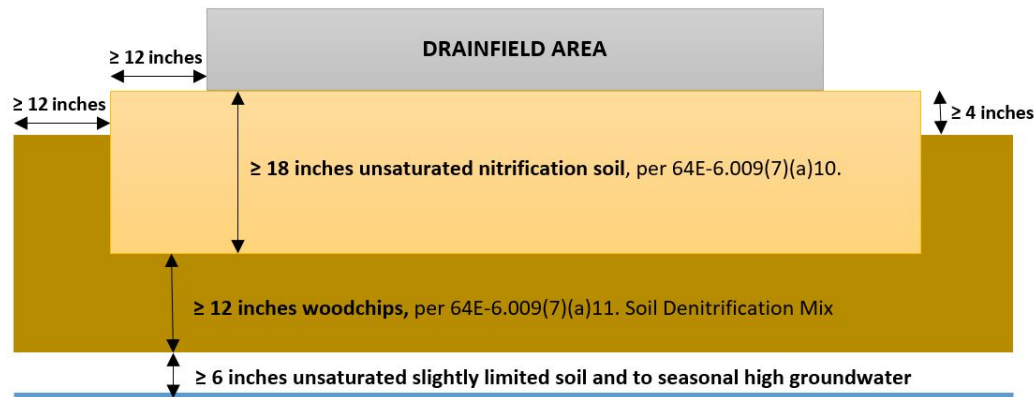

Figure 5-22. Schematic of an in-ground nitrogen-reducing biofilter. (Graphic: Florida Department of Health)

¹⁰⁷ Florida Department of Health. (2018, July 11). Proposed changes to Chapter 64E-6, Florida Administrative Code, 64E-6.009 alternative systems and 64E-6.012 standards for the construction, operation and maintenance of aerobic treatment units. Retrieved from www.floridahealth.gov/environmental-health/onsite-sewage/documents/64e-6-009-012-adopt-eff-07-31-18.pdf

EFFECT OF SEA LEVEL RISE ON ONSITE TREATMENT AND DISPOSAL SYSTEMS (OSTDS)

In Miami, mean sea level has risen about four inches since 1994 and is expected to rise six to ten inches above 1992 levels by 2030. Under current conditions, the rate of rise is expected to increase, adding 10 to 26 inches more by 2060.¹⁰⁸ In some areas, existing systems are already being compromised for at least part of the year, and additional septic systems in the region will be adversely impacted by sea level rise. Occupants of buildings using these systems are likely to be unaware of the systems' hydraulic failure unless groundwater intersects the ground surface nearby. Wastewater will not backup into buildings unless flooding occurs, but inadequately treated wastewater may still flow into the groundwater undetected. Pathogens as well as nitrates and ammonia may degrade water quality in groundwater and some surface waters. Some older septic systems allowed under the previous standard, where SHGL is already less than two feet, will be more vulnerable to hydraulic failure from sea level rise.

There are several options to prevent or mitigate hydraulic failures of OSTDS. Modifying conventional drainfields into filled or mounded systems is probably the least disruptive and least costly alternative, but that option may have a limited life depending on the local conditions and the extent of sea level rise. Secondary wastewater treatment units or in-ground nitrogen-reducing biofilters are new options that should be considered. Their costs may be somewhat higher than raised or mounded systems, but they are capable of higher levels of nitrogen removal.

Septic to sewer conversion projects connect homes to a central wastewater treatment and abandon the onsite systems. Low pressure or vacuum sewer lines may be used instead of gravity sewer pipes. These use much smaller diameter pipes and can be installed in shallow trenches, irrespective of ground elevation. Decentralized package wastewater treatment plants may be an option for barrier islands or clusters of homes that are not easily connected to larger existing treatment plants.

BENEFITS

There are many benefits for various solutions.

- **OSTDS** – In areas with low population densities and suitable soil and groundwater conditions, OSTDS provide adequate reductions in nitrogen and pathogens from domestic and most commercial wastewater. Standard onsite systems also provide the least expensive option for wastewater treatment. Alternative onsite systems increase costs, but they are likely to be much less expensive than retrofitting sewers and connecting to a central wastewater treatment plant. In 2015, a new standard tank and drainfield was estimated to cost about \$3,000, while the average cost for an advanced PNRS system was estimated to be \$13,700 (new) or \$16,500 (retrofit).¹⁰⁹ Connecting to a sewer requires individual residents to pay connection costs, with other costs borne by all customers.
- **Septic to sewer conversions** - If onsite septic systems are connected to sewers with central wastewater disposal, in suitable locations, homeowners and local governments have an option to convert the disconnected septic tanks to stormwater cisterns for infiltration. Typical septic tanks hold a significant volume (900 to 1500 gallons), roughly equivalent to 50–75 rain barrels per site. Infiltrating fresh stormwater into the soil may help counter local saltwater intrusion.

¹⁰⁸ Southeast Florida Regional Climate Change Compact Sea Level Rise Work Group (Compact) (2015). *Unified sea level rise projection for southeast Florida*. Retrieved from <http://www.southeastfloridaclimatecompact.org/wp-content/uploads/2015/10/2015-Compact-Unified-Sea-Level-Rise-Projection.pdf>

¹⁰⁹ Southeast Florida Regional Climate Change Compact. (2015). *Unified sea level rise projection*.

Increases in residential density through redevelopment may be a consequence of septic to sewer conversion programs, as large lot sizes are no longer required for safe disposal of wastewater. Whether this is desirable or not will depend on the individual circumstances of each location and municipality.

UNIT PROCESSES

Unsaturated soils surrounding drainfields reduce N loads through sorption and nitrification in varying degrees. Denitrification in Florida's well-drained sandy soil is usually minimal.

EFFECTIVENESS

Standard, well-functioning OSTDS generally provide about 30% to 40% N removal and are considered effective at reducing pathogens. If less than 24 inches of soil depth above SHGL is available, their efficiency is reduced and the risk of pathogens entering groundwater is increased.

DESIGN CRITERIA

The Florida Department of Health [Chapter 64E-6, Florida Administrative Code](#) specifies design criteria for OSTDS. [Changes to Chapter 64E-6](#) (July 2018) to incorporate nitrogen-reducing in-ground biofilters and aerobic treatment unit technology contain details of design criteria for these systems.

EXAMPLE

The Loxahatchee River Environmental Control District (LRECD) is a wastewater utility in northeast Palm Beach County and southeast Martin County that has had a septic to sewer conversion program since 1981 to reduce pollution in the Loxahatchee River and surrounding habitats. They rank remaining neighborhoods based on criteria such as the suitability of the soils and water table, the flood risk, as well as their proximity to existing infrastructure, costs, and other criteria. They use a mix of gravity and low-pressure systems in the converted neighborhoods.

The LRD operates an environmental education center focused on water quality in the Loxahatchee River, and they partner with other organizations to carry out a community-based oyster restoration program in the Loxahatchee River estuary.

NEW DEVELOPMENTS/TRENDS

New technologies for passive nitrogen reduction systems (PNRS) for onsite wastewater treatment and disposal were developed and tested under a contract with the Florida Department of Health, along with simple computer tools to model the fate and transport of nitrogen from these systems.¹¹⁰ The designation "passive" indicates that the systems require no mechanical parts other than a single pump. The designs incorporate primary treatment followed by a two-stage biofiltration process. The first stage of biofiltration uses unsaturated gravity flow for nitrification, while the second stage pumps wastewater upward through a saturated media for denitrification.

Two-year-long field tests indicated that the systems removed 90% to 95% of nitrogen, with a N effluent concentration under 5 mg/l before the effluent flowed to a drainfield for disposal. Pathogens were not measured in that study.

5.8.2. Living shorelines

As with many BMPs, a "living shoreline" may be called alternative names, such as "bioengineered shoreline," "productive shoreline," or just "vegetated shoreline." Replacing hard seawalls, groins,

¹¹⁰ Southeast Florida Regional Climate Change Compact. (2015). *Unified sea level rise projection*.

breakwaters, and other structures, they incorporate combinations of shoreline erosion protection (rock and/or sand-filled structures) with materials to recreate a natural shoreline, including mangroves, sea grasses, and oyster beds.

BENEFITS

Living shorelines trap sediment and absorb wave energy and storm surges, stabilizing them and reducing erosion and impacts to coastal infrastructure. They often re-establish aquatic habitats where plant life and shellfish purify water and increase dissolved oxygen levels in estuaries. Restoration of natural habitats are crucial for shelter and support for many species of fish and other aquatic life, improving biodiversity. Algae growth may be reduced and water clarified. Public use of the estuary and shoreline are often enhanced. Existing coastal development benefits from heightened storm protection.

The greatest negative aspect of living shorelines is their high cost. Individual projects have been estimated to cost between \$50,000 and \$200,000. In addition, some property owners may object to changes along the shoreline, particularly to mangroves that have been thought to ruin the view and attract insects.¹¹¹

UNIT PROCESSES

Sedimentation and filtration remove particulate matter and pollutants adhered to them. Dissolved nutrients are removed by biological uptake.

EFFECTIVENESS

It is difficult to determine the effectiveness for living shorelines, as their design and purposes are so varied and many years may be necessary for their benefits to fully accrue.

However, some living shoreline projects in Florida have been in place for more than a decade and have successfully attracted birds, fish and have allowed flourishing oyster beds and sea grasses to grow (Figure 5-23). A study comparing the health and productivity of natural and artificial oyster reefs in Lake Worth Lagoon 2008-2010 found that all were healthy, productive systems and anticipated that future restoration projects, “should not only be successful, but would improve water quality, provide



Figure 5-23. John's Island oyster reef restoration 2009-2013.

erosion control and increase habitat for associated species such as other invertebrates, fish, and birds.”¹¹² Other locations, such as the Chesapeake Bay, have improved water quality over time, credited in part to living shorelines.

¹¹¹ Southeast Florida Coral Reef Initiative. (2013). *Recommended Management Actions N-116: Implement Regional “Living Shorelines”* (No. OFR RMA N-116). Retrieved from <http://ourfloridareefs.org/land-based-sources-of-pollution/>

¹¹² Scarpa, J., & Laramore, S. E. (2010). *Survey of select eastern oyster (Crassostrea virginica) populations in Lake*

Neither the FDEP nor the SFWMD have established criteria for crediting pollutant removal with living shorelines due to a lack of data.

DESIGN CRITERIA

Florida also has no state design criteria for living shoreline projects, but permits are required from the U.S. Army Corps of Engineers to make shoreline alterations other than planting vegetation on existing shorelines without additional fill material. An ERP Permit must also be issued by SFWMD or FDEP for living shoreline and restoration projects.

Many resources are available to guide designs. A [list of online resources](#) compiled by the Living Shorelines Academy includes several from the Florida Department of Environmental Protection and Florida Sea Grant, as well as from other governmental and scientific or conservation organizations nationwide. The American Society of Civil Engineers' Coastal Zone Management technical committee works to establish design fundamentals based on research and case studies of existing living shorelines.

Site-specific designs reflect the priorities for water quality, habitat restoration, and erosion prevention at each location. After defining the physical and ecological goals, sites should be evaluated for basic existing conditions:

- The type of water body: inland non-tidal, estuary, open shoreline
- The condition of any existing shoreline protection and whether to retain, modify or remove it
- The presence and types of existing vegetation
- The degree and causes of erosion
- Slope of shoreline and nearshore water depth
- Expected tidal range and sea level rise
- Degree of exposure to boat wakes and waves
- Salinity and current water quality
- Static or dynamic new construction
- Potential wildlife habitats
- Potential for public access, forms of use and amenities to be provided

For shoreline stabilization projects, the level of protection that may be provided by a particular design should be determined and plans made to minimize damage from overtopping by waves or storm surges.

Worth Lagoon, Palm Beach County, Florida 2010 Annual Report (No. Project #2008-0404) (p. 58). Palm Beach County: Harbor Branch Oceanographic Institute at Florida Atlantic University Aquaculture and Stock Enhancement Program. Retrieved from <http://discover.pbcgov.org/erm/Publications/OysterSurvey.pdf>

EXAMPLE

Lake Worth Lagoon is approximately 20 miles long by ½ mile wide and receives stormwater from a heavily urban watershed of about 450 square miles. Beginning in the early 1990s, a series of restoration projects have been undertaken to improve water quality. The large number of projects to establish artificial islands, reefs, seagrasses, and associated projects developed in Lake Worth Lagoon over more than 20 years have had a positive effect on water quality and local businesses. Fishing, paddle-boarding, and kayaking are part of a growing eco-tourism industry in Palm Beach County in response to improved water quality and aquatic habitats.¹¹³



Figure 5-24. Before and after photos of Palm Beach Par Three Mangrove Planter.

¹¹³ Meszaros. (2015, February 5). *Lake Worth Lagoon's ecotourism increases.*

6. ASSESS APPLICABILITY OF CANDIDATE SCMS

Previous chapters in this manual have provided information most suitable for the early phases of planning and evaluating potential strategies to address LBSP through an LID/GI lens. Collectively, however, the SCMs introduced in Chapter 5 are not directly transferrable and fully effective without being carefully selected and tailored to meet the unique characteristics of a given site or project. The next sections of this manual move from planning and identification of site opportunities and constraints into fundamental design considerations and guidelines that can be used to assess the applicability of candidate SCMs at a specific site. Chapter 6 is structured to address the following questions pertinent to appropriate LID/GI SCM selection as well as complementary design considerations to ensure efficacy and effective performance of the SCMs in practice:

1. *How do physical, socio-economic, and legal design and implementation factors constrain the feasibility and potential effectiveness of each SCM on its own and as part of a treatment train?*
2. *Once the most appropriate LID/GI SCMs have been selected for a site, how can they be put together in a treatment train design that, in practice, maximizes their collective potential for reducing, assimilating, and mitigating LBSP? Are there real examples that demonstrate success of this integrated SCM approach?*
3. *How do construction standards and considerations for LID/GI projects with a suite of integrated SCMs differ from those applicable to conventional stormwater management design?*

Key take-home messages include:

- The LID/GI treatment train concept represents a fundamental shift of SCM approaches from centralized, concentrated, large-scale downstream treatment measures to distributed, down-scaled, and integrated source control, storage, infiltration, conveyance, and treatment measures applied across physical space and hydrologic timescales.
- LID/GI emphasizes careful identification, protection, and limited disturbance of site assets—mimicking ecosystem and hydrologic function as it existed pre-development to reduce the number and scale of treatment measures necessary to achieve water quality and volume control goals.
- In general, the costs of integrating LID/GI SCMs with retrofit or redevelopment projects are greater than those for new development, although this holds for most design considerations, not only those affecting LBSP and stormwater management.
- Potential physical constraints that merit careful consideration and evaluation on any LID/GI project include space/land area, elevation/site topography, soils/water table, existing infrastructure, and vegetation compatibility with the SCM and site land use.
- Even projects with ideal site conditions and limited physical or technical constraints, social, and legal issues are likely to affect the feasibility of implementing LID/GI SCMs. These range from arbitrary or outdated requirements in comprehensive plans to unclear legal boundaries for properties, and different land uses to public perceptions of health and safety risks associated with SCMs that do not align with actual risk.
- Despite the range of factors likely to constrain SCM selection (some of which can be overcome and others of which are intractable), LID/GI design criteria and guidelines along with growing numbers of demonstration projects can serve as models for Southeast Florida.

6.1. Identifying Design & Implementation Constraints

6.1.1. Physical constraints

With SCMs, there is no one-size-fits-all solution. Each site has its own characteristics and goals for managing stormwater control measures. This chapter covers various constraining factors that can limit SCMs applicability for sites.

Several factors will determine the applicability of candidate SCMs for installation, whether new development or retrofit. These factors will ultimately constrain the size and function of SCMs, potentially limiting their feasibility. The orientation of runoff-producing areas and receiving SCMs will be largely dictated by what a site offers and the ability or resources to modify the constraints. These constraints need to be accounted for before the design process begins. In some cases, the site constraints may offer a fairly obvious solution, while in other cases several options may appear feasible and require more detailed evaluation.

New construction and development will have greater flexibility to incorporate stormwater management into the site compared to retrofits and redevelopment projects. Retrofits or redevelopment projects are more likely to have more restrictive constraints, which often causes those projects that incorporate greater stormwater management to have higher costs compared to new construction for treating the same runoff volume.

AVAILABLE SPACE

Each SCM will require some minimum area to treat runoff. Depending on the treatment processes, functions of the SCM, and characteristics of the site, areas and volumes will need to be allocated. For this reason, stormwater design should be integrated throughout the design process, from concept through to completion.

For sites having high property values, where space comes at a premium cost, some SCMs are better than others at being integrated into developments. Permeable pavements and underground exfiltration can manage runoff without requiring a dedicated area or sacrificing the utility of the area at the surface (e.g., parking or drive paths).

Always consider the tradeoffs between reducing impervious areas and the area required for treating runoff. Increasing runoff source areas will typically increase the treatment area or volume proportionally or sacrifice treatment efficiency by decreasing residence time and increasing maintenance frequency.

ELEVATION

Without incorporating active pumping systems, managing runoff relies on water's natural gravity flow to lower elevations, therefore requiring an appropriate drop in elevation to facilitate the water flow. Consider that runoff from a rooftop could be captured by an above ground cistern, but another SCM would be needed address runoff from pavement surfaces at the ground level. Overflow from the cistern could be directed to the same SCM treating the pavement runoff.

Site grading and infrastructure can be designed to direct runoff to SCMs. Distributing the treatment of runoff to be as close to the sources as possible can limit the cost of piping needed for conveyance on the site. However, distributing SCMs around the site requires that areas be allocated early in the site design process.

SOILS AND WATER TABLE

Restrictive soils, such as those high in clay content, and high water table conditions will limit the feasibility of infiltration practices. Each of these will limit the vertical infiltration rate available for SCMs to recover their volume between runoff events. Nearly all infiltration practices will require at least two feet of separation from the seasonal high water table. Most infiltrating SCM designs can be modified to include underdrains and eliminate or not rely solely on infiltration, although likely substantially affecting function and treatment performance.

EXISTING INFRASTRUCTURE

The location and elevation of existing infrastructure can significantly restrict SCM placement. While relocating utilities is an option, it usually comes with a significant cost increase to the project. Before determining the location for an SCM, the location of all existing and proposed utilities should be determined. In addition, the full depth of proposed SCMs should be accounted for to avoid utility conflicts. Even for utilities with sufficient vertical separation from the bottom of SCMs, caution should be used when siting SCMs over existing or proposed infrastructure. In the case of required utility maintenance, an overlying SCM may be disturbed, potentially affecting the system function.

Particularly with retrofits and redevelopment projects, the elevation of stormwater inlets, pipes, and junctions will typically constrain the elevation of SCM inlets and outlets. While SCMs may be modified to meet these constraints, the performance may be greatly affected.

VEGETATION COMPATIBILITY

Selecting appropriate vegetation for certain SCMs (e.g., bioretention) is central to their treatment processes. It is important that vegetation be tolerant of the conditions, which can vary across zones within an SCM. In addition, the function, aesthetics, and maintenance should also be considered. Vegetation diversity can also provide resilience to extremely dry or wet conditions. Plants that are resilient to the extremes of SCM conditions make strong candidates. Native vegetation is almost always recommended over exotic plants.

6.1.2. Social and legal constraints

MUNICIPAL AND ZONING PREREQUISITES

The long institutional history of permitting “conventional” stormwater systems creates legal, regulatory, permitting, and enforcement barriers that cannot be overcome quickly, which makes it difficult to implement non-conventional solutions when the buy-in and commitment is skewed toward the status quo. An additional challenge is that the scarcity, limited scale, and/or nascent nature of the LID/GI projects that have been constructed in Southeast Florida inherently constrains the ability to collect empirical data that might validate expectations based on modeled performance. Many LID/GI projects are not seriously evaluated for applicability, let alone are allowed to move forward, until well-intended yet often contradictory legal constraints are identified and removed from comprehensive plans, land development regulations, local ordinances, and HOA covenants, conditions, and restrictions.

PROPERTY OWNERSHIP

There are also challenges with respect to property ownership, public/private space boundaries, and clear legal responsibilities for management and care of water resources along the watershed transect (e.g., upstream polluters are not required to address water quality problems and property value losses downstream). In many cases, enforcement mechanisms do not hold the polluter accountable for costs

outside of their proprietary domain. Once stormwater flows offsite, it is often out of sight and out of mind, giving property owners an incentive to convey stormwater off their property as soon as possible.

HOMEOWNERS ASSOCIATION (HOA) COVENANTS AND RESTRICTIONS

Homeowners associations can have significant impacts on stormwater quality discharged from residential areas. They may unwittingly increase nutrient loads by requiring a particular type of landscape in their covenants that residents must maintain with frequent application of fertilizer, herbicides, and pesticides. Conversely, they can play a positive role in promoting Florida-Friendly Landscaping™ and encouraging water-conservation.

Stormwater ponds and other SCMs are often located on communal property managed and maintained by an HOA. The exact line of responsibility for maintenance can vary with differing perceptions of where the responsibility for abiding by HOA documents lies in the physical space. Is the boundary the water line or the edge of a riparian zone? Homeowner's associations may also contract for maintenance of vegetated swales and rain gardens located in stormwater easements on private property.

HUMAN HEALTH AND SAFETY

Even with so-called perfect information, public perception of risk seldom aligns with reality. Part of this is the nature of different planning horizons (e.g., 30-yr. comprehensive planning vs. daily, monthly, or annual planning horizons from a homeowner perspective or build-out horizons from a developer perspective). To mitigate LBSP through LID/GI projects, the lack of a common perspective suggests that aggressive public education campaigns are needed to raise awareness of the scope and magnitude of costs associated with water pollution and downstream damages to vital natural resources and ecosystems. Another aspect is the need to better understand the ecosystem services and benefits that coral reef ecosystems, clean water, a stable climate, and more provide for the public good.

Homeowners often perceive standing water (e.g., with distributed retention basins rather than one large central basin) as breeding grounds for mosquitos, snakes, or other health and safety hazards. Additionally, the costs of converting from septic to sewer are perceived as being born upfront only by the individual and well beyond the value received from moving to a less polluting system for the public good.

6.2. Moving from Design to Practice: Putting the pieces together

The array of possible choices for stormwater control and treatment can be confusing, and the decision of which to use must consider multiple factors. However, the density and type of development can narrow the likely candidates. Suitable stormwater control measures can be organized by urban transects (Figure 6-1). Transects are simply a short-hand method of characterizing different types of development and are used by urban planners as a basis of form-based zoning codes. Some type of bio-retention can be used in all transects, but vegetated swales and rain gardens suitable in lower density areas are replaced by street trees, infiltration planters, and parking lot islands in more urban transects. Cisterns for rainwater harvesting can be adapted for use at all densities.



Figure 6-1. Rural to urban transects and suitable LID SCMs. (Graphic by Duany Plater-Zyberk & Company)

The process of choosing the most appropriate SCMs for a site can be organized into a decision tree (Figure 6-2).¹¹⁴ Starting with defining the problem and setting objectives and goals, the site is then characterized, and the necessary unit processes are considered. A list of possible options is made, which is narrowed by site constraints and other limitations to settle on the most appropriate SCM for a specific application.

A conceptual design process should include the following steps:

1. Identify the problem, i.e. characterize the site, expected pollutants and treatment levels;
2. Identify the unit processes needed for removal;
3. Select a range of SCMs capable of providing treatment;
4. Apply site constraints and eliminate or rank the remaining SCMs;
5. Size the selected SCMs and develop a conceptual design; and
6. Prepare a performance monitoring and evaluation plan.¹¹⁵

¹¹⁴ Huber et al. (2005). *Evaluation of best management practices*.

¹¹⁵ Huber et al. (2005). *Evaluation of best management practices*.

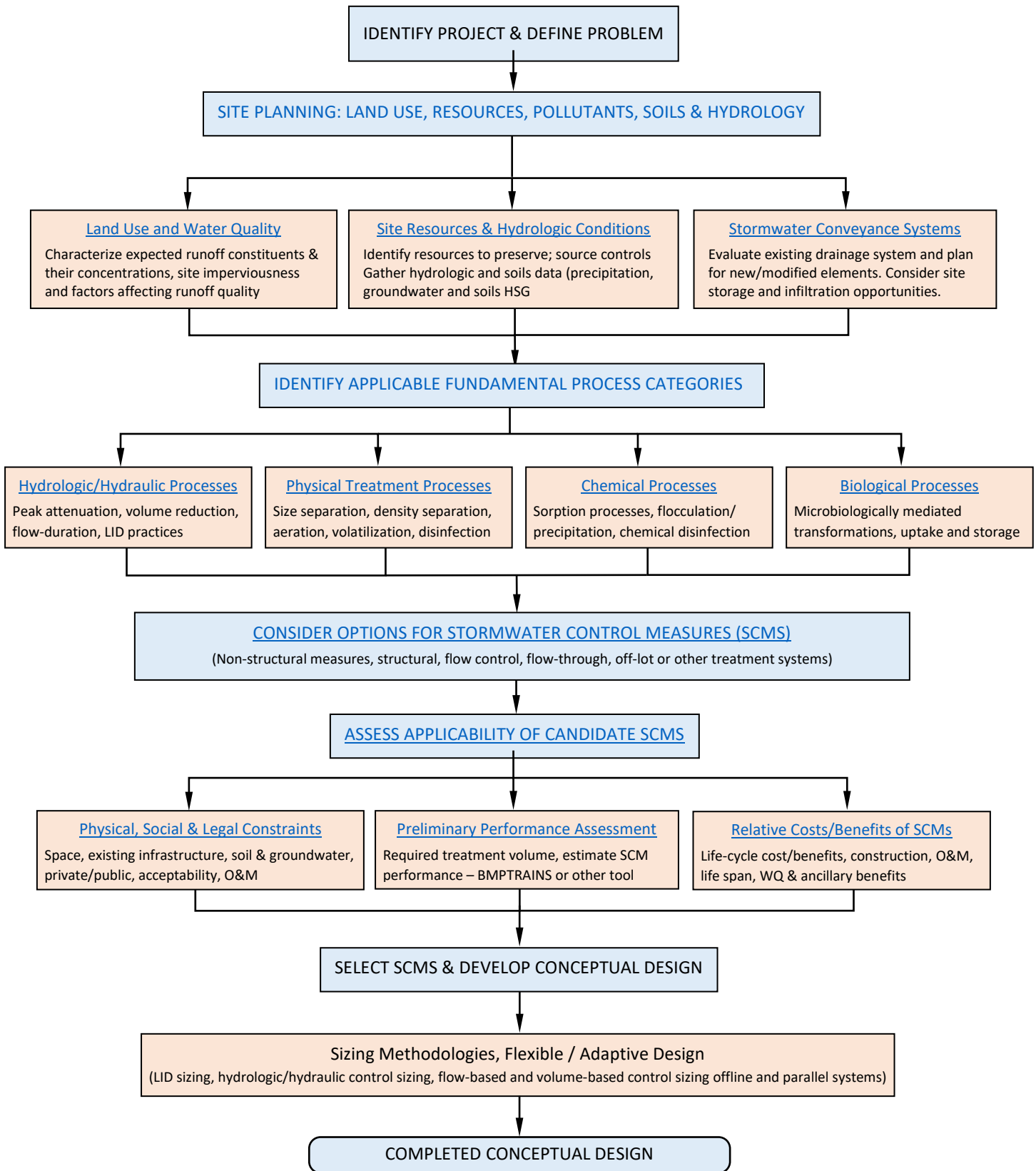

Figure 6-2. Conceptual stormwater treatment system design methodology flow chart. [Adapted from Huber et al. (2005). Evaluation of best management practices.]

6.2.1. Green streets/complete streets/smart growth

The EPA defines a [green street](#) as “a stormwater management approach that incorporates vegetation (perennials, shrubs, trees), soil, and engineered systems (e.g., permeable pavements) to slow, filter, and cleanse stormwater runoff from impervious surfaces (e.g., streets, sidewalks).” Green streets therefore incorporate multiple LID BMPs to provide source control, and a wide range of treatment mechanisms, as well as expanding green spaces along urban streets. A similar but more expansive concept is that of “[complete streets](#).” This term was coined in 2003 by America Bikes to promote safe street access for cyclists, pedestrians, public transit riders, and motorists. It has been adopted by city planners who have expanded its use to include all aspects of streetscapes. Although stormwater may not be a specific focus in complete street documents, in practice, they often include GI elements such as narrow pavement lanes, permeable pavement and bioretention in median islands, curb extensions, infiltration planters, and tree boxes.

Nationwide, cities have increasingly adopted green or complete street designs, and some have successfully rehabbed existing streets to solve flooding and combined sewer overflow problems. While Southeast Florida has unique flooding problems, reducing stormwater runoff volume through LID measures offers a partial solution. Many municipalities in Southeast Florida have adopted policies to encourage green or complete streets, including Broward, Miami-Dade, and Martin Counties.

In one example of this in Southwest Florida, the [Bonita Springs Downtown Improvements Project](#) used several LID features as part of a broader redevelopment plan. Street travel lanes were narrowed to 11 feet, pervious pavers were installed for on-street parking, landscaped islands and a landscaped median were installed, and wider sidewalks and other improvements were implemented.

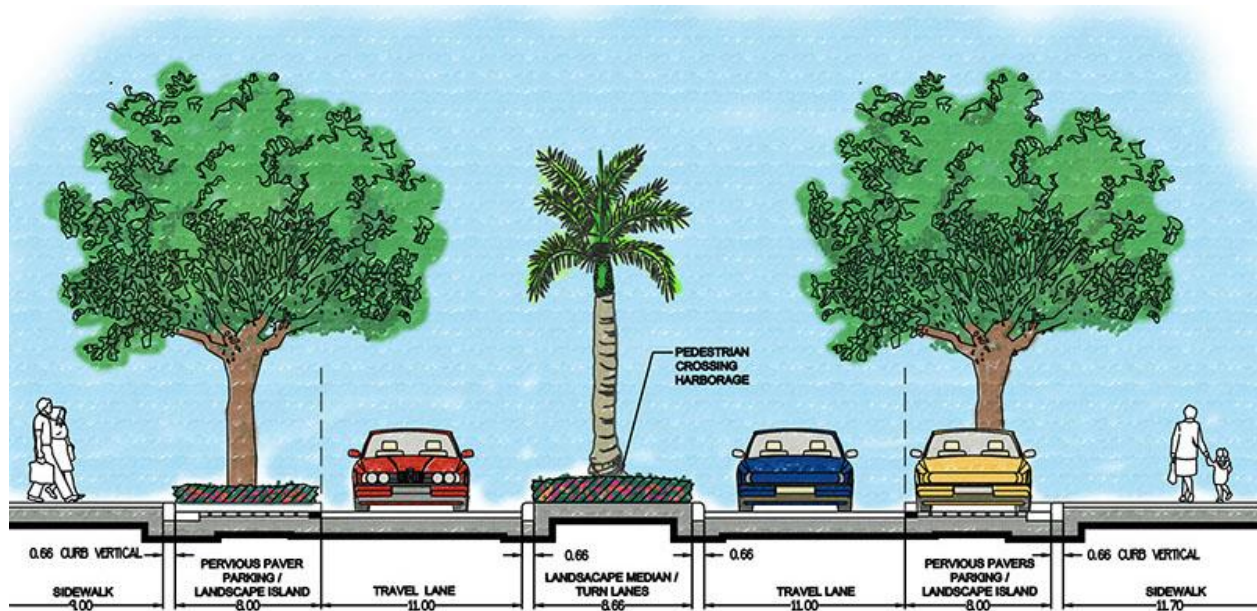

Figure 6-3. Street cross-section, Bonita Springs Downtown Improvements Project

Beyond streets, other public and private urban areas are being retrofit to become more inviting and less polluting. The term “[smart growth](#)” recognizes similar principles applied to broader urban and regional development. Again, without focusing particularly on stormwater, smart growth aims to reduce sprawl by

encouraging compact building designs and the preservation of open space and environmental resources (reducing impermeable areas, stormwater runoff volumes, and pollutant loads).

At Bayhead Park in Pinellas County, two “sterile” detention ponds were retrofitted into bio-retention pond amenities. Native plant littoral zones were created, and hundreds of trees were planted in upland and shoreline areas, integrating them into recreation areas with a loop trail and educational signage. Some stormwater is harvested from the ponds for irrigation water within the park, and another portion is infiltrated onsite. The relatively high nutrient levels in harvested stormwater reduced the amount of fertilizer needed on the landscape.¹¹⁶

Green street projects can be small, starting with redevelopment on individual properties, or they can be scaled up to ambitious city-wide programs. For example, Chicago began installing permeable pavement in alleys in 1989 along with many other LID measures. By 2010, they had more than 2,500,000 square feet of green roofs, 583,000 new street trees, and more than 73 linear miles of bioretention medians in the city. In Portland, Oregon, downspouts were disconnected on more than 50,000 homes between 1994 and 2010, estimated to have reduced runoff by about 1.2 billion gallons.¹¹⁷

6.2.2. Treatment train design examples

Although there are many possible combinations of SCMs, the following are some examples that could be used in many places. Where infiltration is feasible, SCMs using retention as a primary treatment should be chosen to take advantage of their ability to treat and dispose of stormwater in the soil. If infiltration is not possible due to soil or groundwater conditions, many of the same SCMs can be adapted for detention with underdrain collection and treatment provided by appropriate media—often soil amendment or filtration processes.

- **Low density residential** – disconnect downspouts, raingarden, vegetated swales, wet retention pond, advanced onsite wastewater treatment and disposal
- **Medium density residential** – rainwater harvesting (cisterns), raingarden with soil amendment, baffle box, offline retention, septic to sewer conversion
- **High density residential and mixed use** – street sweeping, permeable pavement, infiltration trenches, curb cuts, street tree/planter boxes, enhanced stormwater pond (use as a public amenity)
- **Large commercial and public buildings** – rainwater harvesting (cisterns), parking lot island bioretention, permeable pavement, inlet catch basins
- **Industrial** – filtration or nutrient separating baffle box, offline retention

The design of SCMs in treatment trains must always consider the effect of any preceding SCM when calculating influent conditions to a second or further downstream SCM. The efficiency of subsequent

¹¹⁶ Applied Sciences Consulting, Inc. (n.d.). Largo park transformation to feature stormwater recycling, recreational amenities. Retrieved February 26, 2019, from <https://appliedfl.com/projects/largo-park-transformation-to-feature-stormwater-recycling-recreational-amenities/>

¹¹⁷ EPA Office of Wetlands, Oceans and Watersheds. (2010). *Green infrastructure case studies: municipal policies for managing stormwater with green infrastructure* (No. EPA-841-F-10-004). Retrieved from <http://www2.ku.edu/~kutc/pdffiles/Green%20Infrastructure%20Case%20Studies.pdf>

measures will be reduced by the efficiency of previous SCMs if they employ the same processes. For example, sedimentation and retention that occurs in vegetated swales will reduce the load and percent removal efficiency in a wet retention pond. Of course, each contributing area must be considered separately; raingardens on residential properties will reduce the volume of stormwater and pollutant loads to a swale or piped system, but they will not affect the water volume or concentration of pollutants carried downstream from roadways contributing to the same downstream pond.

Detailed examples of design procedures for single SCMs or treatment trains can be found in several Florida manuals, such as the [Escambia County LID Manual](#), [Pinellas County Stormwater Manual](#), and [Sarasota County Low Impact Development Guidance Document](#).

The [2010 Draft Environmental Resource Permit Stormwater Quality Applicant's Handbook](#) also has many detailed design examples and the necessary tables for parameters specific to Southeast Florida.

6.3. Construction Standards and Considerations

6.3.1. Site preparation

The construction activities on a greenfield site can have a major impact on the amount and quality of its future stormwater runoff. Non-structural design features must be protected during construction, whether they are existing vegetation, existing grading, or flow paths and soils that will not be covered by impervious surfaces. Such areas must be clearly delineated on plans and on the ground, and crews must understand the purpose for protecting specific portions of the site.

RETAIN VEGETATION

Avoid clear cutting and clearly mark designated vegetation to remain as well as areas where heavy construction equipment is prohibited. This requires consideration of staging and storage areas onsite and most importantly, communication to construction personnel on both the restrictions and the reasons for them.

PROTECT SOILS

To the extent possible, topsoil should be retained in place on future vegetated areas, not scraped and replaced. The common practice of building residences slab-on-grade on a platform of sand that extends well beyond the building footprint should be reconsidered. That practice results in landscaping planted in soil that cannot provide the nutrients or the moisture holding ability needed by the plants, requiring years of fertilization and irrigation by the property owner. Mulching and inexpensive soil amendments may be used, but amendments should adjust the pH of fill material to match the native soil to avoid excessive phosphorous leaching.



Figure 6-4. Typical construction fill can dramatically increase leachable phosphorus and raise pH levels, which also increases the solubility of many metals. (Photo: UF PREC)

6.3.2. Structural SCMs

GENERAL CONSTRUCTION CRITERIA

During construction, every effort should be made to limit compaction or siltation of infiltrating surfaces or media that are part of SCMs. Any deposits must be removed, and soil compaction must be avoided in areas that will function by infiltration.

- **Verify design criteria onsite** – The location and dimensions of all SCMs must be verified onsite prior to their construction. Other design requirements, including dimensions and distances to foundations and the locations of existing and proposed utilities, septic systems, and wells must also be verified.
- **Prevent soil compaction in retention areas** – The location of retention SCMs must be clearly marked at the site to prevent unnecessary soil compaction from vehicular traffic or otherwise across the area.
- **Excavation equipment** – Excavation must be done by lightweight equipment to minimize soil compaction. Tracked, cleated equipment causes less soil compaction than equipment with tires.
- **Site NPDES BMPs** – During construction, all BMPs requirements of the appropriate [NPDES permit instructions](#) must be met, such as those governing pollution prevention, erosion and sediment control, and soils stabilization.

6.3.3. Additional construction considerations for SCMs

SOIL AMENDMENTS

The versatility of soil amendments and the wide range of SCMs in which they are used mean that instructions for their use will differ somewhat by type and application. For all uses, the pH of the amendment (or of the soil mixture) should be considered. Increasing the soil's pH will affect the

availability of nutrients for plants and the soil's adsorption or release of metals, such as lead, zinc, cadmium, and manganese. Therefore, the soil's final pH must be carefully considered.¹¹⁸

- **Amendment characteristics** – must be matched to their intended function to remove targeted pollutants.
- **Increase infiltration capacity and restore a compacted natural soil** – an analysis is needed to determine the appropriate pH, porosity, and nitrogen content.
- **Avoid compaction** – amended soil must be carefully placed, and heavy equipment must be kept off of the area.

GREEN ROOF/CISTERN STORMWATER TREATMENT SYSTEM

The construction of a green roof must comply with instructions provided for any proprietary systems/equipment. Additional considerations¹¹⁹ include:

- **Cistern** – Construction of a green roof/cistern stormwater harvesting system must be as designed, ensuring that the waterproofing components are effectively installed before adding any soil media.
- **Irrigation system** – The irrigation system must be tested for proper operation and that it is capable of irrigating all planted areas at design rates and not wetting impervious surfaces.
- **Load bearing certification** – A structural engineer must certify that the building is able to support the additional weight of a green roof. In general, weights range from 10–35 lbs. per square foot for extensive roofs and 45–100 lbs. per square foot for intensive roofs.
- **Planting method** – Vegetation mats, individual plugs or potted plants, or seeds may be used for planting. Seeds will require the most hands-on effort to establish and mats or sod the least work. It is important to get full surface coverage quickly, as vegetative cover and mat-forming roots prevent loss of media in high winds.¹²⁰
- **Training** – Training and written instructions/manuals for operation and maintenance should be provided to staff and property owners who will be responsible for ongoing care of the green roof.
- **Inspecting and establishing plants** – Frequent irrigation and inspections are necessary until plants are well established. Protect media from erosion, ensure that drains are clear, and that the waterproofing membrane is intact.

CISTERNS AND RAINWATER HARVESTING¹²¹

Rainwater harvesting is usually paired with rain gardens, irrigation systems, or other beneficial use for the stored water, and coordination is needed during their construction. Other considerations include:

¹¹⁸ Byers, P., Cisar, J. L., Fitzpatrick, G. E., Gallaher, R. N., Graham, J. H., Joyal, ... Stratton, M. L. (1998). *Compost use in Florida*. Florida Center for Solid and Hazardous Waste Management, for the Florida Department of Environmental Protection. Retrieved from http://www.floridacenter.org/brochures_bulletins/compost_use_in_florida.pdf

¹¹⁹ Wanielista, & Livingston. (2016, September). Escambia County LID BMP Manual.

¹²⁰ Prevatt, D. O., Acomb, G. A., & Masters, F. J. (2012). *Comprehensive wind uplift study of modular and built-in-place green roof systems (No. UF01-12)* (p. 119). University of Florida. Retrieved from http://www.floridabuilding.org/fbc/commission/FBC_0812/HRAC/Task_2_Final_Report_Green_Roof.pdf

¹²¹ Wanielista, & Livingston. (2016, September). Escambia County LID BMP Manual.

- **Onsite verification** – The sizing and operation of all components must be checked and tested for leaks.
- **Ability to discharge “first flush”** – The landscaped area used for first flush diversion must be installed before the harvesting system begins operation.
- **Check safety** – All appropriate safety measures must be met, access to the pump and cistern must be restricted, and non-potable pipes must be labeled as “Non-potable. Do not drink.”
- **Back-up power** – Depending on the end use of the water, back-up power and leak detection may be recommended.
- **Buoyancy** – Underground tanks must be safeguarded from buoyancy.

EXFILTRATION TRENCH (UNDERGROUND STORAGE AND RETENTION)

Exfiltration trenches depend on soil permeability, like other infiltration SCMs, so preventing compaction must be a primary goal during construction.

- **Excavation method** – A backhoe must be used to excavate the trench to minimize sealing of the soil surface.
- **Placement of excavated materials** – Excavated materials must be placed away from the sides of the excavated area to minimize the risk of sidewall collapse and prevent the excavated material from moving into the trench.
- **Divert stormwater during construction** – Ensure that stormwater does not enter the trench until the contributing area is stabilized.
- **Prevent puncture of filter fabric** – The bottom and side walls of the trench must be inspected for materials such as tree roots or rocks that could puncture or tear the filter fabric. Any such materials must be removed.
- **Inspect for proper function** – The trench should be draining after rainfall such that it is normally dry; restore capacity if needed to meet the design requirements.
- **Maintenance sumps** – Must be located in inlets.

PERVIOUS PAVEMENT

Pervious pavements require careful attention to all aspects of placement. Contractors must be trained and certified by the product manufacturer to install the proposed pervious pavement system according to approved design specifications.

- **Filter fabric** – Must be installed in accordance with the design specifications and punctures must be prevented. Once the subgrade elevation has been reached, the area must be inspected for materials, such as tree roots, that could puncture or tear the filter fabric, and any found must be removed.
- **Subgrade soil compaction** – The in-situ or imported subgrade soil must be compacted to a maximum of 92%–95% Modified Proctor density (ASTM D-1557), at least 24 inches deep.

- **Aggregate placement** – Aggregate must be inspected prior to placement to ensure it meets size specifications and is washed to minimize fines and debris. It should be spread uniformly to the appropriate thickness.
- **Mix inspection** – Pervious pavement mixes must be tested to assure it meets specifications before it is accepted and poured.
- **Sediment from adjacent areas** – Stormwater from adjacent areas must be directed away from the pervious pavement until they are stabilized to prevent clogging.
- **Signage** – Before the pervious pavement is placed into operation, signs must be installed at all entrances advising users that they are entering a pervious pavement parking lot and that vehicles with heavy wheel loads or muddy tires should not enter.
- **Alternative procedures** – Alternative construction procedures may be proposed to ensure that the design infiltration rate of the pervious pavement is met.

RETENTION PONDS

The effectiveness of retention basins can be strongly harmed by inappropriate construction methods or sequencing of site construction. Because stormwater management systems are required to be built during the initial phases of site development, retention basins are often exposed to poor quality surface runoff. Considerable amounts of suspended solids, organic material, and trash may be carried into retention basins. Clogging can occur from subgrade stabilization material used under roadways and paved areas as well as from fine particles that may be released from disturbed soil during construction.

To avoid degradation of retention basin infiltration capacity, the following construction procedures are recommended:

- **Initial pond construction** – First, excavate the basin bottom and sides to approximately 12 inches above final design grades.
- **Lightweight equipment** – Excavation should be done with lightweight equipment to minimize soil compaction. Tracked, cleated equipment compacts soil less than equipment with tires.
- **Final pond construction** – After the drainage area contributing to the basin has been fully stabilized, the interior side slopes and basin bottom should be excavated to final design specifications. Excess soil and undesirable material must be carefully excavated and removed from the basin to remove any accumulated fine sediment within the pond. The excavated material must be prevented from being carried back into the retention basin.
- **Reestablish permeability** – Once the basin has been excavated to its final grade, the entire basin bottom should be deep raked and loosened for optimal infiltration. The depth to be raked is dependent on the type, weight, and contact pressure of the construction equipment used during the bulk excavation of the basin. Alternative construction procedures may be used, provided that the design infiltration rate of the retention basin is met.

TREE BOX FILTERS

Planter boxes may be either open at the bottom for infiltration or may require an underdrain that discharges downstream. They are usually concrete and may be constructed onsite or pre-cast; however,

other materials can also be used. Chemically treated wood should not be used due to the potential for leaching contaminants.

- **Impervious bottom** – If the planter bottom is to be impervious, then the box should be constructed in a single pour, or a waterproof liner may be installed up to the high water mark.
- **Media depth** – The top of the installed media should be below the curb, with at least two inches of freeboard.
- **Selection of trees** – Trees chosen must be suitable for the location, resistant to wind damage, and matched to the volume of the box when mature.
- **Protect nearby buildings** – If the planter is located close to buildings, then special attention is needed to ensure that it is waterproof.

VEGETATED SWALES

The following construction procedures are required to avoid degradation of the swale's infiltration capacity due to construction practices:

- **Verify design dimensions** – Ensure that lateral and longitudinal slopes meet permitted design requirements and will not erode due to channelized flow or excessive flow rates.
- **Design roughness** – Ensure that the vegetation used in the swale is consistent with values used for Manning's "n" in the design calculations.
- **Final grading and sediment removal** – Final swale grading and planting should not occur until the adjoining areas draining into the swale are stabilized. Any accumulation of sediments that does occur must be removed during the final grading stages. The bottom should be tilled to produce a highly porous surface.
- **Protect vegetation during establishment** – Ensure that measures are in place to divert runoff while vegetation is being established on the side slopes and bottom of the swale. If runoff can't be diverted, then vegetation must be established by staked sodding or by the use of erosion control blankets or other appropriate methods.
- **Alternative construction procedures** – An applicant may propose alternative procedures to assure that the design infiltration rate of the swale system is met.

VEGETATED BUFFER STRIPS

The most important requirement of vegetated buffer strips is simply that appropriate vegetation is planted densely enough to provide good cover of the area and that it be protected until well established.

- **Protect existing vegetation** – The existing vegetation, except exotic species, is not to be disturbed during or after the construction of the project. Any new plantings must be Florida-Friendly plants.
- **Remove excess exotic/nuisance plants** – Exotic or nuisance plants cannot exceed 10% of all vegetation. Excess exotics or nuisance plants must be removed.
- **Minimize fertilizer use** – Fertilizers may only be applied if soil and/or leaves indicate a specific nutrient deficiency. If necessary, certified commercial personnel may apply only fertilizers that

are specifically approved and formulated for use on urban landscapes. They must contain little or no phosphorus, have at least 25% slow release nitrogen, and meet the requirements set in Rule 5E-1.003, F.A.C.

- **Prevent erosion** – Ensure that the slopes will not erode or form gullies. During construction, adjacent contributing areas must be stabilized with sod or erosion control blankets or other appropriate measures.

INFILTRATION BASINS

An infiltration basin is normally dry and can hold a design treatment volume until it is infiltrated into the soil. During construction, precautions must be taken to not compact the natural soil in the basin. Inadequate protection during construction can reduce the effectiveness of the completed basin. Specific sequencing is necessary during construction.¹²²

- **Initial excavation** – Initially construct the retention basin by excavating the basin bottom and sides to approximately 12 inches above final design grades.
- **Lightweight equipment** – Excavation must be done by lightweight equipment to minimize soil compaction. Tracked, cleated equipment compacts soil less than equipment with tires.
- **Final excavation** – After the drainage area contributing to the basin has been fully stabilized, the interior side slopes and basin bottom are excavated to final design specifications. The excess soil and undesirable material must be carefully excavated so that all accumulated silts, clays, organics, and other fine sediment material are removed.
- **Dispose of soil** – The excavated soil must be placed in a location where it will not be washed back into the basin.
- **Rake bottom of basin** – After the basin has been excavated to final grade, the entire basin bottom must be deep raked and loosened for optimal infiltration. The depth to be raked will be dependent on the type, weight, and contact pressure of the construction equipment used during excavation of the basin.

CHECK DAMS

The purpose of check dams in swales is to decrease velocities, allowing some particulates to settle and more time for infiltration to occur. Retention times should not be increased where water will not infiltrate within a reasonable number of hours.

- **Soil characteristics** – Verify that a geotechnical investigation has indicated that the soil is appropriate for infiltration.
- **Level swale bottom** – Ensure that the bottom of the swale (or other location) is level to prevent channelization.
- **Location** – Check dams should be placed to create the desired slope and flow velocity.
- **Prevent erosion and flow bypass** – The material used (stone, stop logs, or earthen berms) should not erode and should tie in to the swale sides to prevent bypass.

¹²² Messer. (2010). *Draft stormwater quality applicant's handbook*.

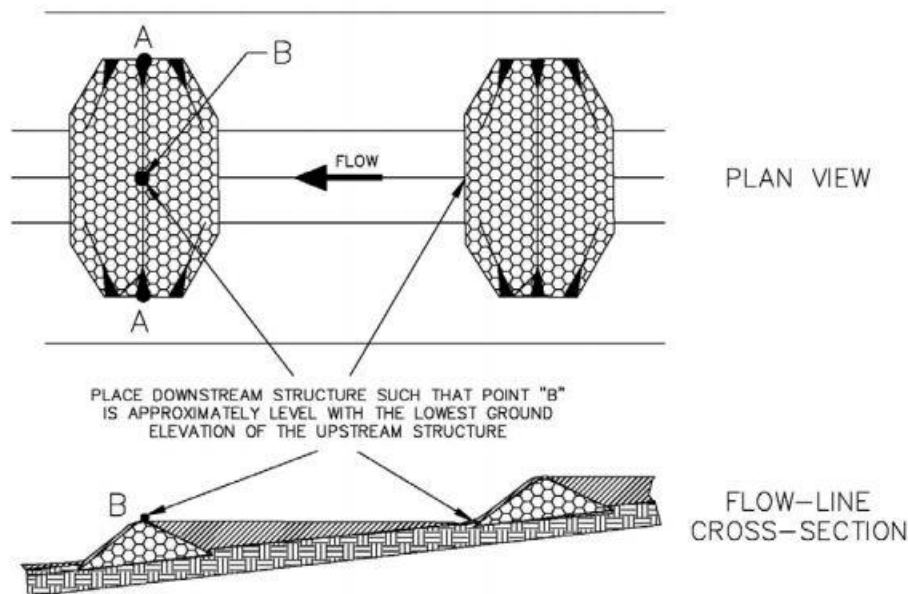

Figure 6-5. Check dams for small drainage channels.

SPLITTER BOXES

A common flow splitter box design sends initial flow into the treatment SCM through a pipe with an invert elevation set at the lowest flow stage. After the treatment volume has been discharged, excess stormwater is diverted over a weir, bypassing the treatment SCM and continuing along the main drainage path. For this type of design:

- **Weir elevation** – The weir elevation must be set at the correct elevation, equal to the water surface elevation at the top of the treatment volume.
- **Pre-screening** – If an open channel leads into the splitter, then a screen is needed to remove any trash and debris.

FLOW SPREADERS¹²³

Flow spreaders are to evenly distribute stormwater; therefore, the most important construction issue is to ensure that it is level.

- **Tie to high ground** – The ends of the flow spreader must extend beyond the flow surface and be tied to higher elevations to avoid flow bypassing the spreader.
- **Secure installation** – The spreader must be made of a durable material and securely installed, often with anchor posts made of concrete or steel.
- **Even slope** – Evenly slope the surfaces over which water will flow to prevent erosion.

¹²³ Jon M. Hathaway, William F. Hunt. (2006). *Level Spreaders: Overview, Design, and Maintenance* (Urban WaterWays No. E07-45839) (p. 7). North Carolina Cooperative Extension. Retrieved from <http://chesapeakestormwater.net/wp-content/uploads/downloads/2012/01/LevelSpreaders2006.pdf>

SPLASH BLOCKS/RIPRAP AT PIPE OUTLETS¹²⁴

Splash blocks are used to dissipate the force of water exiting a pipe or entering through a curb cut or other narrow opening.

- **Suitable material** – Blocks may be riprap, natural stone, or concrete. Rock should have an angular shape to interlock for stability.
- **Riprap size** – If riprap is used, it should be the smaller, ditch lining size, not large boulders used on shorelines.
- **Filter blanket** – Water should flow over the splash blocks and not erode the ground between them, so a filter blanket may be needed between the rock and the natural soil.

IN-STREAM BIOREACTORS¹²⁵

Bioreactors may be different forms installed as beds or walls of woodchips underground, or they may be located in a confined channel for denitrification in stormwater. This is a newly developing technology, and individual designers will have specific requirements for their installation, operation, and maintenance.

- **Geotextile liner** – A liner should be installed on three sides, under and around the sides of the bed.
- **Flow path** – At the design pool level, flow must flow freely through the bed, with provisions made for high flow bypass.
- **Anchor bioreactor** – The bioreactor bed must be securely anchored in place, so that it will not be dislodged under all flow conditions.

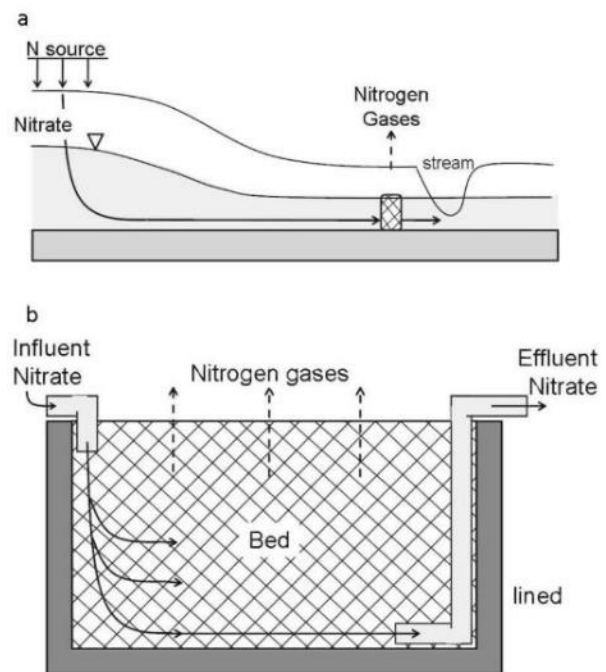

Figure 6-6. Side views of in-stream bioreactors (a) wall or (b) bed.

FILTER SYSTEMS

Stormwater filter systems must be tailored to the pollutants to be removed, and they can be used in conjunction with several types of SCMs. Construction considerations will be associated with the location and use. Manufactured filtration systems are often made to fit in round manhole structures or in rectangular vaults. The media may be contained in removable units. Filtration may also be incorporated

¹²⁴ FDOT Office of Design. (2019, January). *Florida Department of Transportation Drainage Design Guide*. Retrieved from https://fdotwww.blob.core.windows.net/sitefinity/docs/default-source/roadway/drainage/files/drainagedesignguide.pdf?sfvrsn=a32217e4_2

¹²⁵ Addy, K., Gold, A. J., Christianson, L. E., David, M. B., Schipper, L. A., & Ratigan, N. A. (2016). Denitrifying Bioreactors for Nitrate Removal: A Meta-Analysis. *Journal of Environmental Quality*, 45(3), 873–881. <https://doi.org/10.2134/jeq2015.07.0399>

as part of an underdrain with either a bioretention basin or permeable pavements. The filtration media is intended for years-long effective functioning, and access to the media may not be provided.

- **Manufacturer installation procedure** – Follow manufacturer’s instructions for installation.
- **Hydraulic loading** – Ensure that the range of hydraulic loading rates are within the system design for correct performance.
- **Maintenance plan** –A long-term maintenance plan must be provided.

SAND FILTERS

- Sand filters¹²⁶ may be located at the surface, underground, or around the perimeter of a parking lot. [Sample CAD images](#) for sample construction drawings are available from the Minnesota Stormwater Manual. All filters must be protected from surface sediment during construction.
- **Surface sand filter** – A splitter box diverts initial flow to the filter so that the filter is located offline. The filter is usually about 18 inches deep. Runoff enters at the top and is collected by perforated pipes below.
- **Perimeter sand filters** – Two adjoining trenches are installed parallel to the edge of the parking lot, where they will receive surface runoff. The first trench should contain a permanent shallow pool to provide pre-treatment. The second trench holds 12–18 inches of sand and/or other media for filtration.
- **Underground sand filter** – These are underground vaults. One design option contains three chambers: the first is for pre-treatment, the second contains a sand filter, and the third serves as an overflow chamber. Provision must be made to exclude oil and grease from the filter. Overturned pipe elbows connect the first chamber to the second to allow flow to pass through while preventing contamination of the filter.

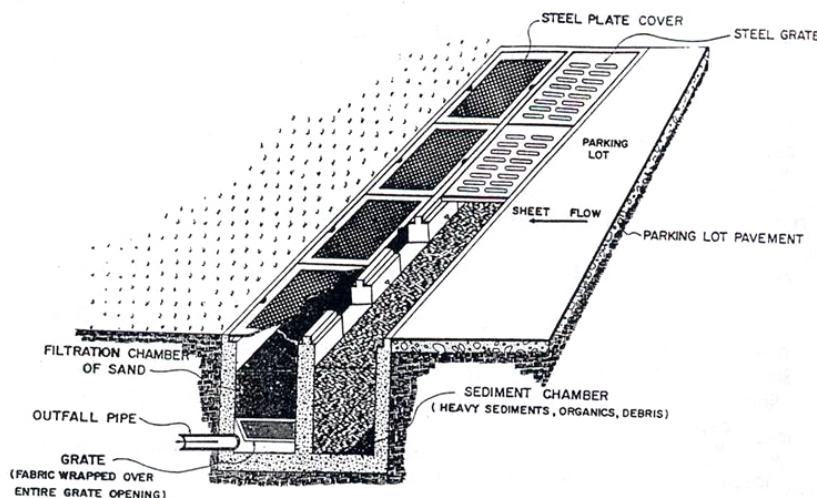

Figure 6-7. Perimeter trench sand filter. (Image: Minnesota Pollution Control Agency)

¹²⁶ Minnesota Pollution Control Agency. (2016). Types of filtration. In *Minnesota Stormwater Manual*. Retrieved from https://stormwater.pca.state.mn.us/index.php?title=Types_of_filtration

BASIN INSERTS¹²⁷

Basin inserts capture larger diameter particulates from stormwater. They should be installed early, during construction, but they should not be the only mechanism for capturing sediment. Regular inspection and maintenance is needed, particularly during construction. Ensure that stormwater flows unobstructed through the insert.

NUTRIENT SEPARATING BAFFLE BOXES

Second generation (nutrient separating) baffle boxes have several components that improve on older versions and remove nutrients and flow control. They are enclosed concrete units that often contain screens for filtering debris and filters with proprietary media for nutrient removal.

- **Proprietary systems** – The manufacturer’s guidance for installation must be followed. Ensure that all connections are properly made and that influent and effluent elevations are correct.
- **Access** – For filters and screens maintenance, the top of the unit must remain accessible.
- **Bypass flow** – Ensure that provisions have been made for high flows to bypass the unit or if the components in the unit become blocked.
- **Inspection** – Frequent inspection and maintenance of the unit will be needed, particularly after storm events. Provide instruction to staff as appropriate.

ENHANCED STORMWATER PONDS¹²⁸

An enhanced stormwater pond (similar to a constructed wetland) can be created in existing wet retention ponds by constructing multiple cells of varying depths and plant habitats. Essential components are:

- **Forebay** – This should comprise about 10% of the treatment volume and be planted with species that can tolerate and absorb metals.
- **Lengthened flow path** – Internal berms can be created to direct flow paths. They should be planted with vegetation appropriate for a littoral zone.
- **Shallow cell** – Most nitrification occurs in a shallow zone also planted with appropriate aquatic species on the shoreline and extending into the basin.
- **Deep cell** – A depth greater than 8-10 feet is recommended to create anoxic conditions for denitrification.
- **Coverage** – Ensure that all embankments have native or suitable vegetation coverage. Any that do not become established must be replaced, along with invasive vegetation.

¹²⁷ State Erosion and Sediment Control Task Force. (2013, July). Erosion and Sediment Control Designer and Reviewer Manual. Florida Department of Transportation and Department of Environmental Protection. Retrieved from https://fdotwww.blob.core.windows.net/sitefinity/docs/default-source/content2/roadway/drainage/files/erosion-sediment-control.pdf?sfvrsn=719d1965_0

¹²⁸ UF PREC, Alachua County Draft LID Manual

- **Maintenance** – At a minimum, maintenance should include the following actions:
 - Inspect the pond quarterly or after significant storms.
 - Harvest accumulated vegetation after about 50% of the open water area is covered by plants. The material should be disposed of outside of the drainage basin.
 - Remove accumulated forebay sediment as needed.
 - Inspect and repair embankments if damaged.

FLOATING WETLANDS¹²⁹

Floating wetlands in stormwater ponds are becoming a popular do-it-yourself project with how-to videos online, and many claims are being made about their benefits. This is a positive trend, encouraging public concern about stormwater quality, but to be effective, their size matters and, as always, maintenance is essential.

- **Area and depth** – Coverage of the pond area is recommended to be at least 5% of the surface area and be located in an area where the minimum water depth is at least 3 feet or greater if the roots of vegetation chosen may grow longer. If roots are allowed to grow into the soil, the mat may not float and become submerged when the pond water level increases.
- **Anchoring** – Mats must be anchored to the bottom of the pond.
- **Proprietary systems** – Manufacturer’s installation instructions must be followed.
- **Root protection** – It may be necessary to use netting to protect roots from turtles, fish, or other wildlife that eat the exposed plant roots.
- **Protection from toxins** – If there is potential for significant amounts of oil and grease or other substances that may be toxic to the plants, pre-treatment may be required above the pond inlet.
- **Coverage** – After 6 months, the mats should be at least 90% covered with vegetation. No more than 10% of the vegetation should be nuisance species.
- **Operations and Maintenance** – A management plan must be prepared to schedule inspection and harvesting. Plants should be replaced at least annually and removed from the basin area.

ONSITE WASTEWATER TREATMENT

The Florida Department of Health regulates onsite sewage treatment and disposal systems (OSTDS) in the state. Many contractors are licensed to install traditional systems, but, as previously discussed, in many areas improved treatment is needed and increasingly will be needed if groundwater levels rise with higher sea levels. If existing systems are upgraded to more advanced treatment, one of the systems [approved for nitrogen reduction](#) is recommended. Although the Health Department specifies them for spring protection, they are equally applicable for reducing nitrogen where shallow depth above groundwater is present.

- **Construction methods** – Instructions will be specific to the individual system chosen, but performance should be verified by a design engineer.

¹²⁹ Wanielista, & Livingston. (2016, September). Escambia County LID BMP Manual.

- **Design efficiency** – A system capable of at least 65% nitrogen reduction should be selected for shallow groundwater, including:
 - [Aerobic Treatment Units](#)
 - [Nitrogen Reducing performance-based systems](#)

An [incentive program](#) is offered by the state to subsidize conversion costs up to \$10,000 to add nitrogen-reducing technologies to existing systems. Unfortunately, at present this is limited to homes in spring protection areas.

LIVING SHORELINES

Living shorelines encompasses a diverse range of options to restore natural habitats to highly modified and often hardened coastal land. They may still incorporate a hardened component to protect the shoreline from wave and storm erosion, but they add vegetation such as mangroves or sea grasses. Sandy barrier islands and oyster beds are being created as well to restore biological diversity and improve water quality.

Living shoreline projects in estuaries need an ERP from the SFWMD or regional DEP regulatory office. For beach-front properties, a [Joint Coastal Permit](#) (JCP) is needed from the State Division of Water Resources for activities that extend seaward of the mean high water line, and a [Coastal Construction Control Line](#) (CCCL) permit is required to protect dunes and coastal ecosystems from harm by construction projects. Florida's [Beach Management Funding Assistance Program](#) may provide financial assistance for restoration and protection projects. The FDEP's [Map Direct](#) website has the most recent aerial imagery and coastal attributes. It can be helpful for conceptual work on shoreline projects.

The description of construction considerations for these projects is highly specialized and beyond the scope of this manual. Many resources from the [Living Shorelines Academy](#) can address specific project needs.

7. OPERATION AND MAINTENANCE OF SCMS

Foundational to providing assurances of long-term performance and cost-effectiveness of any SCM system—LID/GI or conventional—are effective operations and maintenance (O&M) procedures. O&M practices refer to the activities necessary to ensure that SCMs continue to function and manage land-based sources of pollutants over time. As with any engineered or biological system, regular inspection and testing is necessary to either verify that SCMs are operating as designed or to identify problems leading to sub-optimal performance so that appropriate maintenance can be scheduled to restore SCM functionality. While each SCM in a treatment train will have a unique set of O&M requirements for optimizing performance, some O&M considerations, particularly those of a procedural nature, are broadly applicable across a spectrum of LID/GI practices. Chapter 7 addresses the following questions about O&M of LID/GI SCMs:

1. *What conditions might impair or restrict SCMs from operating as designed?*
2. *What are common indicators of impaired SCM performance?*
3. *What maintenance procedures should be implemented to identify and resolve operation problems in a timely manner?*
4. *Are there specific guidelines for long-term O&M of non-structural LID/GI SCMs?*

Key take-home messages include:

- Site visit schedules and inspection metrics should be developed as part of a long-term O&M plan for any SCM system.
- Even when automatic monitoring (e.g., to collect flow and/or water quality data) is integrated with the system, periodic onsite inspections are recommended to identify other factors affecting the system performance.
- Visual inspections alone can save time and money over the long run by identifying and addressing potential operational problems before they have a significant effect on system function and performance.
- For non-structural SCMs (e.g., Florida-Friendly Landscaping™), maintenance activities of irrigation and fertilization should be monitored and recorded to ensure adherence to recommended guidelines and/or regulatory requirements.

7.1. Operation Considerations

It can be helpful to consider the primary functions of an SCM (Section 4.2). The performance of each SCM depends on fundamental processes continuing to occur. These processes can eventually degrade with regular system operation, however. For example, filters trap sediment by allowing through flow while retaining particles of a certain size. Over time, the filter will clog as more sediment is trapped, and that sediment traps increasingly smaller and smaller particles. Similarly, sedimentation can fill in a forebay (an entry section of a pond designed to slow inflow and capture most sediment where it can more easily be removed) or basin, reducing the volume and settling time of particles, ultimately reducing efficiency.

The type of land use and activities surrounding an SCM can impact its operation. For example, sediment source areas draining to filters can accelerate clogging and reduce efficiency. Source areas should be stabilized to prevent unnecessary sedimentation. Proper site design can help avoid these scenarios.

Landscaped beds should not be located in areas adjacent to permeable pavements, but instead include a curb, border, or grass buffer in between them.

7.2. Maintenance Procedures and Frequency

Maintenance refers to the procedures that are needed to maintain the intended operating conditions of the SCM. As operation declines over time, maintenance must be conducted to regularly restore functionality over the long-term. Maintenance-free SCM does not exist. Eventually, every SCM will fail if not properly maintained on a regular basis.

An O&M plan is recommended for all SCMs on a site. This plan should include inspection procedures and frequencies, and the maintenance necessary to correct any identified deficiencies. It is recommended to develop and review the O&M plan with the site owner before construction is completed on the site. Each SCM should have a set of inspection and maintenance procedures, and corresponding activity logs and records should be retained by the party responsible for maintenance activities, with copies provided to the property owner.

Regular site inspection should be part of any O&M plan. The longer an SCM goes without being inspected, the greater the likelihood that function has degraded due to regular operation or unexpected events. While each type of SCM has particular inspection and maintenance practices, the focus is to ensure the continuous function of each part of the system. Regular inspections can help identify signs of decreased functionality and the need for appropriate maintenance. For example, standing water within an infiltration SCM for an extended period would likely indicate the infiltration function of the system is not working as designed and may be clogged in some way. If clogged, this would require removal of the clogging material to restore the infiltrative capacity of the system.

Maintenance practices common to many SCMs include:¹³⁰

1. Remove all clogging material, such as fine sediments, oils, greases, algae, or microbial growth (Figure 7-1).
2. Remove excess sedimentation and/or debris.
3. If sedimentation seems excessive, investigate the contributing area upstream for the source and make repairs as necessary (Figure 7-2).
4. Check for scour on slopes and around influent pipes. Repair any eroded areas and stabilize the soil surface within the SCM and contributing areas.
5. Ensure that stormwater is following the intended flow path and that bypasses or blockages are not occurring.



Figure 7-1. Clogged drawdown orifice. (Photo: Tim Kelly Wood Environment & Infrastructure Solutions, Inc.)

6. Look for standing water where it should not be or water that drains too slowly (Figure 7-3).
7. Maintain healthy vegetation by irrigating, pruning, mowing, and replacing plants as needed.
8. Replace dead or diseased vegetation and mulch to eliminate exposed soil areas.
9. Remove weeds, including invasive and nuisance species.
10. Look for evidence of unacceptable water quality, including algae, hydrocarbons, and odors.
11. Mitigate soil compaction by tilling it, and amend soil if necessary.
12. Look for any broken or missing parts of an SMC that could create a safety hazard.
13. Repair any components of the system (e.g., pumps and structures) to restore flow and filtration.
14. Replace media being used for pollutant removal on a regular schedule.
15. Check for anything that could compromise structural integrity, including evidence of leaks and animal burrows.
16. If public access to the SCM is not intended, ensure that fences or barriers are intact.



Figure 7-2. Sedimentation in inlet pipes. (Photo: Tim Kelly Wood Environment & Infrastructure Solutions, Inc.)

¹³⁰ Timothy Kelly, P.E. (2015, September). Inspection and maintenance of BMPs. Presented at the Florida Stormwater Association, BMP Seminar, Orlando, FL. Retrieved from <https://www.florida-stormwater.org/assets/MemberServices/Seminars/2015/4-inspection%20and%20maintenance%20of%20bmps%20kelly.pdf>



Figure 7-3. Failure of permeable pavement. (Photo: Tim Kelly, Wood Environment & Infrastructure Solutions)

7.3. Regulatory Maintenance Requirements

Regulatory agencies will typically require assurance that permittees inspect and maintain their systems before they can be recertified. Inspection frequency may be specified in permitting documents or by other documents. Inspection and maintenance activities should be recorded in a maintenance log that is kept onsite and that can be reviewed upon request. The maintenance log should include inspection dates and times, maintenance dates and activities, any replaced components, and water volume passing through the system. Some maintenance activities, such as soil testing, may require a registered professional to perform them in order to comply with permit requirements.

7.4. Florida-Friendly Landscaping™

High levels of nutrients are associated with excess fertilizers applied to maintain urban landscapes. By using native plants or others that flourish in the soil and climate conditions, inputs of fertilizers, pesticides, and water can be greatly reduced. They generally require less maintenance time and expense. However, when fertilizers are needed on lawns, Florida-Friendly urban turf fertilizers must meet the labeling criteria below

PHOSPHORUS

Fertilizers labeled for urban turf or lawns must meet the following criteria:

- Labels must indicate that the fertilizer is either no phosphate or low phosphate.
- “No phosphate” fertilizers should not contain more than 0.5% of available phosphate expressed as P2O5. The guaranteed grade for available phosphorus must indicate a zero.
- Fertilizers labeled as “low phosphate” should have use directions that do not exceed an application rate of 0.25 lbs. P2O5/1000 sq. ft. and not to exceed 0.50 lbs. P2O5/1000 sq. ft. per year.

Fertilizers labeled as, or formulated for use as, “starter fertilizer” must have use directions that do not exceed an application rate of 1.0 lb. of P₂O₅/1,000 sq. ft. and that subsequent applications must be made with products meeting the definition of low or no phosphate fertilizers. The term “starter fertilizer” must be part of the brand name.

NITROGEN

Fertilizers labeled urban turf or lawns must meet the following criteria:

- Directions for use for nitrogen must not exceed the annual nitrogen applications rates for the type of turf specified below (Table 7-1).
- Nitrogen should not be applied at an application rate greater than 0.7 lbs. of readily available nitrogen per 1,000 sq. ft. at any time based on the soluble fraction of formulated fertilizer.
- Not more than 2 lbs. of total nitrogen per 1,000 sq. ft. per application may be applied during the spring or summer.
- Not more than 1 lb. total nitrogen per 1,000 sq. ft. per application may be applied during the fall or winter.
- If a total controlled release product is applied, then not more than 35% of the nitrogen in the controlled release fertilizer can be released within the first 7 days after application.

Table 7-1. Maximum recommended nitrogen applications (lbs.) per 1,000 sq. ft. of turfgrass.

Season	Bahia	Bermuda	Centipede	St. Augustine	Zoysia
<i>Spring and Summer</i>	2	2	2	2	2
<i>Fall and Winter</i>	1	1	1	1	1
<i>Annual maximum</i>	3	5	2	4	3

FLORIDA WATER STAR PROGRAM

The Florida Water Star program seeks to encourage water conservation by awarding certification in either residential, commercial and institutional, or community categories. Points are awarded for specific design features that are likely to reduce water use, and if sufficient points are credited, properties are certified as attaining either silver or gold level Florida Water Star accreditation.

The measures that can be credited fall into one of three areas: indoor, irrigation system, or landscape criteria. For pollution prevention, the landscape criterion is the most relevant, but outdoor irrigation also can play a role.

IRRIGATION SYSTEM CRITERIA

Excessive irrigation of landscapes is a concern if excess water discharges into stormwater drainage systems or if irrigation occurs too soon before rainfall, making the ground less able to absorb stormwater, leading to increased runoff volumes. To lessen this risk, Florida Water Star specifies, in part:

- No more than 50%–60% of the total landscaped area be irrigated with high-volume sprayers for silver/gold status.
- Micro-irrigation must be used for landscaped beds.
- Turf and landscaped bed areas are on separate zones.
- Any sprinklers in low-lying areas have check valves.
- Overspray on impervious surfaces is minimized.
- A correctly functioning rain sensor/shut off device is installed.
- The homeowner has received documentation and training on system controls, maintenance and local water rules.

LANDSCAPE CRITERIA

- 10%–30% of the lot remains undisturbed in a natural state with no supplemental irrigation.
- Unirrigated drought-tolerant turf or ground cover is used.
- Organic soil amendments are incorporated into the top 8 inches of the soil.
- All downspouts are directed to pervious areas.
- Innovative landscape water conservation is used.
- For properties bordering a water body, a minimum 10-foot vegetated buffer is installed; for non-irrigated vegetated terraces, swales or berms are used to prevent stormwater from entering the water body.

8. PERFORMANCE VERIFICATION & VALIDATION

Verifying the performance of SCM function as designed and installed is a critical part of ensuring effectiveness, documenting adherence with required standards, and identifying opportunities and mechanisms for achieving more comprehensive water quality protection and management goals. While the responsibility of operation and maintenance typically falls to the land owner and permitted entity, performance verification is generally the responsibility of the permitting agency. Each plays a part in ensuring SCMs continued functioning and limiting the liability taken on by the permitting agency or government entity.

Chapter 8 addresses the following questions about SCM performance verification and validation:

1. *Why is performance verification and validation necessary?*
2. *What are best practices for verifying the function of SCMs to meet stormwater volume and peak flow reduction requirements and/or goals?*
3. *What are best practices for verifying the function of SCMs to meet water quality treatment standards and/or management goals for source control of LBSP?*

Key take-home messages include:

- Verifying performance by direct monitoring and sampling of SCM functions is time- and labor-intensive and often expensive. Therefore, performance verification is typically conducted by minimizing the uncertainty of performance using cost-effective methods.
- When the performance of an SCM is found to be impaired, an evaluation¹³¹ may be needed to determine the most cost-effective means of restoring the intended function.
- Restoration may not always be the best option if other SCMs can be added or augmented.

8.1. Volume and Peak Flow Reduction

Managing the volume and rates of runoff are some of the primary functions of SCMs, and other functions, such as water quality improvement, are dependent on these processes. Continued performance of these systems depends on the specific functions of the SCMs. Verification requires an understanding of these functions and respective failure mechanisms. Ensuring performance begins well before the project is completed, with the design and construction phases.

8.1.1. Design

Problems arising during the design phases of the project can permanently diminish the function of an SCM, causing it to never achieve the assumed control of stormwater runoff. Thus, it is important to include appropriate verification testing and reviews during a project's design phases. The costs for correcting or modifying designs are nearly always less than the costs of making the same changes during the construction or post-construction phases.

¹³¹ Erickson, A. J., Weiss, P. T., Gulliver, J. S. (2013). *Stormwater Treatment: Assessment and Maintenance*. Minneapolis, MN: University of Minnesota, St. Anthony Falls Laboratory. Retrieved from <http://stormwaterbook.saf.umn.edu/>

ENGINEERING DESIGN REVIEW

The engineering design review process should verify that proper engineering methods and standards are being used and that the system is being designed to meet the site and regulatory constraints. For SCM design, this includes ensuring that the SCM provides enough storage volume and that the volume can be recovered within the required period. Conveyance structures for inflows, controlled discharge, and overflows should be appropriately sized. Contributing areas and any impeding constraints (e.g., tail water conditions, depth to water table) should be properly accounted for in designs. Design materials should clearly state the methods used, include example calculations, provide the basis for modeling conducted, and include all assumptions. Design documents should demonstrate through accepted calculations or modeling methods that SCM storage volumes will recover the design volumes within the required duration and safely convey flows resulting from design rainfall events.

GEOTECHNICAL INVESTIGATION

Several SCMs rely on infiltration for volume recovery, which is largely controlled by the characteristics of the soil or media being infiltrated. A geotechnical investigation should be required of any SCM designed to recover the storage volume, either partially or completely, by infiltration. The investigation should be performed by a licensed professional who provides a detailed technical report characterizing and evaluating the onsite soils for the intended purpose. The report should also include an estimation of the depth to water table, if it can be determined. The resulting engineering design should not deviate from the results of the geotechnical investigation without reasonable justification.

Infiltration can be restricted due to a shallow water table or restrictive soil layer. Soils with low conductivities can restrict the infiltration rate of more conductive soils overlying them. This can cause water to build up above the restrictive layer as water enters the surface soil faster than it drains through the restrictive soil layer. This saturated layer is known as a groundwater mound and can cause infiltration rates from SCMs to be significantly reduced. If there is a risk for developing a groundwater mound below an SCM, then a groundwater mounding analysis should be included with design documents demonstrating that the system will recover the storage volume within the required period. In addition, observation wells can provide an easy inspection for subsurface water level fluctuations with limited modification to designs.

8.1.2. Construction

The construction process establishes the baseline for long-term SCM operation. Depending on the quality of construction, the system could either function as designed or never function as designed. For example, sedimentation or compaction of the subsoil underlying an infiltrating practice could lead to extended or permanent storage. These errors may not be realized until after construction is completed. Correcting them can require full system replacement.

Therefore, performance verification relies on quality assurance protocols being followed throughout the construction process. This includes inspection and testing of materials, sediment and erosion control, infiltrating surfaces protection, mitigation planning when errors occur, and regular site inspections. Once construction is complete, a final inspection should be performed before the system or facility is accepted by the permitting agency. Prior to acceptance, a set of as-built drawings should be submitted to the permitting agency, and a prescriptive maintenance agreement should be in place. Finally, a file for each

SCM should be created and maintained by the permitting agency to develop a historical record for the site that is easily located and kept up to date for future inquiries.

8.1.3. Post-construction

Once construction has been completed, the regular operation and maintenance of the SCM is expected to keep the system functioning throughout the design life. However, it is recommended that a site be visited to confirm that volume capture and flow attenuation are continually being achieved every 10 years. Due to the large number of SCMs that an agency or local government may have to visit, the inspection should be designed to quickly verify performance at each site.

The most fundamental step is to visually verify that the SCM still exists at its original location. A quick visual inspection can often provide an indication of whether a system is functioning. Some specific indicators can include:

- Ponding beyond design period indicates limited infiltration, potentially due to sedimentation, clogging, or compaction.
- Wetland vegetation growing where it was not intended (areas that should be dry within 72 hours of a rain event). This indicates extended periods of ponding or saturated soils.
- Rack lines indicate recent elevation of flows through the system.
- Bare soil, riprap, or other stone indicates potential excess flow through the system; its presence at an outlet control structure could indicate that the capture volume has been reduced.
- Damaged or malfunctioning inlets or outlets indicate high or low flow rates through system.
- Sediment deposition or erosion indicates a problem, perhaps a changed flow path or uneven distribution of flow (for example, flow eroding paths through a shoreline buffer strip).
- Accumulated sediment or debris can significantly impact the performance of pervious pavements or other infiltration SCMs and can reduce available storage volume in detention SCMs.
- Scheduling inspections during dry periods can provide an indication of SCM flow performance, as infiltrating practices that are holding water for excess durations can be identified.

8.2. Water Quality Standards and Indicators

Verifying water quality treatment performance is generally more difficult than verification for volumes and flow rates.

8.2.1. Sediment load reduction

Reducing sediment loads to downstream waters necessarily leads to sedimentation within an SCM. Thus, the accumulation of sedimentation can be a visual indicator of sediment load reduction. Inspecting for sediment accumulation should be part of a performance verification process. The primary function of a forebay is to trap sediments and gross solids. However, the removal efficiency declines as the forebay fills in over time. Depending on the time since previous maintenance to remove the sediment, the system may have reached equilibrium or the maximum sediment mass removed. Flow paths or erosion, where concentrated flow may occur, through areas of sedimentation are indicators that sediment load

reduction capacity has diminished, and sediment should be removed. Site managers should keep a maintenance log available for inspection. Prior sediment removal should be documented in the maintenance log along with dates and quantities.

8.2.2. Nutrient load reduction

Directly verifying nutrient removal is difficult without instrumentation for monitoring flows and collecting water samples for analyses. Thus, indirect verification of reductions relies on assessing indicators of removal functions. Nutrients can also be present as dissolved or particulates, which have different removal mechanisms. For verifying removal of nutrients, it is important to understand the removal mechanisms that are intended to occur. Further, these processes are different for the particulate and dissolved fractions of nutrient loadings.

The process of nutrient load reduction can occur in a couple of ways: 1) volume reduction and 2) concentration reduction. Load reduction via volume reduction occurs via retention of the volume onsite. This load reduction is in respect to surficial discharge. Thus, the dissolved nutrients may be partially removed by vegetation and microorganisms, and the remaining load moves into groundwater and can be carried into surficial aquifers or supply base flow to nearby streams.

8.2.3. Nutrient concentration reduction

Because nutrient concentration reduction is difficult to assess, it is often assumed that nutrient removal is occurring if the intended process is occurring (e.g., sedimentation, filtration, infiltration). Also consider the expected nutrient removal process and whether the specified maintenance is being done. For example, is media present and being replaced at set intervals? Is enough adsorptive capacity available to continue removing nutrients? It may be necessary to conduct a soil test to determine nutrient capacity. Sample collection at inlet and outlets may be necessary to directly assess water quality.

Finally, to evaluate adequate nutrient removal, look for signs of excess nutrient concentrations in ponds or downstream receiving waters. The presence of algal blooms or residue, the presence of plants that prefer higher nutrient concentrations, or the absence of low-nutrient plants may indicate problems.

9. PUBLIC EDUCATION

Homeowners and the public are important partners to engage with during any LID/GI project or application to reduce and mitigate LBSP. They can assist with crafting educational campaigns to raise awareness of watershed and water quality issues affecting Southeast Florida's coral reef ecosystems and can serve as liaisons between the public and local governments, regulatory and permitting agencies, and non-profit educational and advocacy groups. This chapter addresses a number of questions about public education and partnerships to improve the success and effectiveness of LID/GI projects:

1. *How can public education campaigns and tailored messaging about local watershed issues help advance LID/GI initiatives?*
2. *What are the focus points/messages for public education campaigns that can both raise awareness and prompt behavior change that aligns with LID/GI project goals?*
3. *What public education roles do local governments and other regulatory authorities fill, and what types of local government messaging resonate most with public audiences?*
4. *How can citizens, landowners, business owners, and homeowners contribute to the effectiveness of LID/GI public education and behavior change campaigns?*

Key take-home messages include:

- Improved awareness and understanding of watershed and water quality issues is essential to achieving public acceptance and support for and effective performance of LID/GI projects.
- Public education campaigns should focus on connecting hydrologic, stormwater, and water pollution issues with specific choices and behaviors that resonate with citizens.
- Local governments are in a unique position to provide incentives (regulatory and non-regulatory) for adoption of LID/GI approaches in all types of land development or redevelopment projects. Their staff regularly interact with private-sector professionals and the public, and they have the data, information, and working relationships to develop effective public education campaigns.
- Citizens themselves can also play an important role in protecting water quality, particularly at the source, through their property use, landscaping, lawn care, and consumer product decisions.

9.1. Need for public understanding of water connections, local watersheds, and the hydrologic cycle

One final element needed to improve water quality is the cooperation of the public. The best designed LID/GI infrastructure can be more or less effective depending on the behavior of citizens in the community. This cooperation applies especially to homeowners' plant choices, fertilizer and other chemicals applied to our landscapes, but is also influenced by our water usage, pet waste and trash disposal, and maintenance of stormwater facilities. It is difficult for local governments to implement LID/GI without sufficient support from the public.

Although people may value good water quality, they may not understand the physical connections between rainfall, surface water and groundwater, and our coastal environment. There is a need to improve the public's understanding of the environmental function of stormwater systems. Multiple focus groups and a survey undertaken between 2010–2013 indicate that more than 48% of respondents either "don't know where runoff goes" or "don't know what runoff is." This suggests that many people not only

do not understand the function of stormwater ponds and infrastructure, but they are unaware of their personal contributions to pollution.¹³² Individuals must be aware of the impact of their actions on water quality in groundwater, streams, lakes, estuaries, and the oceans before they will voluntarily make changes in their behavior.

Therefore, education is an important step in ultimately reaching water quality goals. It is easy to focus on government, agriculture, industry, or other roles in causing Florida's water problems, and it is not obvious that we all share some responsibility to make improvements. Two focus points should be included in education programs to help homeowners to connect the dots:

- Connect pollutants such as fertilizers and other lawn care products, pet waste, trash, and lawn clippings with stormwater runoff and the algal blooms fouling our waterways and beaches.
- Connect rainfall, aquifer recharge, and household potable water with the expanding demand for water, aquifer depletion, sea-level rise, and saltwater intrusion into water supply wells.

9.2. Role of Local Governments

Local governments are also crucial partners in the successful adoption of LID/GI projects through their multiple roles in the design and construction industries. They not only pass local ordinances, but they also set land use and zoning, approve development plans, and issue building permits. They have responsibilities to remove barriers to LID and to replace conflicting policies with others that encourage it. They can also provide incentives or water quality credits for implementing LID. Watershed management can be implemented through comprehensive plans and funded through stormwater utilities.

Beyond working directly and indirectly with land development professionals, local governments are perhaps best suited to educate the public about the need to protect water quality for current and future uses. Local governments can help citizens make the connections between our individual choices, such as the application of fertilizers and other products to our landscapes and that storm drains are not appropriate for disposing of used oil or other liquid wastes. Without the public's support, local programs to reduce pollution and better manage stormwater are unlikely to succeed. The question is how best to design a public education program.

Survey results have identified areas where occupants' knowledge and landscape management decisions or practices can be improved to protect pond aesthetics and water quality as well as lowering maintenance costs. One area identified as a problem is that the majority (64%) of homeowners who lived next to stormwater ponds were unwilling to accept unmown buffer strips around their ponds, and a large minority (43%) were unwilling to have aquatic and shoreline vegetation planted.¹³³ Education on the benefits provided by vegetation might counteract these attitudes, such as explaining that algal blooms

¹³² Ott, E. (2015, September 15). *Strategies to encourage adoption of stormwater pond best management practices (BMPs) by homeowners*. Retrieved from <https://edis.ifas.ufl.edu/wc214>

¹³³ Ott. (2015). *Strategies to encourage adoption of stormwater pond best management practices*.

Emily Ott, P. M., Ondine Wells, Gail Hansen, Laura Warner, Michelle Atkinson. (2015, July). *Strategies to Encourage Adoption of Stormwater Pond Best Management Practices (BMPs) by Homeowners*. Retrieved from <http://highlandscdd.com/wp-content/uploads/2016/10/Strategies-to-Encourage-Adoption-of-Stormwater-Pond-Best-Management-Practices-by-Homeowners.pdf>

are reduced when plants take up nutrients, and that habitat provided by aquatic and shoreline plants attract fish, birds, and beneficial insects that can reduce mosquito populations.¹³⁴ Retrofits of existing stormwater ponds would be difficult without improving residents' understanding of stormwater issues.

DECIDE WHAT MESSAGE(S) ARE MOST RELEVANT TO CONVEY

For stormwater systems, the public needs to understand that swales and stormwater ponds serve a purpose beyond just transporting and storing water, but public education messages must be short and to the point. Depending on the specific local situation, individual goals and specific desired behavior changes should be identified.

- Identify a problem.
- Articulate the specific educational message and the desired public actions.
- Avoid terminology that is too technical or abstract for many people and focus on concrete language.
- Messages can focus on either harmful or beneficial actions, but messages that identify (desirable) actions are more likely to change behavior. First, plan out how to deliver the message, then use creative graphics and slogans, multiple media types, and ask respected/authoritative persons or organizations to participate.

9.3. Community Participation: Role of citizens, landowners, business owners, homeowners

The public can play an important role in protecting water quality in several ways. The most apparent is perhaps to reduce stormwater volume and pollutants through better landscape design and management. The UF/IFAS Florida-Friendly Landscaping™ Program [recommends actions](#) that homeowners can take to reduce the amount of stormwater runoff and pollutants in the water. Groups such as Master Gardeners, native plant associations, and IFAS extension agents offer classes, make presentations to local groups, and advise individual homeowners on how to create more sustainable landscapes.

Citizens can report algal blooms to an [FDEP webpage](#) or use 24-hour hotlines to report algal blooms (1-855-305-3903) and fish kills (1-899-636-0511). The SFWMD participates with other agencies to send sampling teams to collect and analyze water samples at reported locations. An [interactive dashboard](#) then displays current locations where algal blooms are occurring throughout the state and other information from lab results on water samples that document the blooms. It also provides information on associated health concerns and updates on measures being taken to address algal blooms.¹³⁵

Protection of coral reefs is advocated by [Friends of Our Florida Reefs](#), [The Nature Conservancy](#), the [Coral Restoration Foundation](#), [Miami Waterkeeper](#), and the [Coral Reef Alliance](#). Many other citizens groups focus on specific water bodies or geographic areas, such as the [Lake Worth Water Keeper](#) or [Indian Riverkeeper](#). They typically publicize water quality issues, do clean-up, conduct public education, and

¹³⁴Ott et al. (2015). *Strategies to encourage adoption of stormwater pond best management practices*.

¹³⁵ Florida Department of Environmental Protection. (n.d.). *Algal Bloom Dashboard*. Retrieved June 11, 2019, from <https://floridadep.gov/algalbloom>

foster a love for Florida's natural environment. Some groups lobby government for changes to legislation and policy.

A list of groups in Southeast Florida that focus on local or regional issues was taken from the 1000 Friends of Florida's publication, *Florida Smart Growth Advocates*.¹³⁶

- [Arthur R. Marshall Foundation and Florida Environmental Institution](#) – Established to develop, promote and deliver science-based education and public outreach programs central to restoration of the Everglades ecosystem and its historic river of grass.
- [Guardians of Martin County](#) – This non-partisan group of residents and voters is dedicated to supporting the integrity of the Martin County Comprehensive Growth Management Plan through increased public awareness.
- [Hold the Line](#) – Formed early in 2005, Hold the Line is a grassroots coalition formed to oppose numerous proposals to expand Miami-Dade County's urban development boundary.
- [Indian River Land Trust](#) – The organization's mission is to promote the preservation, conservation, and improvement of natural resources and special places in Indian River County, Florida for the benefit of the general public and future generations. Its vision is to preserve environmentally important land and water resources, protect scenic waterfront areas, and to provide access for public recreation and education.
- [Martin County Conservation Alliance](#) – This group works to avoid overdevelopment and its impact on Martin County schools, roads, libraries, and taxes through upholding the Martin County Comprehensive Growth Management Plan.
- [Miami River Commission](#) – Formed by the legislature in 1998, the Miami River Commission is the watchdog, advocate, and clearinghouse for the Miami River, which runs 5.5 miles from Biscayne Bay through the heart of Miami. It developed and is helping to implement the Miami River Corridor Urban Infill Plan.
- [Original Save Our Beach](#) – This organization was formed in response to a series of proposed high-rise beachfront projects in the City of Deerfield Beach in Broward County. As a PAC, it campaigned for three successful referenda (in 1998, 2000, and 2002) to limit beachfront development. It now focuses on natural resource protection and planning.
- [Smart Growth Partnership: A southeast Florida Initiative](#) – This group's mission is to promote livable, sustainable, and green communities in South Florida through leadership, support, advocacy, and education.
- [South Florida Audubon Society](#) – This organization fosters conservation through local, regional, national, and global environmental advocacy and activities throughout South Florida with an emphasis on birds and wildlife and their habitat. It serves Broward County, but it also is involved with Palm Beach, Miami-Dade, and Monroe Counties.
- [Tropical Audubon Society](#) – A chapter of Audubon of Florida and the National Audubon Society, Tropical Audubon was established in 1947. It focuses on conservation, education, and enjoyment of the natural world.

Finally, groups that focus on sustainable development, climate change adaptation, and resilience are directly involved in encouraging the use of LID/GI to lessen the current and future impacts to our

¹³⁶ 1000 Friends of Florida. (2018). *Florida smart growth advocates*. Retrieved from <http://www.1000friendsofflorida.org/connecting-people/florida-smart-growth-advocates/>

communities from climate change. These include the Southeast Florida Regional Climate Change Compact and the Institute for Sustainable Communities.

The opportunities for citizens to become involved with community groups working toward improved water quality and local resiliency are excellent avenues to educate the public on these issues. Collectively, the public shares both power and responsibility for improving water quality. Grassroots campaigns are methods to influence policy and ultimately hold politicians and regulatory agencies at the local, state, and national levels accountable to public concerns.

9.4. Successful Strategies (Case Studies, Public Outreach Campaigns)

Several basic steps are important in planning a successful public education program:

- Identify specific problems or gaps in public awareness.
- Select specific behaviors to be changed for targeted messages.
- Select the best messenger, such as veterinarians and managers of apartment complexes for the “Scoop the Poop” campaign.
- Innovative media mix, including 15-second commercials shown before local movie screenings.
- Give specific messages for positive actions in messaging; avoid telling the public “Don’t...”

Some specific techniques that have been successfully used for public education include:

- Demonstration projects.
- Storm drain markers (stencils or stickers) to serve as a visual reminder that anything entering them will drain to a stream/lake/estuary.
- Flyers sent with utility bills.
- Municipal websites.
- Slogans, such as “Slow it, Spread it, Sink it.”¹³⁷
- An eye-catching logo or a mascot.
- Citizen science: water quality monitoring apps, etc.
- IFAS extension agents/programs, particularly on Florida-Friendly Landscaping™, but also on [watersheds](#) and water resources.
- School curricula.

A few examples of successful public education programs in Florida are discussed below.

THINK ABOUT PERSONAL POLLUTION (TAPP)

This program, developed in Tallahassee, tackles public education on multiple aspects related to pollution and water quality. The topics discussed include lawn care, pet waste, car washing, illicit discharge, rain gardens, and rain barrels. Educational materials, including a webpage and many humorous short videos,

¹³⁷ Vermont Department of Environmental Conservation
https://www.uvm.edu/sites/default/files/green_stormwater_presentation_toec2016.pdf

were created (examples [here](#) and [here](#)). Under a “[Get Involved](#)” tab, their website (available at <http://tappwater.org>) targets specific types of businesses with information (concise lists of actions to do or to avoid). The business types are auto repair technicians, construction contractors, farmers, lawn care companies, paint contractors, and restaurants.

Rain gardens have been a large part of the TAPP program since 2007. The program includes a “[How-to manual for homeowners](#),” and workshops offered at plant nurseries and a state park provide step-by-step instructions for planning, building, and maintaining raingardens. Grants are available for residents and institutions to defray their installation costs, and applications are available on TAPP’s website.

However, personnel also give presentations to “all interested groups, no matter how large or small, at virtually any venue,” and they credit the personal interactions as being the most effective method to change individual behaviors.

SCOOP THE POOP

In Alachua County, the Environmental Protection Department designed a [Scoop the Poop](#) program, focused on changing the behavior of pet-owning citizens to reduce fecal coliform in local streams. Their tag line “Scoop it, Bag it, Trash it” concisely described the actions desired by the campaign.

The campaign produced posters, a pamphlet, local television commercials, and a [website](#). A range of useful items for dog owners were given away at public events, such as bag dispensers that could be attached to leashes and keychain flashlights. These were popular and were credited with raising the campaign’s profile. Dog adoption agencies, local veterinarians, and apartment complex managers were recruited to become actively involved.

In a post-campaign survey, about 10% of respondents in the general public reported changing their behavior as a result of the campaign.¹³⁸



Figure 9-1. Poster for Scoop the Poop campaign.

¹³⁸ Alachua County Environmental Protection Department. (2009). *Alachua County Scoop the Poop Campaign, Final Report* (p. 18). Retrieved from http://www.alachuacounty.us/depts/epd/documents/waterresources/final_pet_waste_report.pdf

LASALLE BIOSWALE DEMONSTRATION PROJECT



The St. Johns Riverkeeper and other community groups worked together to install a bioswale and pervious concrete pavement in downtown Jacksonville.

A portion of the runoff from Lasalle Street is now diverted into the bioswale for treatment, rather than flowing directly into the St. Johns River. Commercial and municipal grant funds paid for the project.¹³⁹

Figure 9-2. Volunteers planting the Lasalle Bioswale in Jacksonville, FL.

¹³⁹ <http://www.stjohnsriverkeeper.org/river-friendly/low-impact-development-green-infrastructure/>

10. ANCILLARY COMMUNITY BENEFITS

Beyond providing safe and effective stormwater management, flood control, and water resource protection, LID/GI projects can generate additional environmental, economic, and social/cultural benefits. This chapter summarizes potential ancillary community benefits from use of LID/GI strategies and SCMs, addressing the following questions:

1. *How might LID/GI projects benefit natural systems and promote ecosystem services?*
2. *Can local economies benefit from adoption of LID/GI projects? If so, in what ways are economic benefits realized?*
3. *Do LID/GI benefits extend to social and cultural communities or institutions?*

Key take-home messages include:

- When successfully implemented and maintained, LID/GI projects can generate a range of benefits to the natural environment, such as the provision of wildlife habitat, carbon sequestration, aquifer recharge, improved air quality, biological diversity, and resilience to extreme weather events. The central environmental benefit of interest for this manual, healthy coral reef ecosystems (or avoiding additional coral reef damage and loss) over time, is perhaps the best indicator of successful efforts to reduce LBSP.
- Because our economic systems rely (directly and indirectly) on a plentiful supply of clean water, abundant natural resources, and healthy ecosystems, LID/GI can generate long-run economic benefits such as increased property values, reduced energy bills for cooling, increased revenue from resource-based recreation and tourism, and reduced labor and inputs required to maintain residential and commercial landscapes.
- Finally, while difficult to measure, cultural and social benefits can accrue from the adoption of LID/GI practices and projects, including improved quality of life, safer cities/neighborhoods, and improved public health.

10.1. Ecological and Environmental

Some of the more obvious environmental and ecological rewards from LID include water quality protection, pollution prevention, and reduced stormwater runoff. Practices such as permeable pavements and soil amendments do this through increased infiltration. Rainwater harvesting systems and bioretention cells help achieve this through flow attenuation. The resulting improved water quality and more natural hydrology help to restore and/or maintain the health of surrounding and downstream ecosystems. Many GI technologies, like bioretention cells and enhanced stormwater ponds, can additionally provide wildlife and habitat protection and provision, for both native and migratory species (Figure 10-1).

Technologies utilizing vegetation, such as tree box filters and green roofs, additionally lead to improved air quality.



Figure 10-1. Black skimmers on constructed island, Lake Worth Estuary.

LID also provides resilience and adaptation to climate change through reduced CO₂ emissions and increased carbon sequestration, decreased risk of flood and drought, mitigation of urban heat island effect, and enhanced coastal resiliency.¹⁴⁰

10.2. Economic

LID reduces stress on natural resources that sustain local economies. Though implementation sometimes requires a significant monetary investment upfront, many economic benefits of LID are long-term. For example, green roofs and tree plantings help regulate building temperature, leading to energy savings for heating and cooling. With proper management comes the opportunity for reclamation, reuse, and the protection of drinking water supplies via enhanced infiltration and treatment of stormwater runoff, ultimately leading to a more resilient water supply.

Mixed-use, clustered communities also reduce the need for lengthy commutes from home to work or play, which translates to a monetary benefit for residents. Furthermore, homeowners with rain gardens or lots adjacent to ecologically enhanced stormwater ponds may benefit from increased market value of their homes, particularly as the consumer market for native, low-maintenance landscapes continue to grow. Urban greening has been observed to directly relate to increased property value due to enhanced aesthetics.

“The Value of Green Infrastructure: A Guide to Recognizing Its Economic, Environmental and Social Benefits,” produced by the Center for Neighborhood Technology and American Rivers, provides a framework to help further guide communities in valuation of benefits from potential green infrastructure investments.¹⁴¹

10.3. Social and Cultural

Many LID applications are valued as social or community amenities. It is believed that use of green infrastructure in urban areas can improve community livability and quality of life. Green spaces provide areas for recreation where community members can participate in activities like taking a stroll, walking the dog, or having a picnic. Sullivan, Kuo, and DePooter (2004) described how nature plays an important role in creating neighborhood spaces: “The presence of trees and grass is related to the use of outdoor spaces, the amount of social activity that takes place within them, and the proportion of social to nonsocial activities they support.”¹⁴² Increased social activity between green space users gives rise to a more supportive and interactive community. In fact, Kuo and Sullivan (2001)¹⁴³ reported that the amount of vegetation in an area is related to the amount of crime reported in the area, with less crime reported in greener areas.

¹⁴⁰ US EPA. (n.d.). Green infrastructure for climate resiliency [Infographic]. Retrieved from <https://www.epa.gov/file/green-infrastructure-climate-resiliency-infographic>.

¹⁴¹ Center for Neighborhood Technologies. (2010). *The value of green infrastructure: a guide to recognizing its economic, environmental and social benefits*. Retrieved from https://www.cnt.org/sites/default/files/publications/CNT_Value-of-Green-Infrastructure.pdf

¹⁴² Sullivan, W. C., Kuo, F. E., & DePooter, S. F. (2004). The fruit of urban nature: Vital neighborhood spaces. *Environment and Behavior*, 36(5), 678-700. DOI: 10.1177/0193841X04264945

¹⁴³ Kuo, M., & Sullivan, W. (2001). Environment and crime in the inner city: Does vegetation reduce crime? *Environment and Behavior*, 33. 343–367. DOI:10.1177/00139160121973025.

According to the EPA, urban areas are often warmer than the surrounding natural areas, a phenomenon known as the heat island effect, which can lead to increased energy consumption, elevated emissions of air pollutants and greenhouse gases, compromised human health and comfort, and impaired water quality.¹⁴⁴ Implementation of green infrastructure can help mitigate the heat island effect and the associated repercussions. LID technologies such as permeable pavements and those utilizing vegetation, for example, have the added benefit of reduced noise pollution, which leads to more enjoyable living environments. Additionally, roadway and median swale/tree box/green street applications often calm traffic, improving public safety.

Green spaces also contribute to public health. Improving walkability and increasing recreation areas promotes a more active lifestyle, leading to maintenance of healthier body weights and extended longevity. Green areas have additionally been shown to reduce stress, improve mental health and productivity, and are also associated with healing and treatment of both physical and emotional ailments.¹⁴⁵

The Green Cities: Good Health¹⁴⁶ website provides an overview of the scientific evidence of human health and wellbeing benefits provided by urban forestry and urban greening. Green Cities: Good Health also provides a collection of more than 2,800 scholarly works, most of which are peer reviewed. The research findings are sorted and summarized across benefits themes that include healing, safety, and community building.

¹⁴⁴ U.S. Environmental Protection Agency. (2008). *Reducing urban heat islands: Compendium of strategies*. Draft. Retrieved from <https://www.epa.gov/heat-islands/heat-island-compendium>.

¹⁴⁵ Wolf, K. L. (2014, April 30). *Water and wellness: Green infrastructure for health co-benefits*. Retrieved from <http://stormwater.wef.org/2014/04/water-wellness/>

¹⁴⁶ Wolf, K. L. (2018). *Human health and wellbeing research*. Green Cities: Good Health. Retrieved from <https://depts.washington.edu/hhwb/>.

11. CONCLUSIONS AND NEXT STEPS

11.1. Conclusions

The unique hydrogeology (high water tables, poorly drained soils, lack of elevation, proximity to the coast) creates unique challenges for mitigating Land-Based Sources of Pollution (LBSP) within the four counties of Southeast Florida (Martin, Palm Beach, Broward, and Miami-Dade). In addition, legacy infrastructure (canal systems, drained wetlands, and septic systems) and a lack of policy incentives have made it difficult to change standard development practices and lessen the conveyance of LBSP into receiving waters.

This manual provides technical guidance for professionals who work in planning, development, permitting, review, and policy concerning LID/GI techniques and practices that can be used to address LBSP in Southeast Florida and is intended to serve as a resource for those with limited or no previous LID/GI experience. Relevant information is supplied to take the reader from introduction of the concepts (Chapter 1) to local context (Chapter 2), and on through the planning, selection, installation, maintenance, and validation (Chapters 3–8) of LID and GI techniques. The latter chapters include the importance of the community in the LID/GI process through public education (Chapter 9) and the realization of ancillary benefits (Chapter 10). Of note, design specifications and engineering methods were not within the scope of this manual. However, readers are directed to external resources for further information if desired.

Addressing LBSP is a multi-faceted effort in Southeast Florida and will require coordination among multiple local and regional entities to effectively manage their impacts. There are some indications of progress in reducing land-based pollutants that impair water quality in Southeast Florida estuaries. Several of the positive indicators are due to regulatory actions: TMDL targets and implementation of BMAP plans are requiring local governments to make significant changes to stormwater management, fertilizer policies, and onsite wastewater disposal. Other positive actions have been voluntary due to concern from local governments and the public at large. Many local governments and planning associations have embraced increased density over urban sprawl, preservation of green spaces, and complete streets policies, and the public is demanding nutrient reductions to reduce red tides and the associated economic and biological harms. Plans to adapt to sea-level rise and mitigate damage from tropical storms also indicate a willingness to take on our most serious challenges before they become crises.

11.1.1. Challenges of modeling and monitoring

Despite progress, a number of problems and questions remain. As difficult as it is to determine the various causes of water pollutants, it is similarly complicated to put together a true picture of the results. To assess the true situation, we must answer basic questions: Is progress being made? How effective have individual measures been, and what are the most cost-effective measures to implement on future projects?

Progress toward water quality goals may be assessed by modeling the changes made within a watershed, i.e. the benefits expected from stormwater treatment processes implemented, the number of septic to sewer conversions made and/or various source controls promoted. For example, jurisdictions that drain to waterbodies where BMAPs are being implemented must calculate their progress toward target water

quality goals every five years. However, it is difficult to obtain sufficient water quality data to fully describe changes within a watershed and confirm modeled results in the short term. Extensive data collection over multiple seasons might be necessary to develop an accurate picture, and it would be very difficult to fully understand the relative contributions of different types of projects. Moreover, it may take years for legacy nutrients present in soil and groundwater to move through and be dissipated in the estuaries, and longer still for some aquatic habitats to recover. Still, imperfect or incomplete data can show trends, and reasonable estimates can be made of progress. Models can also be calibrated and updated over time, and measures being implemented to reduce pollutants may need reassessment.

11.1.2. Persistent impairment

Nutrients from Lake Okeechobee contribute to poor water in the St. Lucie estuary (SLE). At present, the water discharged from Lake Okeechobee to the SLE averages less than 40% of the total freshwater inflow to SLE annually, but it has varied considerably (around 10% in a dry month to more than 75% after heavy rainfall). In 2018, the U.S. Army Corps of Engineers projected that completion of the Central Everglades Planning Project, which includes the construction of a 240,000 acre-feet reservoir (A-2), a 6,500 acre stormwater treatment area, and various improvements to the conveyance system, would reduce the volume of water discharged to the northern estuaries by 55%.¹⁴⁷ This reduction in fresh water would be significant and beneficial to aquatic life in the estuary as well as lessening nutrient loads. But these projects should not be expected to completely solve water quality problems in the SLE, and they will not solve problems in other estuaries to the south.

11.2. Recommended Next Steps

Just as there are multiple causes of water degradation, there must be multiple solutions to reverse it. Many are being implemented in varying degrees, but continued efforts and additional actions are recommended. Below are the recommended next steps for broader implementation of LID and GI.

11.2.1. Continue pollutant reduction and promote LID and GI

- **Early planning for LID/GI** – Stormwater management and environmental protection should be integrated into the earliest phases of planning for urban development and redevelopment. Although new construction must already meet standards for stormwater and wastewater treatment, increasingly employing LID planning principles and site design would provide additional benefits.
- **Retrofit opportunities** – As most land in the region has been developed, most opportunities for using LID/GI will come from retrofitting in existing developments. Walls and roofs can become green spaces; adding density through building vertically can free additional land for GI and public spaces.
- **Provide incentives** – Incentives from local governments are needed to encourage LID/GI as well as a willingness by engineers and designers to take on the extra (initial) effort to design and

¹⁴⁷ U.S. Army Corps of Engineers & Central Everglades Planning Project. (2018). *Central Everglades planning project post authorization change report, feasibility study and draft environmental impact statement* (p. 333). Central Everglades Planning Project. Retrieved from https://www.sfwmd.gov/sites/default/files/documents/cepp_pacr_main_report.pdf

permit these projects. Programs to provide incentives for onsite stormwater retention on private properties have had favorable results in other cities.

- **Build demonstration LID/GI** – Demonstration projects and educational opportunities for planners and development professionals can accelerate a shift from conventional approaches to stormwater management to LID/GI. School grounds are good locations for demonstration projects; in some cases, students may participate in planning, design, construction, and maintenance of SCMs.
- **Coordinate regionally** – Communication and coordination between regional municipalities is a key ingredient to facilitate LID/GI promotion and integration. Budgets and energy are limited, so efforts should not be duplicated—share ideas and experience with what works. Discussions with other municipalities that have significant experience implementing LID may be helpful in avoiding problems and maximizing the impact of local programs.
- **Replace at-risk OSTDs** – Older OSTD systems (constructed before the current standards) and those at risk from sea level rise should be discontinued or enhanced to provide an advanced onsite treatment system, following the recommendations of the Florida Onsite Sewage Nitrogen Reduction Strategies Study and the Florida Department of Health.
- **Maintenance is paramount** – Ensure that comprehensive maintenance plans for LID SCMs are developed and that training is provided as needed to local government personnel, landscaping maintenance companies, and others responsible for their continued operation. Training should include background on the purpose for the SCM and its function as well as specifics of maintenance procedures.
- **Revise policies as warranted by research** – More research is needed into the effects of various chemicals used in urban areas on aquatic life and action taken to replace, control, or treat those that are identified as harmful. This includes common substances in pesticides and asphalt sealants to pharmaceuticals and sunscreens.

11.2.2. Local government policy and regulations

- **Review and update ordinances and policies** – Regulations and policies at all levels of government should continue to be adapted to reflect the importance of sustaining a healthy environment and improving water quality using a mix of regulations and incentives. Look for any codes that act as a barrier to LID, such as a requirement for curb and gutter or large building setbacks in residential areas. Zoning and subdivision regulations, parking lot requirements, and standard road and building specifications and detail drawings may have outdated requirements, so be sure to look for new opportunities to encourage LID design principles.
- **Involve local building community** – Vet LID/GI design methods with builders, developers, and others in the development community and work with the SFWMD to specify design criteria and award credits.
- **Measure, analyze and document results** – Document the effectiveness of SCMs over a range of locations and conditions to improve design specifications and increase confidence in their use.

- **Native plants** – Encourage or require greater use of native plants that require less irrigation, fertilizer and pesticide use. This must be combined with public education so that property owners know how to reduce their water use and landscape chemical inputs.
- **Cost estimates** – Estimates of life-cycle costs of SCMs would similarly increase LID acceptance and assist in making the most appropriate selections. Create a database of regional construction, operation and maintenance costs for LID/GI projects.
- **Innovative financing** – Options can be explored to subsidize costs of public projects and incentives. Stormwater utility fees, permit trading programs, grant program funding, environmental municipal bonds, revolving water funds and other private sector financing have been used to fund LID/GI and nutrient reduction programs.
- **Planning horizon** – Include climate change impacts in medium and long-term planning at the local and regional scale to mitigate flooding and potential for water contamination due to sea level rise and other aspects of climate change. Consider easements and outfall elevations that will be needed in the future.

11.2.3. Education and public involvement

- **Connect the dots** – Public education efforts must continue to expand understanding of the connections between water quality and our land use and personal choices. Focus on why LID/GI matter – teach their benefits to all Floridians.
- **Explain the purpose and function of LID/GI** – Landscape messages should show that LID landscapes are functional, not just nice to look at, and they must be maintained. Native plants thrive most easily, and pests can be controlled with integrated pest management methods. Trees in particular offer many benefits and should be protected. Also include information in public education to address the correct disposal of grass clippings to remove a common source of nutrients into the stormwater system.
- **Community-wide participation** – Encourage public involvement (individuals and organizations) in developing and implementing policies and programs related to land use, habitat preservation, stormwater and pollutant management, and climate change. A coalition of stakeholders to address specific issues will bring a range of perspectives, increasing the public’s understanding and ultimate success of the program.
- **Toxic/hazardous materials source controls** – Continue public education programs on responsible disposal of household chemical wastes and promote facilities that accept used motor oil and other toxic or hazardous wastes. Further research into the use of local, inexpensive materials for soil amendments in bioretention and filtration media could increase their use and improve pollutant removals.