

# YOUR PETROLEUM STORAGE TANK FACILITY INSPECTION GUIDE

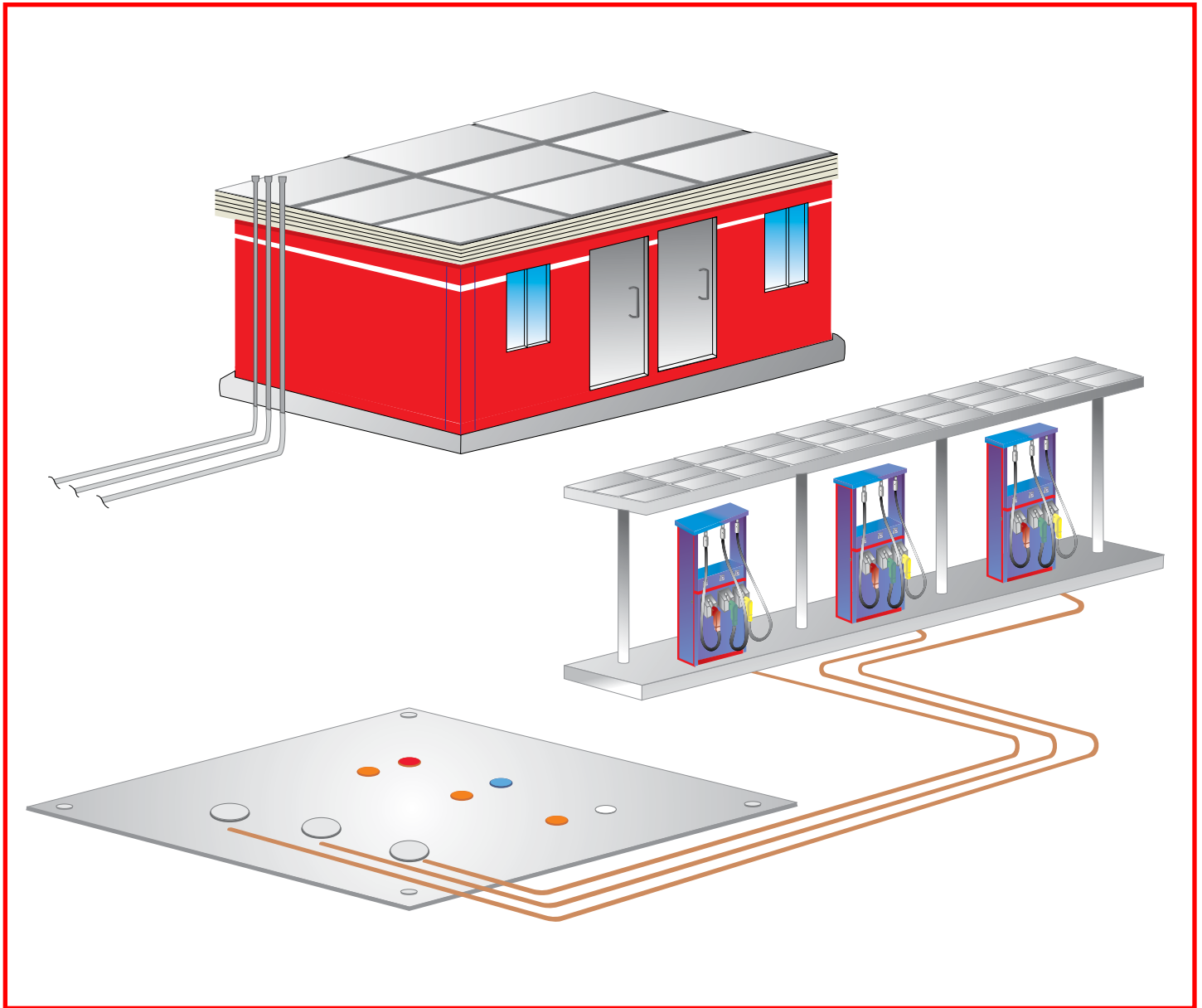

**HOW WELL DO YOU KNOW YOUR  
PETROLEUM STORAGE AND  
DISTRIBUTION SYSTEM?**

**This handbook is provided as a general guide.**

For specific regulation requirements refer to the underground and aboveground storage tank system rules (Chapter 62-761 and Chapter 62-762, Florida Administrative Code) which are located at the district and county offices, and at the storage tank program web site ([www.dep.state.fl.us/waste/categories/tanks/default.htm](http://www.dep.state.fl.us/waste/categories/tanks/default.htm)).

**TABLE OF CONTENTS**

- A. Records and Certificates to be Kept on File ..... 1
- B. Internal Leak Detection Systems ..... 2
- C. External Leak Detection — Groundwater and Vapor Monitoring Wells..... 3
- D. Dispenser Assembly and Components ..... 4
- E. Dispenser Hose Nozzles, Pressure Vent Valves and Vent Pipes ..... 5
- F. Fill Areas Assembly with Color Coded Covers..... 6
- G. Sump Pump and Containment Assembly ..... 7
- H. Double Wall Storage Tanks ..... 8
- I. Double Wall Piping..... 10
- J. Aboveground Fuel Dispensing System with Dispenser ..... 11
- K. Fuel Dispensing System Assembly and Exploded View of  
Commonly Used Components..... 12
- L. Aboveground Fuel Storage Tanks Installation..... 14
- M. Specifications for Aboveground Storage Secondary Containment Construction..... 15
- N. Aboveground Emergency Generator Fuel Tank Storage Installation ..... 16
- O. Fuel Dispensing System and Aboveground Visual Inspection Check Sheets..... 17



**Handbook Guide For Petroleum Storage Tank Systems**

**Prepared by**

**Broward County Environmental Protection Department  
Pollution Prevention and Remediation Division**

**for the**

**Florida Department of Environmental Protection (FDEP)  
Division of Waste Management  
Bureau of Petroleum Storage Systems**

Inclusion of specific equipment brands within this document is intended for information purposes only and does not constitute endorsement of these products.

For a list of FDEP approved equipment, see:

<http://www.dep.state.fl.us/waste/categories/tanks/pages/equip.htm>

Comments herein on Stage I and II Vapor Recovery Systems are not applicable to all counties.

## A. RECORDS AND CERTIFICATES TO BE KEPT ON FILE

### IT'S GOOD FOR YOUR BUSINESS AND IT SAVES INSPECTION TIME!

Remember that the law requires you to keep certain records about your storage tank system. Inspectors will ask to see these records.

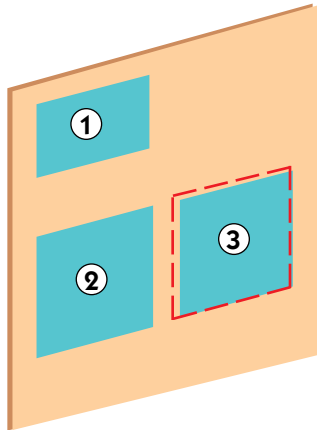

Figure 1

### DISPLAY THESE DOCUMENTS WHERE EVERYONE CAN SEE THEM

1. The current FDEP Registration Placard. Remember to check the placard for the proper address.
2. Current certification of financial responsibility.
3. Current local government permit, if applicable.

### YOU DON'T HAVE TO DISPLAY THESE RECORDS, BUT DO KEEP THEM ON FILE

#### Keep these Records for At Least Two Years

- ✓ Storage tank fuel inventory, including tank water level.
- ✓ Monthly release detection results.
- ✓ Electronic release detection equipment monthly function checks.
- ✓ Monthly maintenance visual examinations and results.
- ✓ The presence of regulated substance's odor, sheen or free product.
- ✓ A copy of all test data results. Tightness, pressure and integrity tests.
- ✓ Repair, operation and maintenance records.
- ✓ Certificate of Financial Responsibility.

#### Keep these Records for the Life of the Storage Tank System

- ✓ Manufacturer's performance claims for your leak detection system.
- ✓ Dates of upgrades or replacement of the storage tank systems.
- ✓ Results of internal inspections.
- ✓ Installation, maintenance, inspections and testing of cathodic protection systems.
- ✓ Storage system installations, replacements and upgrades.
- ✓ Closure assessment report if facility is still operating.
- ✓ Written Release Detection Response Level information.



Figure 2

## B. INTERNAL LEAK DETECTION SYSTEMS

All facilities must have internal or external release detection equipment for their storage tank systems. (Please refer to Chapter 62-761 and Chapter 62-762, Florida Administrative Code, for more information.)

Commonly used continuous automatic leak detector systems & fuel dip stick. Remember to check these items monthly and record the results.

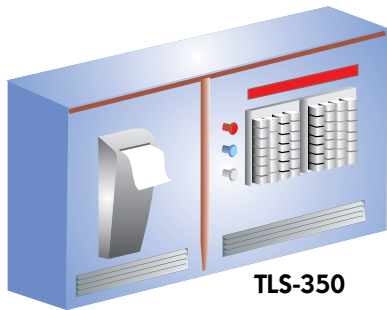

Figure 1

TLS-350



Figure 2

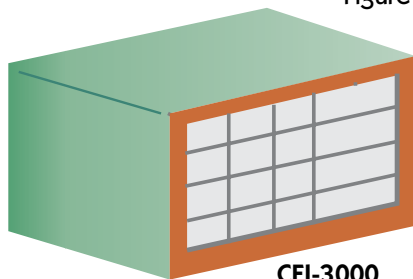

Figure 3

CEI-3000

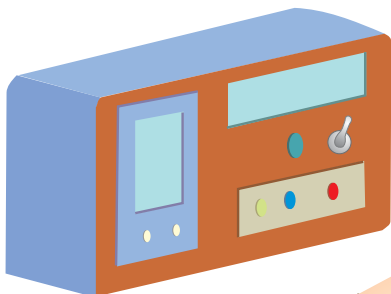

Figure 4

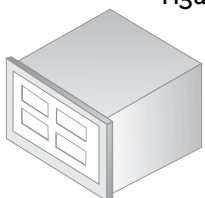
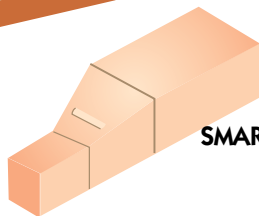

Figure 5



SMART CEI

Figure 6



### 1. Automatic Tank Gauges

#### Figures 1, 3, and 5

TLS-350, CEI-3000, VEEDER-ROOT and SMART CEI, Continuous Automatic Leak Detector System will give you one or more readings that may include inventory records, line leak monitoring, UST monitoring, test history, and UST water level. For a list of FDEP approved equipment, see: <http://www.dep.state.fl.us/waste/categories/tanks/pages/equip.htm> or call your local Petroleum Storage Tank program.

#### Figures 2 and 4

ILS-350 and TMS-3000, respectively. These systems will provide in-line leak detection only.

### 2. SIR

A release detection method for UST's where statistical analysis of inventory, delivery, and dispensing data is used to identify possible leaks.

### 3. Interstitial Monitoring

Typically associated with double wall UST's and underground piping systems, product leaked from the primary containment is directed toward an interstitial monitor located in the space between the primary and secondary containment walls.

#### General Concerns About Leak Detection

- ✓ Inspect the system at least monthly and record the inspection results.
- ✓ Electronic or visual interstitial monitoring must be conducted for all double-walled UST's and underground piping.
- ✓ Inventory reconciliation must be conducted monthly on single walled UST's.
- ✓ For those systems without inventory reporting features, inventory must be checked manually using a dip stick (Figure 6).
- ✓ When using a stick, check its condition. Wear and tear on the stick, especially at the ends, can result in inventory discrepancies.
- ✓ Make sure the stick is being used right side up.

## C. EXTERNAL RELEASE DETECTION - GROUNDWATER AND VAPOR MONITORING WELLS

If you have groundwater or vapor monitoring wells, they must be checked monthly and the results recorded. Inspectors will always look for these results.

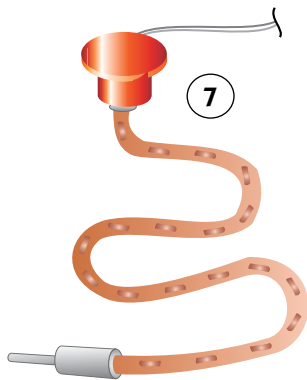
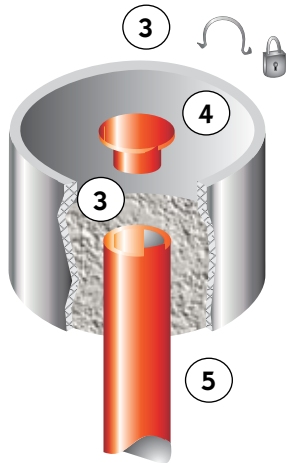
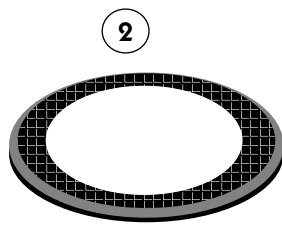
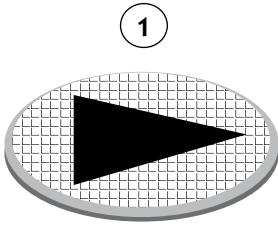

- 1. Compliance Monitoring Well Cover**  
(black triangle on white cover).
- 2. Redesignated Assessment Well Cover**  
(white circles on black cover).
- 3. Monitoring Well Containment with Grouting at Bottom**  
Routinely check grouting with a screwdriver or equivalent to ensure the grouting is intact. (Solid grouting is necessary to prevent surface runoff or spills from entering the soil through the well containment area.)
- 4. Monitoring Well Cap with Lock**  
Well cap must be kept locked or secured with lock or clips. Lock keys must be available on-site. The cap must be watertight.
- 5. Monitoring Well Pipe**  
This pipe must be a minimum of at least one inch above the surface of the grouting (to help prevent standing contaminated liquid from entering into the well when the cap is removed).
- 6. Monitoring Well Acrylic Bailer with Cord**  
Keep the bailer and cord clean. When sampling wells, care should be taken if one well has signs of contamination (otherwise, wells will be cross contaminated). Bailers should be cleaned between each well sampling. A disposable bailer may be used.
- 7. Monitoring Well Probe**  
Check the integrity of wires and connections. (If applicable)
- 8. Monitoring Well Use at Previously Contaminated Sites**  
make sure that the monitoring system used is approved by the state as being approved to detect new releases above background.

## D. DISPENSER ASSEMBLY AND COMPONENTS

On a monthly basis, visually inspect the dispenser and assembly for any problems. Record these monthly checks in a log to demonstrate that the inspections are being completed. Routine inspection will identify problems early, before they develop into serious costs, and will ensure the equipment works to reduce emissions and leaks.

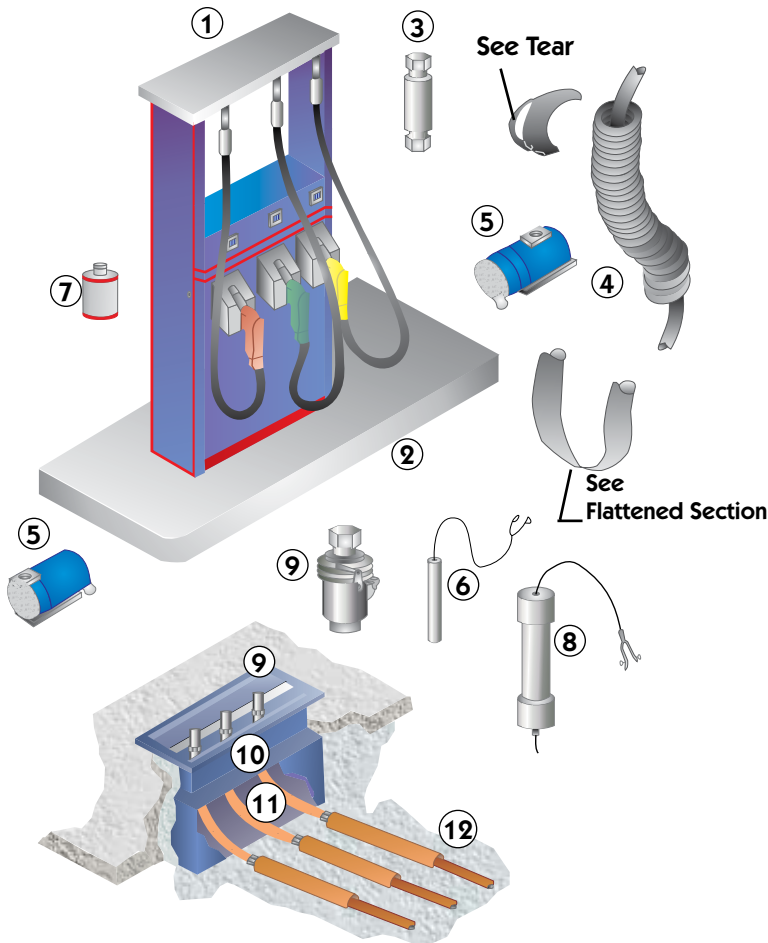

### 1. Dispenser Assembly

Covers should be lockable and keys should be available for monthly inspection. When looking inside the dispenser, check the pipe fittings, emergency shut off (or shear) valves (make sure you have one on each fuel line), fuel filters, dispenser liners or secondary containment, leak detection sensors, and cathodic protection anodes. (Your dispenser may not need all these items.)

### 2. Dispenser Island

Keep free from open cans or containers to avoid costly accidents.

### 3. Stage Two Vapor Recovery Breakaway Valve (If applicable)

Check for leaks at connections.

### 4. Dispenser Hoses

For coaxial hoses (if applicable), check for flattened areas, especially at the loop section. Also look for any cuts or tears in the hoses.

### 5. Vacuum Pumps

Listen to hear if both pumps are working (pumps may also be mounted inside dispenser roof).

### 6. Continuous Automatic Leak Detection Sensor (If applicable)

Check connections. Check height of sensor from secondary containment bottom. The leak detection system should alarm when there is a fuel leak or an excessive amount of liquid in the dispenser sump.

### 7. Fuel Filter

Check filter connection and condition on each fuel line. Change if necessary.

### 8. Cathodic Protection Systems Anode

Check wire connection to anode and connection to steel pipe. (If applicable)

### 9. Emergency Shut Off or Shear Valve

Check valve lever and connection to bracket, as shown. (There should be one shear valve for each fuel line. If applicable)

### 10. Dispenser Piping Sump Secondary Containment

Check for cracks and for excessive amount of liquid in containment.

Liquid must be pumped out and safely disposed of.

### 11. Flex Pipe Connection

Check for tears or breaks. (May not be accessible.)

### 12. Primary and Secondary Containment Pipes

Pipes should slope back to storage tanks to ensure that, in the case of any line break, product will flow back to the storage tanks. (It is unlikely pipes will be visible for inspection.)

## E. DISPENSER HOSE NOZZLES, PRESSURE VENT VALVES AND VENT PIPES

### NOZZLES

Some commonly used nozzles for Stage II vapor recovery systems (if applicable). Check these regularly for defects.

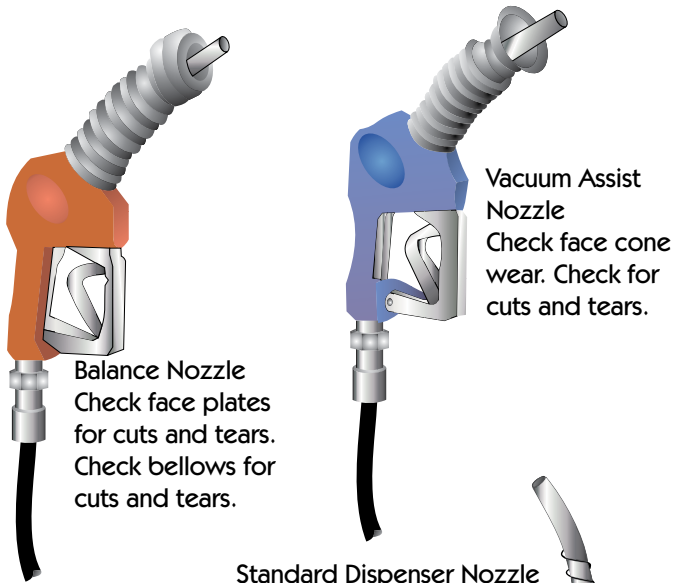

Standard Dispenser Nozzle  
(Not applicable for Stage II Vapor Recovery System)  
1. Check hose adapter for tight fit.  
2. Standard Dispenser Hose.

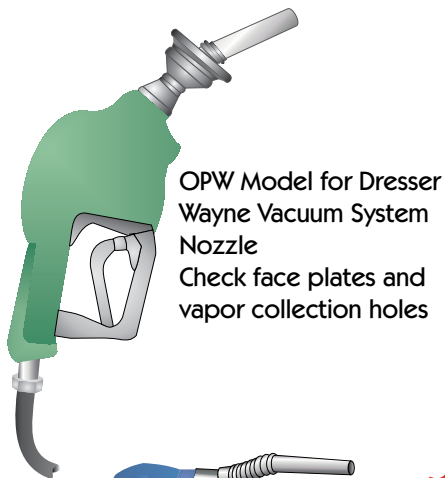

### UST VENT LINES

Vent lines are important because they allow pressure within the tank to equalize when product is removed from the tank. Note: vent lines should extend a minimum of twelve feet above ground level. (Vent lines are not regulated under Rule 62-761, F. A. C.)

#### Figure 1. Pressure Vent Valve.

This valve must be in place at all times. This also prevents debris from falling into the tank.

#### Figure 2. Storage Tank System Vent Lines.

Each vent line represents one underground tank. A pressure vent valve must be in place for each vent line.

#### Figure 3. Vent Line Manifold.

This type of assembly requires only one pressure vent valve.

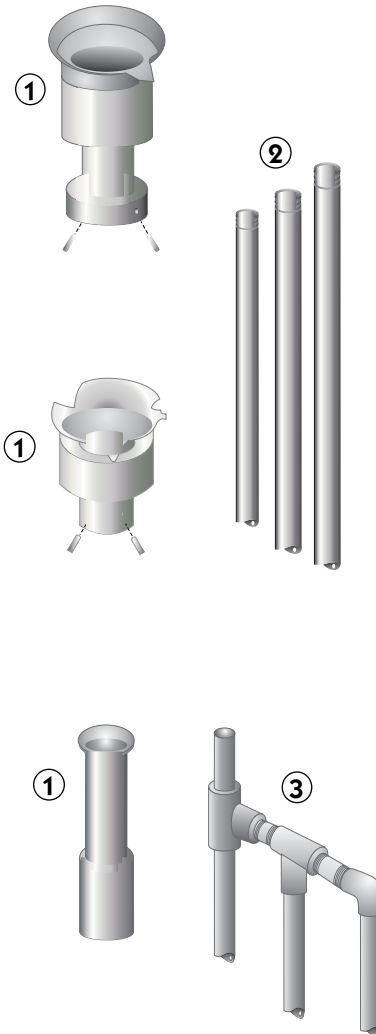

## F. FILL AREAS ASSEMBLY WITH COLOR-CODED COVERS

### FILL AREAS

Fill areas are the connections where UST's are filled, typically by a gravity drop through a vertical or remote fill pipe. These apply only to AST's where the fill is at grade and the AST is below grade. Note that special colorization is required for fill covers. This helps prevent accidental filling of the wrong fuel into the wrong tank. Coding should be both on the cover and a second, non-removable portion of the fill. This will prevent problems associated with accidental switching of covers. Visually inspect all these components monthly.

1. **Hi-Grade Fill Cover.** Red with a white cross.
2. **Mid-Grade Fill Cover.** Blue with a white cross.
3. **Low-Grade Fill Cover.** White with a black cross.
4. **Low Sulfur Diesel Fill Cover.** Yellow.
5. **Used Oil Cover.** A blue square.
6. **Hi-Sulfur Fill Cover.** Yellow, with a blue dash.
7. **Stage I Dry Break Cover.** Orange.
8. **Fill Containment.**  
(Spill Protection usually a "Spill Bucket")  
Check for liquid accumulation and interior seam integrity.
9. **Fill Pipe with Cap.**  
Cap should be lockable and watertight.
10. **Release Valve.**  
This must only be used to release fuel from the fill containment back into the tank (typically used during refueling of the tank). Any other liquids that accumulated in this area should be removed manually and must be safely disposed of.
11. **Stage I Dry Break Poppet Cap with Gasket.**  
Ensure cap fits tightly. (If applicable)
12. **Stage I Dry Break Poppet. (If applicable)**  
Press spring loaded valve in center for spring compression reaction. Poppet caps must be in place at all time except when storage tanks are being fueled.
13. **Spill Protection/Containment.** Check containment integrity for cracks or rust, especially around the interior seams. Hydrotest annually for integrity.
14. **Overfill Devices.** These devices are designed to prevent overfilling of the storage tank. **Do not allow these devices to be disabled.**

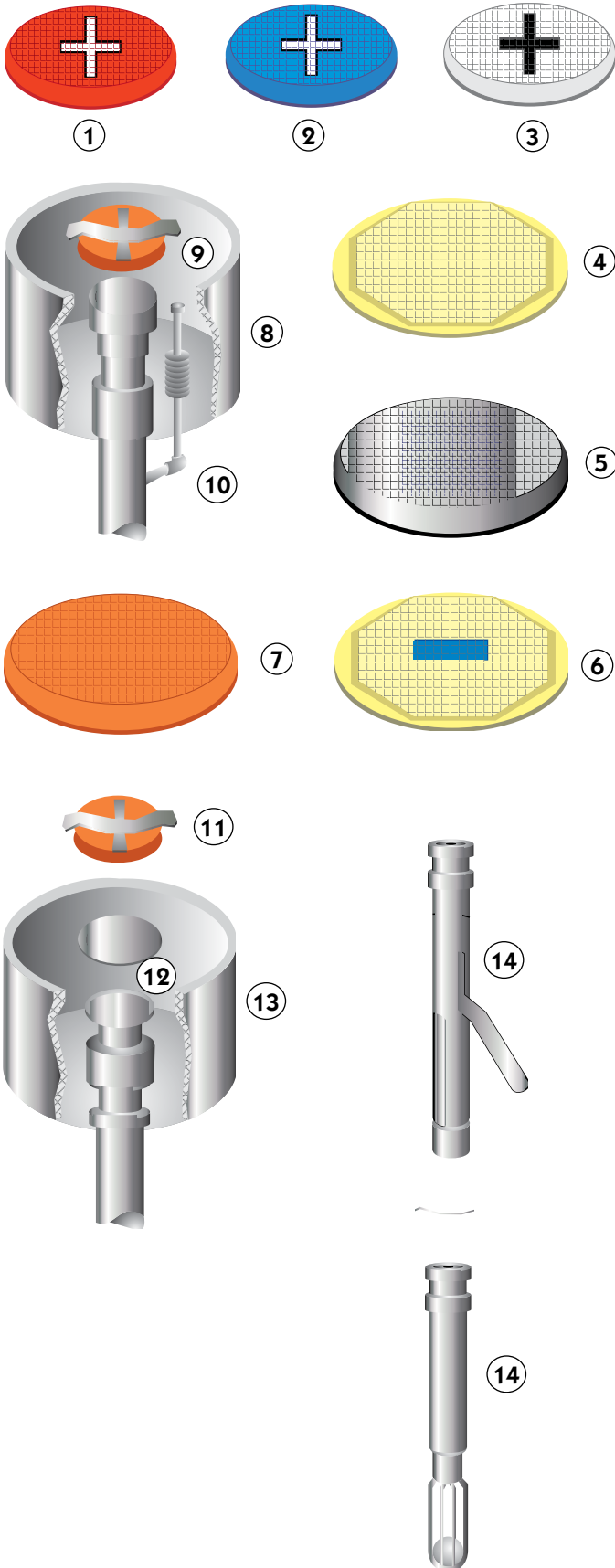



## G. SUMP PUMP AND CONTAINMENT ASSEMBLY

Complete a visual inspection of sumps monthly unless equipped with sump sensor.  
If so, periodic visual inspection is recommended.

The sump is the area housing the submersible turbine pump.

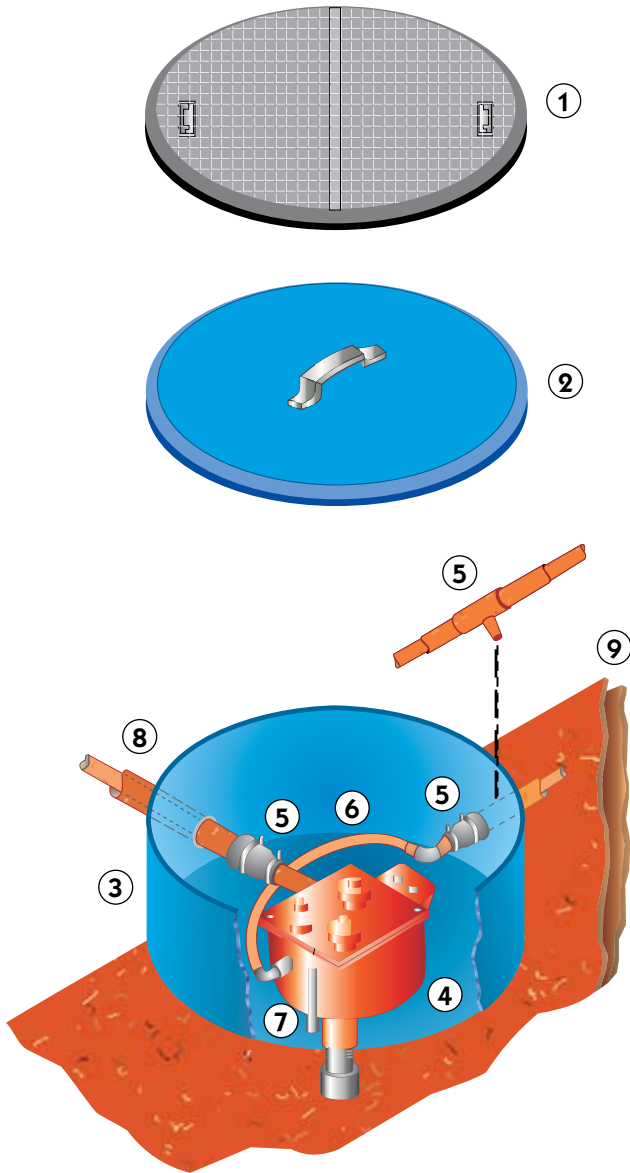

### 1. Sump Pump Access Cover

Remove cover with caution to avoid dropping the cover onto the sump containment cover, which may result in damages.

### 2. Sump Containment Cover

This must be fitted tightly to minimize the intrusion of liquid into the sump containment, which can result in an accumulation of sufficient quantity to trip the leak detection system alarm.

### 3. Sump Containment

Check for cracks or holes. Check after rain events to confirm the sump cover is water tight.

### 4. Fuel Sump Pump Assembly

Check all connections for sweating or leaks.

### 5. Test Boots

Test Boots or Reducing Tees may be used to pressure test outer wall piping. The boots must be pulled back from the secondary lines, and the reducing tee test port must be unplugged after lines have been tested. If this is not done, any leakage into the outer wall piping will not flow into the sump and alert you that there is a leak in the primary piping.

### 6. Flex Connectors

**a. Flexpipe** - Check connections for elongation, swelling, materials degradation, ballooning, leaks, holes.

**b. Semi-rigid** - Check connections for leaks, elongation, swelling.

**c. Rigid Pipe** - Check connections for cracks, leaks.

### 7. Continuous Automatic Leak Detection System Sensor (If applicable)

Check connection and height from bottom of containment. There should be a maximum of about 2" inches from the sensor tip to the bottom of the sump containment.

### 8. Double Wall Pipes - see page 10.

### 9. Double Wall Tanks - see page 8-9.

## H. DOUBLE WALL UNDERGROUND STORAGE TANKS

The main component of the storage tank system.

By December 31, 2009, all **underground** storage tanks must be double walled or have some other type of secondary containment.

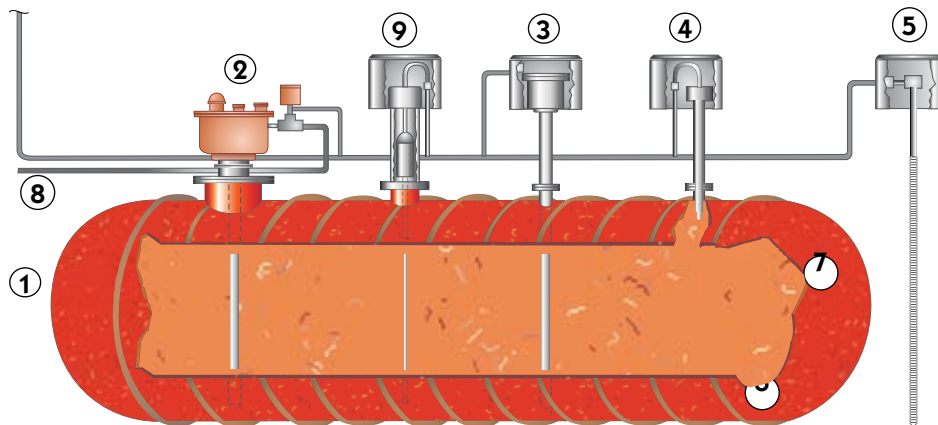

**Typical Tank with Components**

- |  |   |
|--|---|
| 1. Double wall fuel storage tank                               | 6. Continuous automatic leak detection sensor                     |
| 2. Piping submersible pump                                     | 7. Lead wire to continuous automatic leak detection control panel |
| 3. Fill pipe with spill containment                            | 8. Fuel line  |
| 4. Interstitial monitoring device                              | 9. Fuel sensor  |
| 5. Monitoring well with sensor and containment (If applicable) |   |

**Double Wall Fiberglass Tank with Factory Sealed Interstice using Vacuum Monitoring**

1. Outer wall
2. Polyethylene Mesh (creates interstitial space)
3. Inner wall
4. Vacuum line and gauge
5. Vacuum monitoring gauge
6. Fuel line
7. Vent line
8. Fill pipe
9. Stage One vapor recovery (If applicable)
10. Spill containment with cover
11. Submersible pump
12. Sump containment cover
13. Drop tube
14. Strike plate

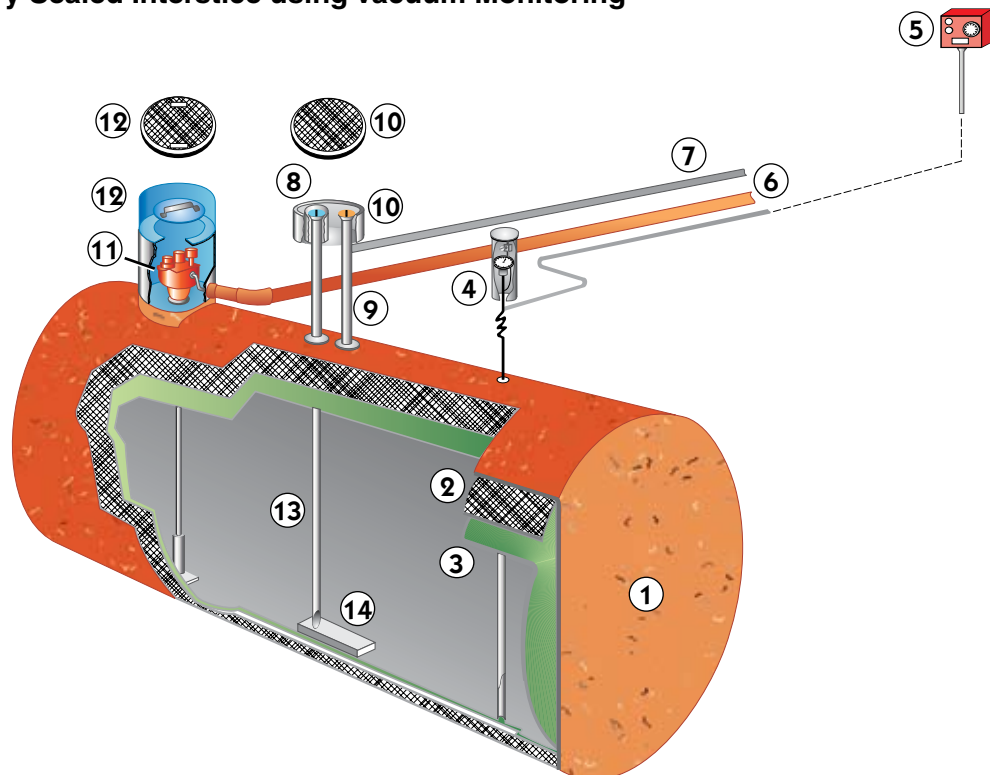

### Double Wall Steel Tank with Cathodic Protection

1. Piping sump
2. Leak detection
3. Submersible turbine pump
4. Double-wall as shown with Dielectric coating
5. Overfill protection (Ball valve type may also be used)
6. Spill containment and fill pipe
7. Stage One vapor recovery (if applicable)
8. Vent line fitting
9. Galvanic anode (Prevents corrosion)
10. Lifting lugs
11. Certified stamp

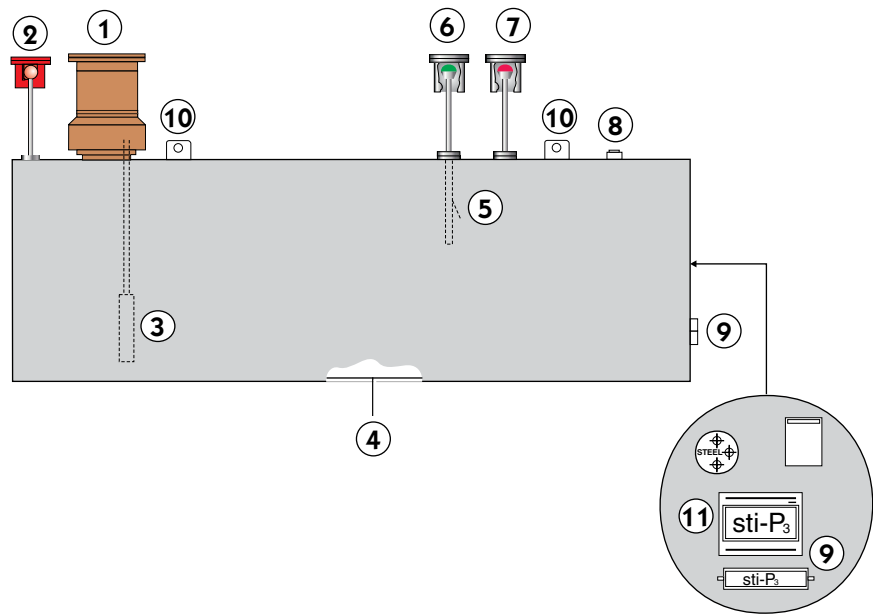

### Double Wall Tank - Composite (Fiberglass Coated Steel)

1. Primary tank
2. Fibre 360 interstitial structural layer
3. Fiberglass secondary containment
4. Accessway for sump
5. Lifting lugs as required
6. Monitoring openings - on tank centerline

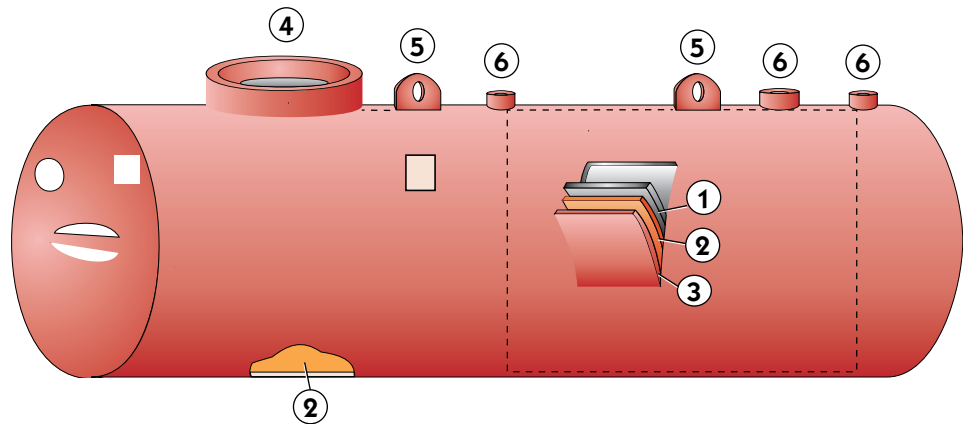

### Internal Secondary Containment

A rigid inner tank installed within a new or existing single-wall tank.

1. Existing rigid tank - Secondary containment
2. New rigid inner tank - parabeam
3. Drop tube
4. Strike plate
5. Spill containment
6. Supply line
7. Vent line
8. Piping sump and containment
9. Liquid collection sump
10. Liquid sight glass
11. Vacuum line
12. Vacuum line to vacuum and pump gauge
13. Interstitial space

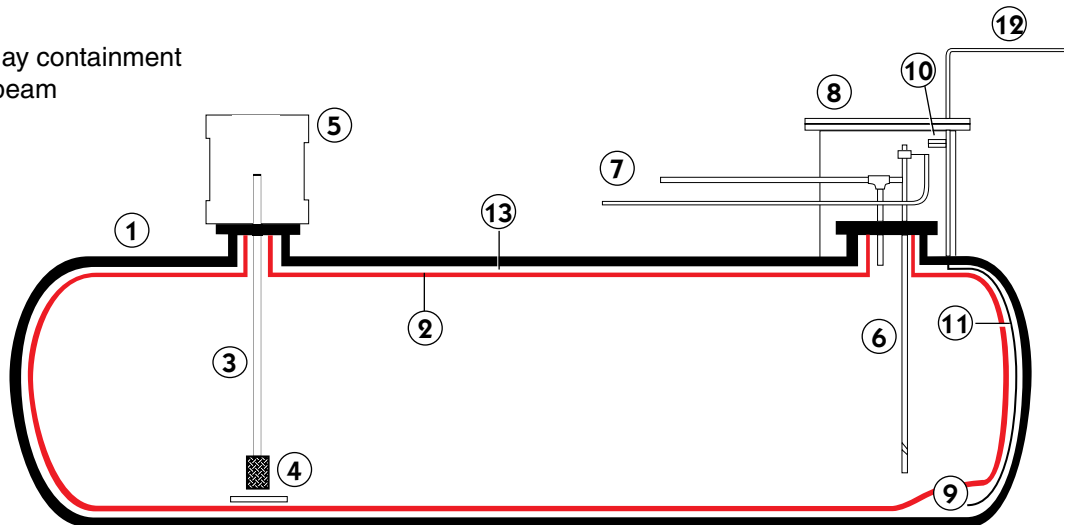

## I. DOUBLE WALL PIPING

For electronic leak detection systems, the TYPE of piping in a system will affect where the release detection sensor would normally be found. For a list of FDEP approved equipment, see:

<http://www.dep.state.fl.us/waste/categories/tanks/pages/equip.htm>

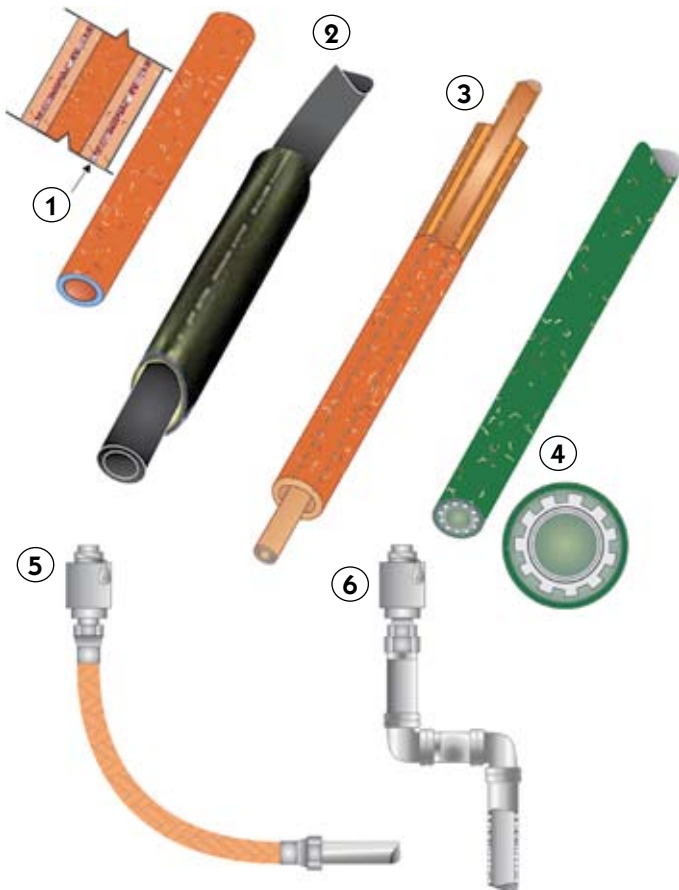

- 1. Double Wall Fiberglass Coaxial Pipe.**  
This piping has a 90% closed interstice with the remaining 10% of the space packed with very fine sand between the inner and outer walls. Release detection sensor should be placed in the piping sump.
- 2. Double Wall Semi-rigid with Interstitial Space.** On this piping, the release detection sensor is located inside the interstitial space.
- 3. Double Wall Fiberglass Pipe with Open Interstitial Space.** On this piping, the release detection sensor is located inside the interstitial space.
- 4. Double Wall Flexible Pipe with Closed Interstice.** Release detection sensor should be located in the piping sump.
- 5. Flex-Pipe with Emergency Shut-off Valve (Shear Valve).** This section of pipe is connected from dispenser piping assembly to storage tank piping assembly.
- 6. Swing Joint Steel Piping Assembly with Emergency Shut-off Valve (Shear Valve).** This section of pipe is connected from the dispenser piping assembly to the storage tank piping assembly. Cathodic protection should be installed on this section in the dispenser sump to avoid corrosion of pipes.

## J. ABOVEGROUND FUEL DISPENSING SYSTEM WITH DISPENSER

**Do a monthly visual inspection of your aboveground tanks and keep records of the inspection.**

By January 1, 2010 all **above ground** field-erected storage tanks must be upgraded with secondary containment. All shop-fabricated tanks must already have secondary containment.

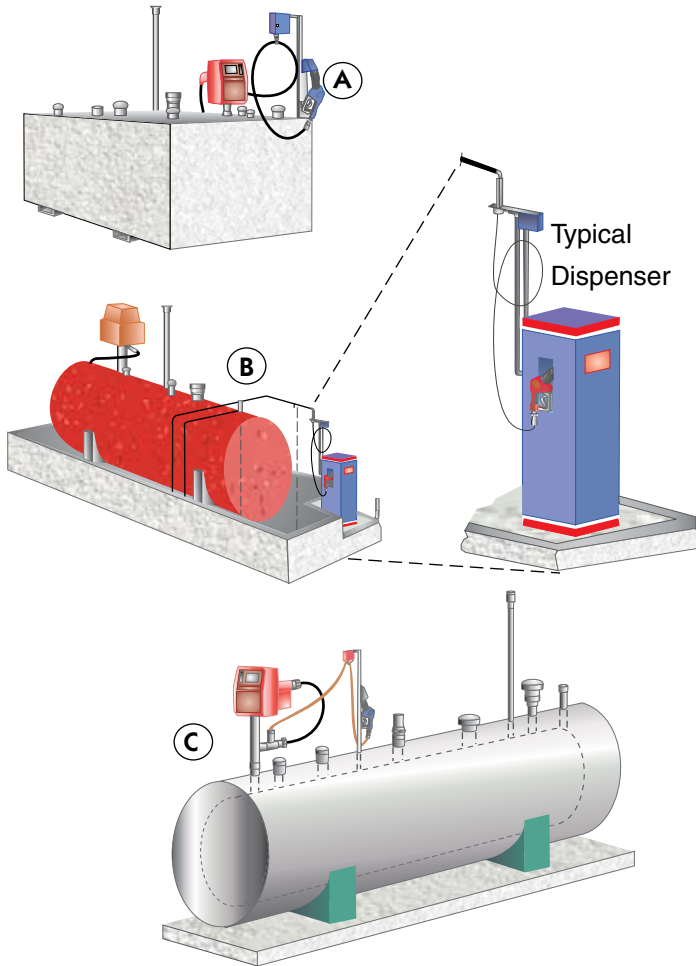

### A. Storage Tank and Dispenser

1. Check suction pump operation
2. Check vent lines for caps
3. Check fill cap-lock when not in use
4. Check hose retractor operation
5. Check dispenser hose for cracks or crimps
6. Check nozzle boot and faceplate
7. Check outer containment integrity

### B. Horizontal Installation of Storage Tank, and Dispenser

1. Check suction pump operation
2. Check vent line for cap
3. Check piping integrity
4. Check containment for liquid accumulation
5. Check containment for proper volume
6. Check tank coating integrity

### C. Horizontal Installation of Double Wall Steel Storage Tank, and Fuel Dispenser (without dike field containment)

1. Check suction pump operation
2. Check vent line for cap
3. Check piping integrity
4. Check containment for liquid accumulation
5. Check tank coating integrity

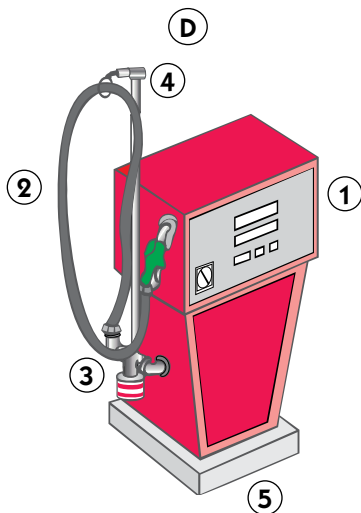

### D. Standard Fuel Dispenser (Dispenser liner not shown)

1. Dispenser
2. Dispenser hose
3. Fuel filter
4. Hose support
5. Concrete base

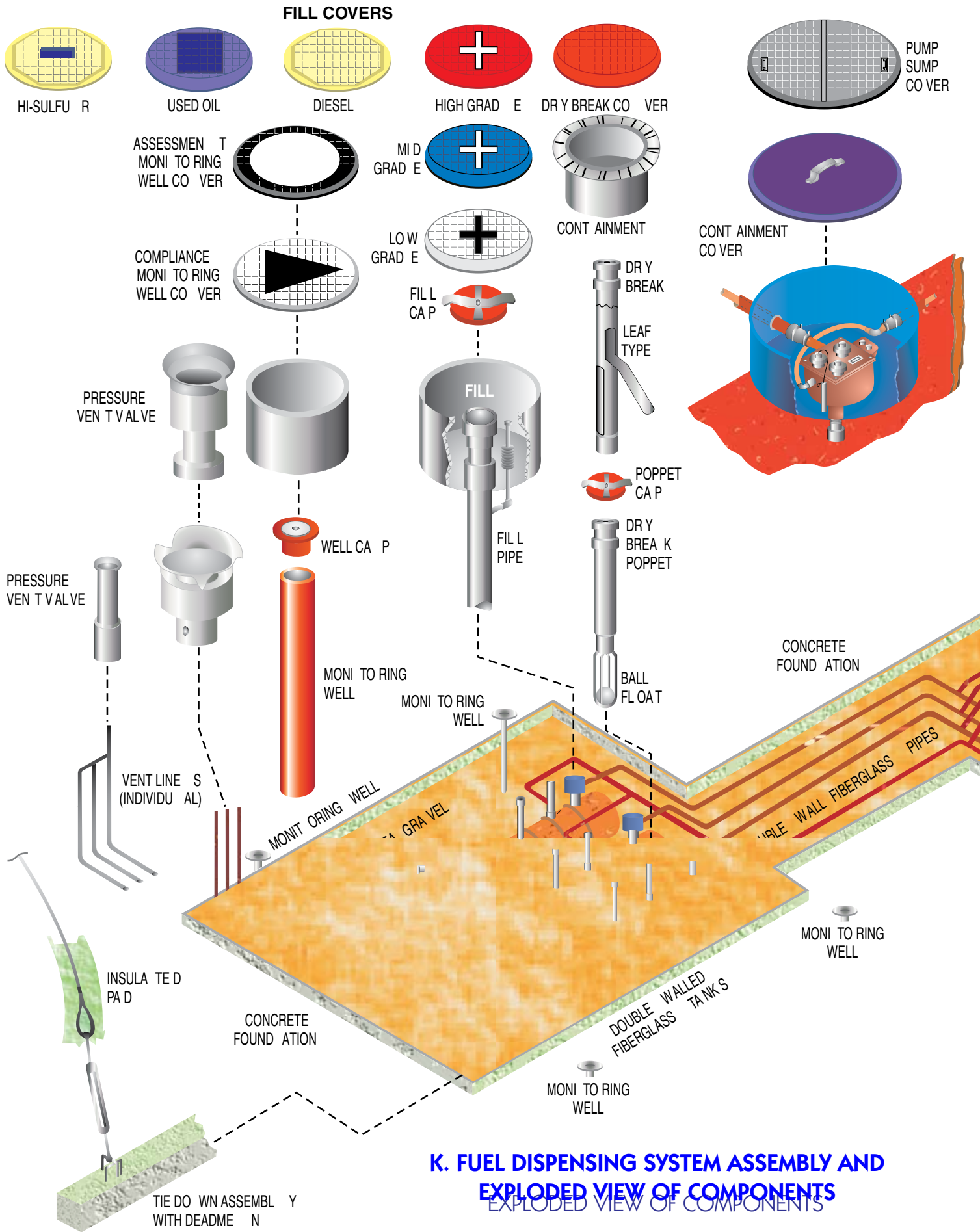

**K. FUEL DISPENSING SYSTEM ASSEMBLY AND EXPLODED VIEW OF COMPONENTS**

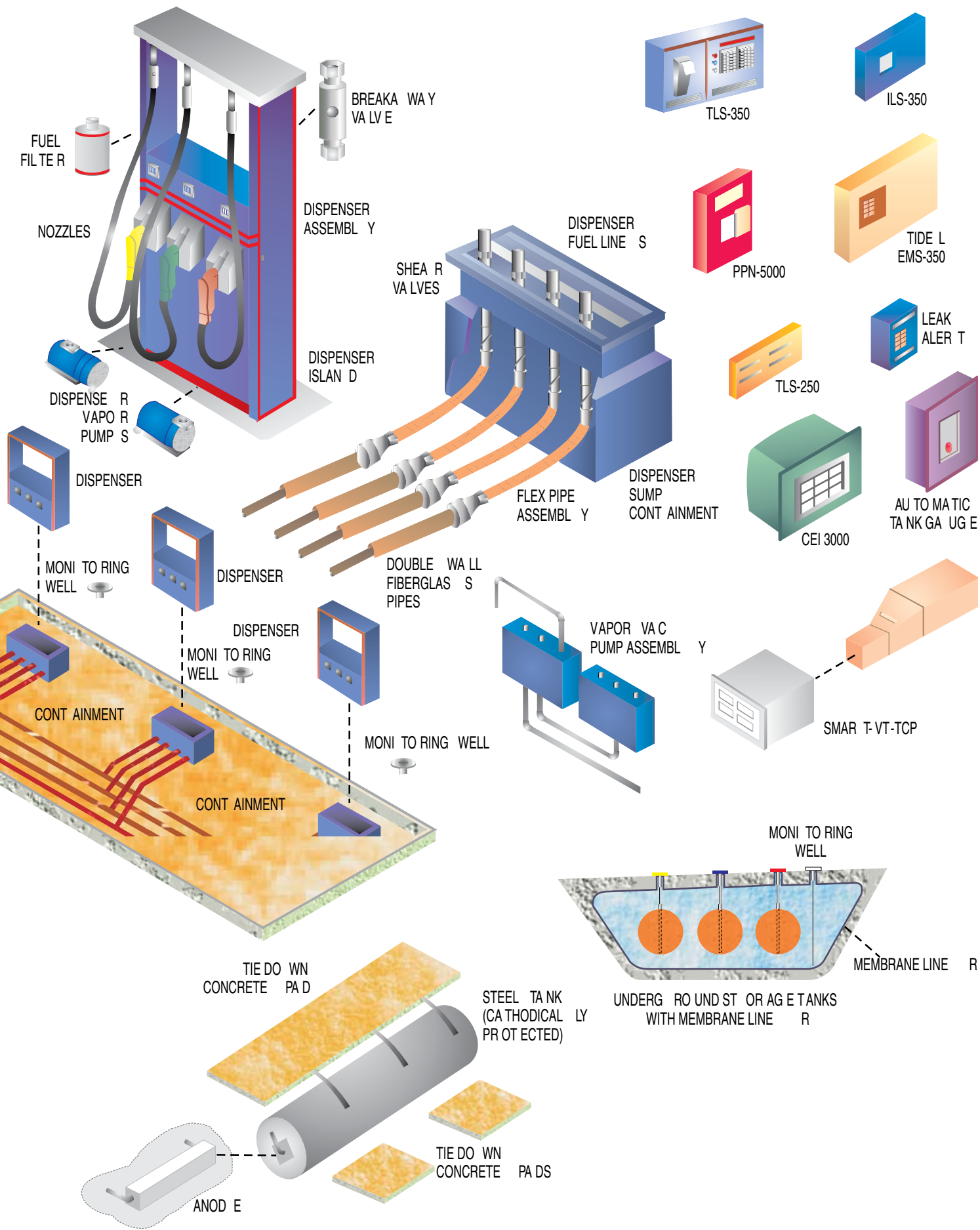

## L. ABOVEGROUND FUEL STORAGE TANK INSTALLATIONS

Do a visual inspection of your aboveground tanks monthly, and keep records of the inspection.

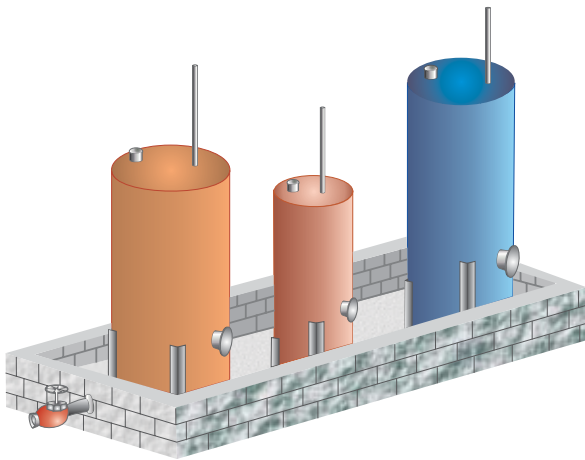

### Vertical Installation

#### **Aboveground Fuel Storage Tanks**

1. Check coating integrity
2. Check supports
3. Check secondary containment integrity
4. Inspect containment for liquid accumulation
5. Check drain valve for leak (must be lockable and secured when not in use)
6. Check vent lines to ensure caps are in place
7. Check for proper dimensions of containment volume

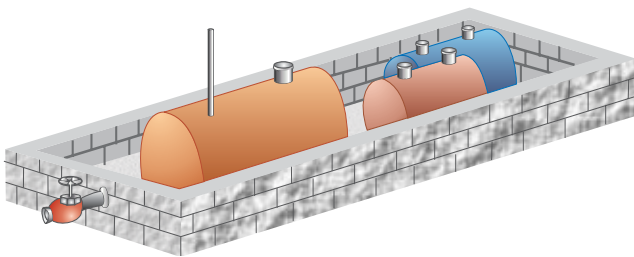

### Horizontal Installation

#### **Aboveground Fuel Storage Tank**

1. Check tank coating integrity
2. Check vent line for installation of vent caps
3. Check secondary containment integrity
4. Check for liquid accumulation
5. Check containment for proper volume
6. Check drain valve for leak (must be lockable and secured when not in use)
7. Check fill containment

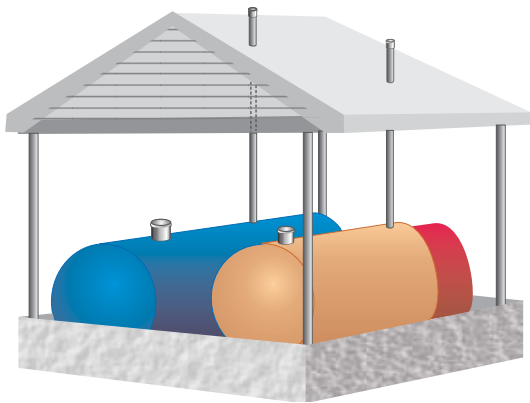

### Horizontal Installation

#### **Aboveground Fuel Storage Tank**

1. Check roof integrity
2. Check tank coating integrity
3. Check vent line for installation of vent caps
4. Check secondary containment integrity
5. Check for liquid accumulation
6. Check containment for proper volume



## M. SPECIFICATIONS FOR ABOVEGROUND STORAGE SECONDARY CONTAINMENT

TANK CAPACITY IN GALLONS	CONTAINMENT CAPACITY IN GALLONS	CONTAINMENT DIMENSIONS	PUMP PLATFORM	# OF SADDLE MOUNTS	SIZE AND # OF SKIDS	THICKNESS OF SIDES	THICKNESS OF BOTTOM
300	330	7'L x 4'W x 20"H	24"	2	2-4" I-BEAM	3/16"	3/16"
550	605	9'L x 5'W x 24"H	24"	2	2-4" I-BEAM	3/16"	3/16"
1,000	1,100	13'L x 5'W x 30"H	24"	2	2-4" I-BEAM	3/16"	3/16"
2,000	2,200	14'L x 7'W x 36"H	24"	2	2-6" I-BEAM	3/16"	3/16"
3,000	3,300	20'Lx7.5'Wx36"H	36"	3	3-6" I-BEAM	3/16"	1/4"
4,000	4,400	24'L x 8'W x 38"H	36"	3	3-6" I-BEAM	1/4"	1/4"
5,000	5,500	20'L x 8'W x 48"H	36"	3	3-6" I-BEAM	1/4"	1/4"
6,000	6,600	22'L x 8'W x 60"H	36"	3	3-6" I-BEAM	1/4"	1/4"
8,000	8,800	24'Lx10'Wx60"H	36"	3	3-8" I-BEAM	1/4"	1/4"
10,000	11,000	30'Lx10'Wx60"H	36"	3	3-8" I-BEAM	1/4"	1/4"
12,000	13,200	35'Lx10'Wx60"H	36"	3	3-8" I-BEAM	1/4"	1/4"

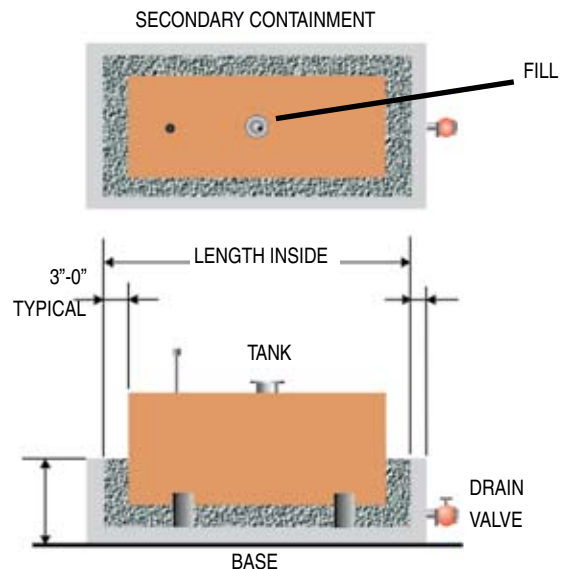
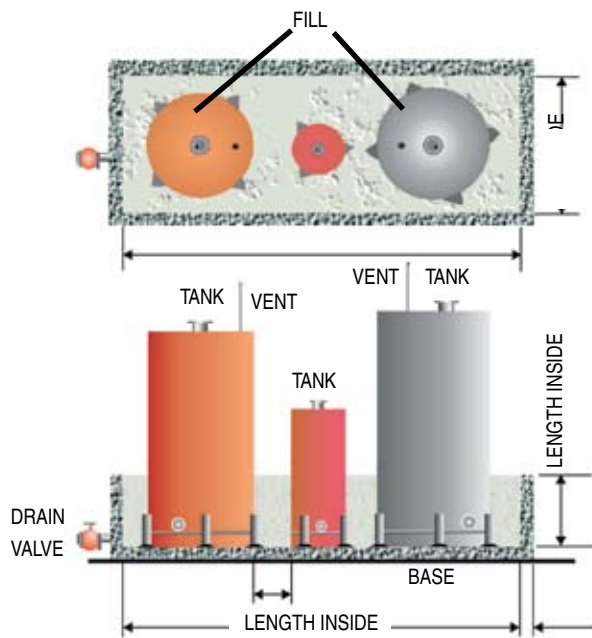
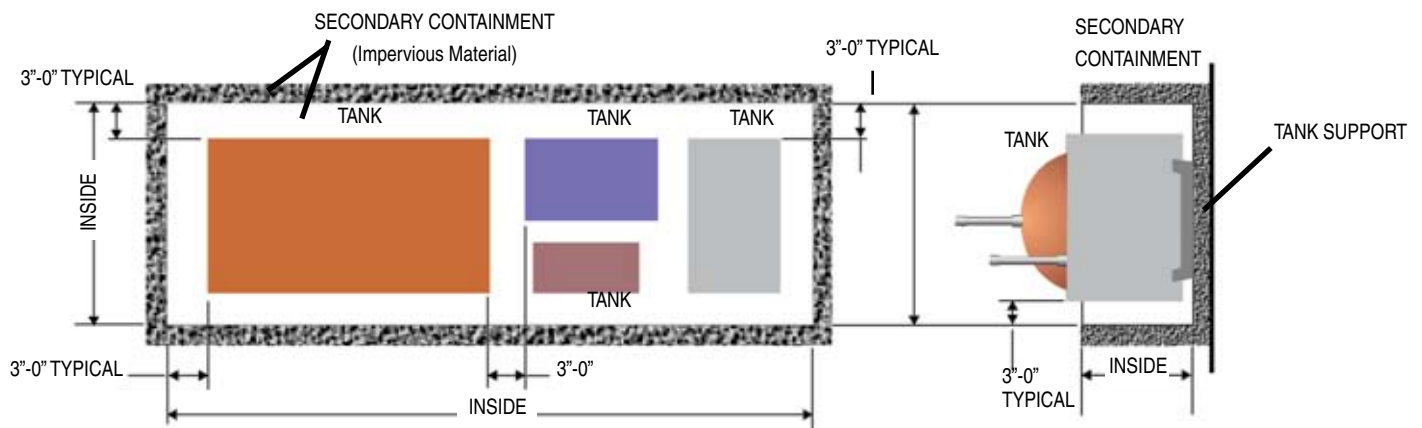

**Note:**

All dimensions for secondary containment must be measured inside the secondary containment.

Secondary containment must be made of impervious materials, be sealed and properly coated to prevent any

fuel or sweating on the ground area around the secondary containment.

All aboveground fuel storage tanks must identify (by name) the specific type of fuel that is being stored in each tank (e.g., diesel, gasoline, waste oil, etc.)

## N. ABOVEGROUND EMERGENCY GENERATOR FUEL STORAGE TANK INSTALLATION

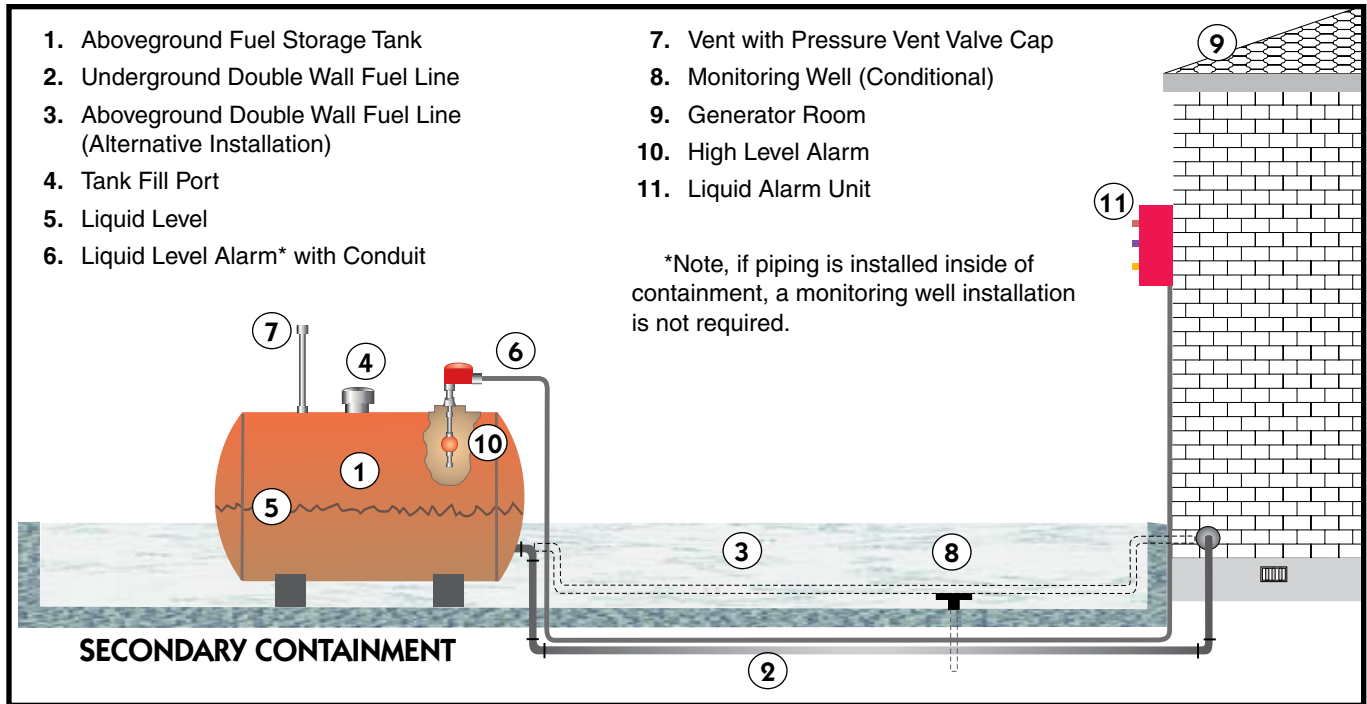

**Do a monthly visual inspection of your aboveground tanks and keep records of the inspection.**

**The following pages are model forms that can be used to help with facility storage tank management. They are optional and are not required by rule.**

**O. FUEL DISPENSING SYSTEM AND ABOVEGROUND VISUAL INSPECTION CHECK SHEETS**

**FUEL DISPENSING SYSTEM MONTHLY VISUAL INSPECTION CHECKLIST**

<b>SUBMERSIBLE PUMP/PIPING</b>	<b>DATE</b>	<b>RESULTS</b>	<b>REMARKS</b>
SECONDARY CONTAINMENT INTEGRITY			
CONTAINMENT COVER			
LIQUID SENSOR IN PLACE			
CORROSION PROTECTION ANODE WIRE IN PLACE			
SUBMERSIBLE PUMPS CONDITION			
PUMP & PIPING FREE FROM SOIL			
AMOUNT OF FUEL IN CONTAINMENT			
HYDROCARBON ODORS MODERATE OR STRONG			

<b>MONITORING WELLS</b>	<b>DATE</b>	<b>RESULTS</b>	<b>REMARKS</b>
MONITORING WELL CAPS IN PLACE WITH LOCK			
MONITORING WELL GROUTING INTEGRITY			
LIQUID ACCUMULATION REMOVAL			
MONITORING WELLS COVERS COLOR CODED			

## FUEL DISPENSING SYSTEM MONTHLY VISUAL INSPECTION CHECKLIST

FILL AREAS	DATE	RESULTS	REMARKS
FILL CONTAINMENT LIQUID ACCUMULATION REMOVAL			
FILL PIPE DROP TUBE IN PLACE			
FILL CAPS & GASKETS IN PLACE			
FILL CAPS LOCKED			
FUEL OVERFLOW RELIEF VALVE IN PLACE			
DRY BREAK POPPET INTEGRITY			
DRY BREAK POPPET CAP & GASKET IN PLACE			
LIQUID ACCUMULATION REMOVAL			
FILL COVERS COLOR CODED			

OTHER COMMENTS:

## FUEL DISPENSING SYSTEM MONTHLY VISUAL INSPECTION CHECKLIST

DISPENSER	DATE	RESULTS	REMARKS
DISPENSER LINER INTEGRITY			
LIQUID ACCUMULATION REMOVAL			
LIQUID SENSOR CONNECTION			
SHEAR VALVE IN PLACE			
SHEAR VALVE BRACKET CONNECTION			
FUEL FILTER INTEGRITY			
PIPE FITTING LEAKS			
CORROSION PROTECTION ANODE CONNECTION			
VAPOR PUMPS OPERATING			
PRESSURE VENT VALVE IN PLACE			

OTHER COMMENTS:

## UNDERGROUND STORAGE TANKS

### MONITORING WELL RECORD

EACH WELL WILL BE CHECKED AND RECORDED - **MONTHLY**

DATE							
WELL #1							
ODORS							
PRODUCT							
DATE							
WELL #2							
ODORS							
PRODUCT							
DATE							
WELL #3							
ODORS							
PRODUCT							
DATE							
WELL #4							
ODORS							
PRODUCT							
DATE							
WELL #5							
ODORS							
PRODUCT							
DATE							
WELL #6							
ODORS							
PRODUCT							

**CONTINUOUS AUTOMATIC LEAK DETECTION SYSTEM  
MONTHLY VISUAL INSPECTION - (IF APPLICABLE)**

MONTH	OPERATING NORMAL	ALARM	DATE	RESPONSE/COMMENTS
JANUARY				
FEBRUARY				
MARCH				
APRIL				
MAY				
JUNE				
JULY				
AUGUST				
SEPTEMBER				
OCTOBER				
NOVEMBER				
DECEMBER				

**ADDITIONAL COMMENTS:**

When there is a malfunction or an alarm, contact your equipment service department immediately for repairs or recalibration of the system.

FACILITY ADDRESS I. D. #		ABOVEGROUND STORAGE TANK VISUAL INSPECTION CHECKLIST						
MONTH	DATE	SECONDARY CONTAINMENT INTEGRITY	TANK EXTERIOR INTEGRITY	PIPING EXTERIOR INTEGRITY	DRAIN VALVE SECURE	LIQUID ACCUMULATION REMOVAL	STAINED SOIL AROUND CONTAINMENT AREA	INITIALS
JANUARY								
FEBRUARY								
MARCH								
APRIL								
MAY								
JUNE								
JULY								
AUGUST								
SEPTEMBER								
OCTOBER								
NOVEMBER								
DECEMBER								
OTHER COMMENTS:								



## RELEASE DETECTION RESPONSE LEVEL DESCRIPTION

Definition of Release Detection Response Level (RDRL) (62-761 & 62-762) - is the point of measurement, calculation, observation, or level that is established for each individual release detection device or method at which an investigation must be initiated to determine if an incident, release, or discharge has occurred.

---

### ABOVEGROUND STORAGE TANKS

Facility Name \_\_\_\_\_

Emergency Contact \_\_\_\_\_

Address \_\_\_\_\_

Other Contact \_\_\_\_\_

---

#### Release Detection Method:

Monthly Visual Inspection of all regulated above ground storage tank system components, including the tank, piping, and containment.

---

#### Response Level (Indicators):

Excessive wear or other condition which may compromise the integrity of the system. Presence of product or stains on or around the exterior of the tank or piping. Presence of product or stains inside or outside the containment. Observation of leaks any part of the system.

---

#### Investigation & Corrective Action:

The presence of product and stains will be investigated to determine and repair the source. Any cracks, or other physical problems noted, will be corrected. Any leaks will be repaired.

---

#### Reporting:

An Incident Notification Form will be submitted if site conditions exist which indicate a discharge may have occurred. An Incident Notification Form will be submitted if more than 500 gallons or product is released into the containment. A Discharge Reporting Form will be filed with the Local Program if a discharge exceeding 25 gallons of product is discovered outside the containment.

---

## RELEASE DETECTION RESPONSE LEVELS

Facility Name: _____ Address: _____ City: _____ Zip Code: _____	Emergency Contact: _____ Operation Contact: _____ Other: _____ _____
--	---

In accordance with 62-761.600(1)(b) and 62-762.601(1)(b), Florida Administrative Code (F.A.C.) The following Release Detection Response Level (RDRL) has been established for the checked method(s) of Release Detection:

**CHECK ALL THAT APPLY**

RELEASE DETECTION METHOD	RDRL
Statistical Inventory Reconciliation (SIR) with a tank tightness test every three years	One failed SIR report or two consecutive inconclusive SIR reports. A failed tank tightness test.
Continuous Automatic Tank Gauge System	A failed 0.2 gph leak test report/printout.
Automatic Tank Gauge System with a tank tightness test every three years	A failed 0.2 gph leak test report/printout. A failed tank tightness test.
Vacuum Monitoring	A sudden loss of vacuum or a 20% loss of the original vacuum.
Electronic Monitoring of tank interstice	Alarm conditions, audible or visible.
Visual monitoring of tank interstice	Presence of free product or water.
Annual Tank and Line Tightness Tests used with daily inventory reconciliation (available until 10 yrs. after last tank upgrade)	Failed tank and/or line tightness test, unexplained water fluctuations exceeding one inch; significant loss or gain.
Groundwater Monitoring Wells	Presence of free product or sheen. Discharge Report Form must be submitted within 24 hours.
Vapor Monitoring Wells	Vapor concentrations >500 ppm for gasoline, Vapor concentrations >50 ppm for diesel.
Manual Tank Gauging (Only valid for tanks up to 2000 gals)	Readings exceeding the standards described in 62-761.640 Table MTG, F.A.C.
Electronic Monitoring of sumps and/or dispenser liners	Alarm conditions, audible or visible.
Visual Monitoring of sumps and/or dispenser liners	Water above the entrance of double-wall piping or presence of free product.
Line Leak Detector	Tripping/Activation of leak detector.
Annual Line Tightness Test	Failed tightness test

As required by 62.761.200(56) and 62-762.201(69), F.A.C., if the RDRL is measured or observed, we will initiate activities to determine if an incident, release, or discharge has occurred. If within 24 hours we cannot determine if a discharge occurred, an Incident Notification Form will be submitted.

## UST System Inspection Checklist

The Petroleum Equipment Institute (PEI) Tank Installation Committee has produced this checklist as a service to owners/operators of underground storage tanks (USTs). Items on the checklist should only be inspected by individuals knowledgeable of and familiar with UST systems. The frequency of inspections is the minimum standard recommended by the committee. Other factors affecting the frequency of inspection could include such things as monthly throughput, climatic conditions, applicable environmental rules and regulations, manufacturers' recommendations, experience with component performance, or other extenuating circumstances. Some fuel-dispensing system components must be inspected according to requirements established by environmental, fire safety, and/or other authorities having jurisdiction over UST systems. The specific inspection requirements can vary from jurisdiction to jurisdiction. Consult with the local authorities to determine applicable requirements. The Petroleum Equipment Institute hereby expressly disclaims any liability or responsibility for loss or damage resulting from the use of this checklist and for the violation of any federal, state, or municipal regulation with which this checklist may conflict.

KEY: D=Daily, M=Monthly, A=Annually

DISPENSER AREA		D	M	A	Date	Initials
<b>Dispenser Sumps</b>	Clean and Empty - No water, product, debris.		X			
	Sump Integrity - No leaks, cracks, bulges, holes.		X			
	Leak Detection Sensor - Correct position and height.		X			
	Test Leak Detector Sensor			X		
<b>Piping Components</b>	No abnormal appearance of piping or components. (Rust, discoloration, delamination, swelling, disintegration, etc.)		X			
	Test boot (if applicable) pulled back so interstice is not blocked or obstructed.		X			
<b>Product Shear Valve</b>	Properly secured and anchored. Installed at the proper level. No leaks.		X			
	Test for proper operation.			X		
<b>Vapor Shear Valve</b>	<i>(Stage II Vapor Recovery Systems Only)</i>					
	Properly secured and anchored.		X			
	Installed at the proper level.		X			
<b>Flex Connectors</b>	No leaks.		X			
	Not in contact with other components, soil (without corrosion protection) or debris.		X			

LEAK DETECTION EQUIPMENT		D	M	A	Date	Initials
<b>Automatic Tank Gauge</b>	Proper clearance between manhole lid and probe cap.			X		
	ATG equipment operational and no alarms.	X				
	Inspected per manufacturer recommendations.			X		
<b>Interstitial Monitoring</b>	Monitoring ports properly identified.			X		
	Monitoring equipment operational and no alarms.	X				
	Inspected per manufacturer recommendations.			X		
	Manual inspection if used for tank release detection.		X			
<b>Manual Inventory Control</b>	Inspect measuring stick when gauging to be sure the increments are readable. Ensure bottom end has not been worn or cut off and stick is not warped.	X				
	Product dispensers properly calibrated.			X		
	Inventory reconciled.	X	X			
<b>Automatic Line Leak Detector</b>	No leaks in the leak detector.		X			
	No reduced flow, no alarms.	X				
	Function tested.			X		
<b>Soil Vapor Monitoring</b>	Covers clearly marked and secured		X			
	Monitoring equipment operational.	X				
	Inspected per manufacturer recommendations.			X		
<b>Groundwater Monitoring</b>	Covers clearly marked and secured.		X			
	Water present in wells.		X			
	No evidence of product in wells.		X			
	Monitoring equipment operational.	X				
	Inspected per manufacturer recommendations.			X		

**TANK AREA**

		D	M	A	Date	Initials
<b>Tanks</b>	Inspect for water.		X			
<b>Observation Wells</b>	Cover is tightly sealed, properly identified and secured.		X			
	Cap is water tight and locked.		X			
<b>Tank Venting Equipment</b>	Pressure/vacuum vent cap present (if required).		X			
<b>Spill Containment Manholes</b>	Cover is in good condition and properly identified.		X			
	Clean, Empty and Dry - No water, product, dirt, debris.		X			
	Sump Integrity - No cracks, bulges, holes.		X			
	Fill caps tightly sealed & gaskets inspected. Fill adapter tight on riser.		X			
	Drop tubes in place and no obstructions.		X			
<b>Containment Sump Manholes</b>	Cover is in good condition.		X			
<b>Containment Sump</b>	Proper clearance between manhole lid and submersible pump.			X		
	Containment sump lid and gasket in good condition.		X			
	Clean, Empty and Dry - No water, product, dirt, debris.		X			
	Sump Integrity - No cracks, bulges, holes.		X			
	No abnormal appearance of piping. (Rust, discoloration, delamination, swelling, disintegration, etc.)		X			
<b>Sump Sensors</b>	Correct position and height, and operational.		X			
	Test sensor.			X		
<b>Flex Connectors</b>	No leaks.		X			
	Not in contact with other components, soil (without corrosion protection) or debris.		X			
<b>Stage I Vapor Recovery Manholes Two-Point (Dual-Point)</b>	Cover is in good condition and properly identified.		X			
	Sump (if present) Integrity - No cracks, bulges, holes.		X			
	Dry break poppet cap tightly sealed.		X			
	Poppet seals tightly and moves freely when depressed.		X			
<b>Overfill Protection Devices</b>						
<b>Ball Float Valves</b>	Verify in place.			X		
or						
<b>Overflow Prevention Valves (Flapper Valves)</b>	Verify in place.			X		
or						
<b>Overfill Alarms</b>	Functioning properly. (If present.)			X		
<b>Corrosion Protection (If present.)</b>						
<b>Impressed Current Cathodic Protection</b>	Rectifier operating within normal limits.		X			
	Proper operation verified by qualified person.			X		
or						
<b>Galvanic Cathodic Protection System</b>	Proper operation verified by qualified person.			X		

Permission to photocopy this checklist and/or download without making any changes to the content is granted by the Petroleum Equipment Institute.

## Daily UST System Inspection Checklist

The Petroleum Equipment Institute (PEI) Tank Installation Committee has produced this checklist as a service to owners/operators of underground storage tanks (USTs). Items on the checklist should only be inspected by individuals knowledgeable of and familiar with UST systems. The frequency of inspections is the minimum standard recommended by the committee. Other factors affecting the frequency of inspection could include such things as monthly throughput, climatic conditions, applicable environmental rules and regulations, manufacturers' recommendations, experience with component performance, or other extenuating circumstances. Some fuel-dispensing system components must be inspected according to requirements established by environmental, fire safety, and/or other authorities having jurisdiction over UST systems. The specific inspection requirements can vary from jurisdiction to jurisdiction. Consult with the local authorities to determine applicable requirements. The Petroleum Equipment Institute hereby expressly disclaims any liability or responsibility for loss or damage resulting from the use of this checklist and for the violation of any federal, state, or municipal regulation with which this checklist may conflict.

<b>LEAK DETECTION EQUIPMENT</b>		<b>Daily</b>	<b>Date</b>	<b>Initials</b>
<b>Automatic Tank Gauge</b>	ATG equipment operational and no alarms.	<b>X</b>		
<b>Interstitial Monitoring</b>	Monitoring equipment operational and no alarms.	<b>X</b>		
<b>Manual Inventory Control</b>	Inspect measuring stick when gauging to be sure the increments are readable. Ensure bottom end has not been worn or cut off and stick is not warped.	<b>X</b>		
	Inventory reconciled.	<b>X</b>		
<b>Automatic Line Leak Detector</b>	No reduced flow, no alarms.	<b>X</b>		
<b>Soil Vapor Monitoring</b>	Monitoring equipment operational.	<b>X</b>		
<b>Groundwater Monitoring</b>	Monitoring equipment operational.	<b>X</b>		

**Permission to photocopy this checklist and/or download without making any changes to the content is granted by the Petroleum Equipment Institute.**

## Monthly UST System Inspection Checklist

The Petroleum Equipment Institute (PEI) Tank Installation Committee has produced this checklist as a service to owners/operators of underground storage tanks (USTs). Items on the checklist should only be inspected by individuals knowledgeable of and familiar with UST systems. The frequency of inspections is the minimum standard recommended by the committee. Other factors affecting the frequency of inspection could include such things as monthly throughput, climatic conditions, applicable environmental rules and regulations, manufacturers' recommendations, experience with component performance, or other extenuating circumstances. Some fuel-dispensing system components must be inspected according to requirements established by environmental, fire safety, and/or other authorities having jurisdiction over UST systems. The specific inspection requirements can vary from jurisdiction to jurisdiction. Consult with the local authorities to determine applicable requirements. The Petroleum Equipment Institute hereby expressly disclaims any liability or responsibility for loss or damage resulting from the use of this checklist and for the violation of any federal, state, or municipal regulation with which this checklist may conflict.

<b>DISPENSER AREA</b>		<b>Monthly</b>	<b>Date</b>	<b>Initials</b>
<b>Dispenser Sumps</b>	Clean and Empty - No water, product, debris.	<b>X</b>		
	Sump Integrity - No leaks, cracks, bulges, holes.	<b>X</b>		
	Leak Detection Sensor - Correct position and height.	<b>X</b>		
<b>Piping Components</b>	No abnormal appearance of piping or components. (Rust, discoloration, delamination, swelling,	<b>X</b>		
	Test boot (if applicable) pulled back so interstice is not blocked or obstructed.	<b>X</b>		
<b>Product Shear Valve</b>	Properly secured and anchored. Installed at the proper level. No leaks.	<b>X</b>		
<b>Vapor Shear Valve</b>	<i>(Stage II Vapor Recovery Systems Only)</i>			
	Properly secured and anchored.	<b>X</b>		
	Installed at the proper level.	<b>X</b>		
<b>Flex Connectors</b>	No leaks.	<b>X</b>		
	Not in contact with other components, soil (without corrosion protection) or debris.	<b>X</b>		

<b>LEAK DETECTION EQUIPMENT</b>		<b>Monthly</b>	<b>Date</b>	<b>Initials</b>
<b>Interstitial Monitoring</b>	Manual inspection if used for tank release detection.	<b>X</b>		
<b>Manual Inventory Control</b>	Inventory reconciled.	<b>X</b>		
<b>Automatic Line Leak Detector</b>	No leaks in the leak detector.	<b>X</b>		
<b>Soil Vapor Monitoring</b>	Covers clearly marked and secured	<b>X</b>		
<b>Groundwater Monitoring</b>	Covers clearly marked and secured.	<b>X</b>		
	Water present in wells.	<b>X</b>		
	No evidence of product in wells.	<b>X</b>		

## TANK AREA

		Monthly	Date	Initials
<b>Tanks</b>	Inspect for water.	X		
<b>Observation Wells</b>	Cover is tightly sealed, properly identified and secured.	X		
	Cap is water tight and locked.	X		
<b>Tank Venting Equipment</b>	Pressure/vacuum vent cap present (if required).	X		
<b>Spill Containment Manholes</b>	Cover is in good condition and properly identified.	X		
	Clean, Empty and Dry - No water, product, dirt, debris.	X		
	Sump Integrity - No cracks, bulges, holes.	X		
	Fill caps tightly sealed & gaskets inspected. Fill adapter tight on riser.	X		
	Drop tubes in place and no obstructions.	X		
<b>Containment Sump Manholes</b>	Cover is in good condition.	X		
<b>Containment Sump</b>	Containment sump lid and gasket in good condition.	X		
	Clean, Empty and Dry - No water, product, dirt, debris.	X		
	Sump Integrity - No cracks, bulges, holes.	X		
	No abnormal appearance of piping. (Rust, discoloration, delamination, swelling, disintegration, etc.)	X		
<b>Sump Sensors</b>	Correct position and height, and operational.	X		
<b>Flex Connectors</b>	No leaks.	X		
	Not in contact with other components, soil (without corrosion protection) or debris.	X		
<b>Stage I Vapor Recovery Manholes Two-Point (Dual-Point)</b>	Cover is in good condition and properly identified.	X		
	Sump (if present) Integrity - No cracks, bulges, holes.	X		
	Dry break poppet cap tightly sealed.	X		
	Poppet seals tightly and moves freely when depressed.	X		
<b>Corrosion Protection</b> (If present.)				
<b>Impressed Current Cathodic Protection</b>	Rectifier operating within normal limits.	X		

Permission to photocopy this checklist and/or download without making any changes to the content is granted by the Petroleum Equipment Institute.

## Annual UST System Inspection Checklist

The Petroleum Equipment Institute (PEI) Tank Installation Committee has produced this checklist as a service to owners/operators of underground storage tanks (USTs). Items on the checklist should only be inspected by individuals knowledgeable of and familiar with UST systems. The frequency of inspections is the minimum standard recommended by the committee. Other factors affecting the frequency of inspection could include such things as monthly throughput, climatic conditions, applicable environmental rules and regulations, manufacturers' recommendations, experience with component performance, or other extenuating circumstances. Some fuel-dispensing system components must be inspected according to requirements established by environmental, fire safety, and/or other authorities having jurisdiction over UST systems. The specific inspection requirements can vary from jurisdiction to jurisdiction. Consult with the local authorities to determine applicable requirements. The Petroleum Equipment Institute hereby expressly disclaims any liability or responsibility for loss or damage resulting from the use of this checklist and for the violation of any federal, state, or municipal regulation with which this checklist may conflict.

<b>DISPENSER AREA</b>		Annual	Date	Initials
<b>Dispenser Sumps</b>	Test Leak Detector Sensor	X		
<b>Product Shear Valve</b>	Test for proper operation.	X		

<b>LEAK DETECTION EQUIPMENT</b>		Annual	Date	Initials
<b>Automatic Tank Gauge</b>	Proper clearance between manhole lid and probe cap.	X		
	Inspected per manufacturer recommendations.	X		
<b>Interstitial Monitoring</b>	Monitoring ports properly identified.	X		
	Inspected per manufacturer recommendations.	X		
<b>Manual Inventory Control</b>	Product dispensers properly calibrated.	X		
<b>Automatic Line Leak Detector</b>	Function tested.	X		
<b>Soil Vapor Monitoring</b>	Inspected per manufacturer recommendations.	X		
<b>Groundwater Monitoring</b>	Inspected per manufacturer recommendations.	X		

<b>TANK AREA</b>		Annual	Date	Initials
<b>Containment Sump</b>	Proper clearance between manhole lid and submersible pump.	X		
<b>Sump Sensors</b>	Test sensor.	X		
<b>Overfill Protection Devices</b>				
<b>Ball Float Valves</b>	Verify in place.	X		
or				
<b>Overflow Prevention Valves (Flapper Valves)</b>	Verify in place.	X		
or				
<b>Overfill Alarms</b>	Functioning properly. (If present.)	X		
<b>Corrosion Protection (If present.)</b>				
<b>Impressed Current Cathodic Protection</b>	Proper operation verified by qualified person.	X		
or				
<b>Galvanic Cathodic Protection System</b>	Proper operation verified by qualified person.	X		

Permission to photocopy this checklist and/or download without making any changes to the content is granted by the Petroleum Equipment Institute.



## NOTES

## NOTES

**This handbook is provided as a general guide.**

For specific regulation requirements refer to the underground and aboveground storage tank system rules (Chapter 62-761 and Chapter 62-762, Florida Administrative Code) which are located at the district and county offices, and at the storage tank program website ([www.dep.state.fl.us/waste/categories/tanks/default.htm](http://www.dep.state.fl.us/waste/categories/tanks/default.htm)).

## REMEMBER

The State's economic engine is driven by the State's ecological engine, so help protect our ground and drinking water by properly maintaining your storage tank system.

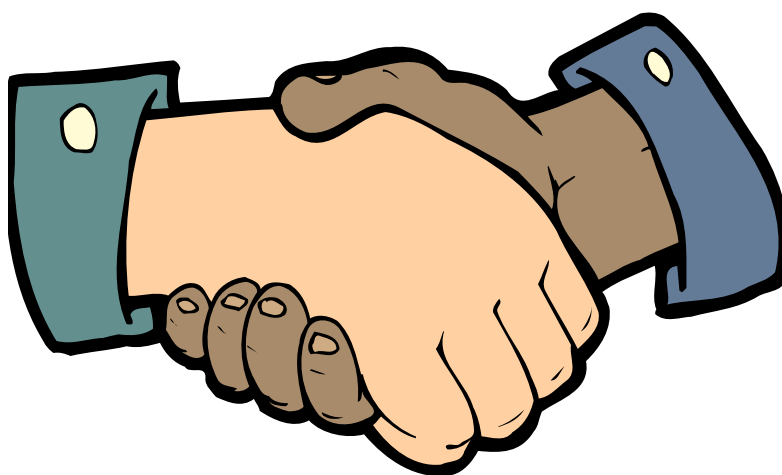

You make a difference working towards a cleaner environment. **THANKS!** We can succeed.



This publication can be made available in large print, tape cassette or braille by request.

This public document was promulgated at a cost of \$0,000.00, or \$0.000 per copy, to inform the public about storage tank facilities inspections.

©2005 by the Florida Department of Environmental Protection